

SINGLE POWER SUPPLY DUAL OPERATIONAL AMPLIFIERS

<R> DESCRIPTION

The μ PC1251GR-9LG, μ PC1251MP-KAA, μ PC358GR-9LG are dual operational amplifiers which are designed to operate for a single power supply. It includes features of low-voltage operation, a common-mode input voltage that range from V^- (GND) level, an output from a V^- (GND) level that is determined by the output stage of class C push-pull circuit and a 50 μ A(TYP.) constant current, and a low current consumption.

In addition, this can operate at both positive and negative power supply and it can be extensively used in various amplifier circuits.

The μ PC1251GR-9LG, μ PC1251MP-KAA which expands temperature type is suited for wide operating ambient temperature use, and μ PC358GR-9LG is used for general purposes.

A DC parameter selection that is compatible to operational amplifiers is also available.

μ PC451GR-9LG, μ PC324GR-9LG which are quad types with the same circuit configuration are also available as series of operational amplifiers.

<R> FEATURES

- Input Offset Voltage ± 2 mV (TYP.)
- Input Offset Current ± 5 nA (TYP.)
- Large Signal Voltage Gain 100000 (TYP.)
- Small Package
- Internal frequency compensation
- Output short-circuit protection

The mounting area is reduced to 40% or 66% compared to the conventional 8-pin plastic SOP as shown in the following diagram.

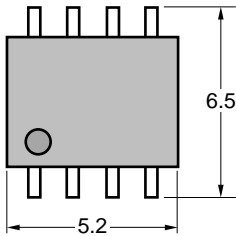
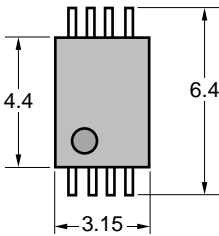
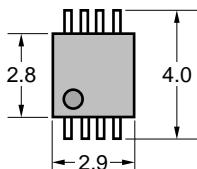
Package	Standard SOP	TSSOP	TSSOP (2.8 x 2.9)
Subject part number	μ PC1251G2, μ PC358G2	μ PC1251GR-9LG, μ PC358GR-9LG	μ PC1251MP-KAA
Outline comparison			
(Mounting area ratio)	(100%)	(60%)	(34%)

The information in this document is subject to change without notice. Before using this document, please confirm that this is the latest version.

Not all products and/or types are available in every country. Please check with an NEC Electronics sales representative for availability and additional information.

<R> ORDERING INFORMATION

Part Number	Selected Grade	Package	Package Type
μPC1251GR-9LG-E1-A ^{Note}	Standard	8-pin plastic TSSOP (5.72 mm(225))	<ul style="list-style-type: none"> • 12 mm wide embossed taping • Pin 1 on draw-out side
μPC1251GR-9LG-E2-A ^{Note}	Standard	8-pin plastic TSSOP (5.72 mm(225))	<ul style="list-style-type: none"> • 12 mm wide embossed taping • Pin 1 at take-up side
μPC1251GR(5)-9LG-E1-A ^{Note}	DC parameter selection	8-pin plastic TSSOP (5.72 mm(225))	<ul style="list-style-type: none"> • 12 mm wide embossed taping • Pin 1 on draw-out side
μPC1251GR(5)-9LG-E2-A ^{Note}	DC parameter selection	8-pin plastic TSSOP (5.72 mm(225))	<ul style="list-style-type: none"> • 12 mm wide embossed taping • Pin 1 at take-up side
μPC1251MP-KAA-E1-A ^{Note}	Standard	8-pin plastic TSSOP (2.8 x 2.9)	<ul style="list-style-type: none"> • 12 mm wide embossed taping • Pin 1 on draw-out side
μPC1251MP-KAA-E2-A ^{Note}	Standard	8-pin plastic TSSOP (2.8 x 2.9)	<ul style="list-style-type: none"> • 12 mm wide embossed taping • Pin 1 at take-up side
μPC1251MP(5)-KAA-E1-A ^{Note}	DC parameter selection	8-pin plastic TSSOP (2.8 x 2.9)	<ul style="list-style-type: none"> • 12 mm wide embossed taping • Pin 1 on draw-out side
μPC1251MP(5)-KAA-E2-A ^{Note}	DC parameter selection	8-pin plastic TSSOP (2.8 x 2.9)	<ul style="list-style-type: none"> • 12 mm wide embossed taping • Pin 1 at take-up side
μPC358GR-9LG-E1-A ^{Note}	Standard	8-pin plastic TSSOP(5.72 mm(225))	<ul style="list-style-type: none"> • 12 mm wide embossed taping • Pin 1 on draw-out side
μPC358GR-9LG-E2-A ^{Note}	Standard	8-pin plastic TSSOP(5.72 mm(225))	<ul style="list-style-type: none"> • 12 mm wide embossed taping • Pin 1 at take-up side
μPC358GR(5)-9LG-E1-A ^{Note}	DC parameter selection	8-pin plastic TSSOP(5.72 mm(225))	<ul style="list-style-type: none"> • 12 mm wide embossed taping • Pin 1 on draw-out side
μPC358GR(5)-9LG-E2-A ^{Note}	DC parameter selection	8-pin plastic TSSOP(5.72 mm(225))	<ul style="list-style-type: none"> • 12 mm wide embossed taping • Pin 1 at take-up side

Note Pb-free (This product does not contain Pb in the external electrode and other parts.)

EQUIVALENT CIRCUIT (1/2 Circuit)

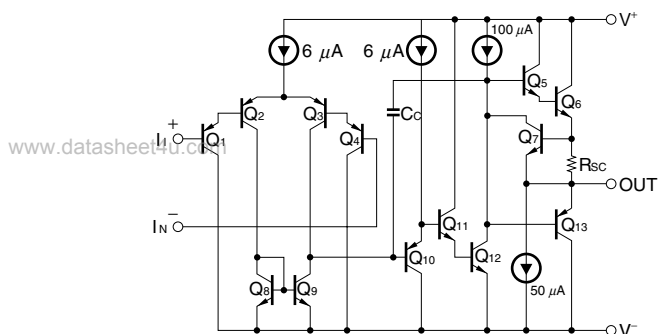

<R> PIN CONFIGURATION (Marking side)

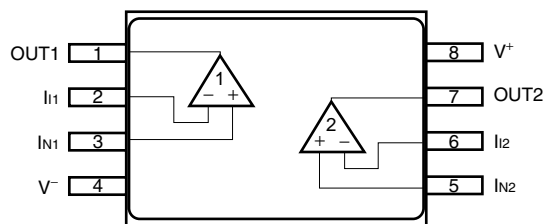

<R> ABSOLUTE MAXIMUM RATINGS (TA = 25°C)

Parameter	Symbol	μ PC1251GR-9LG, μ PC1251GR(5)-9LG	μ PC1251MP-KAA, μ PC1251MP(5)-KAA	μ PC358GR-9LG, μ PC358GR(5)-9LG	Unit
Voltage between V ⁺ and V ⁻ ^{Note1}	V ⁺ - V ⁻	-0.3 to +32			V
Differential Input Voltage	V _{ID}	±32			V
Input Voltage ^{Note2}	V _I	V ⁻ - 0.3 to V ⁻ + 32			V
Output applied Voltage ^{Note3}	V _O	V ⁻ - 0.3 to V ⁺ + 0.3			V
Total Power Dissipation ^{Note4}	P _T	440			mW
Output Short Circuit Duration ^{Note5}	t _s	Indefinite			s
Operating Ambient Temperature	T _A	-40 to +125		-40 to +85	°C
Storage Temperature	T _{stg}	-55 to +150		-55 to +125	°C

Note1. Note that reverse connections of the power supply may damage ICs.

2. The input voltage is allowed to input without damage or destruction independent of the magnitude of V⁺. Either input signal is not allowed to go negative by more than 0.3 V. In addition, the input voltage that operates normally as an operational amplifier is within the Common Mode Input Voltage range of an electrical characteristic.
3. A range where input voltage can be applied to an output pin externally with no deterioration or damage to the feature (characteristic). The input voltage can be applied regardless of the electric supply voltage. This specification which includes the transition state such as electric power ON/OFF must be kept.
4. This is the value of when the glass epoxy substrate (size: 100 mm x 100 mm, thickness: 1 mm, 15% of the substrate area where only one side is copper foiled is filling wired) is mounted.

Note that restrictions will be made to the following conditions for each product, and the derating ratio depending on the operating ambient temperature.

μPC1251GR-9LG: Derate at -5.5 mW/°C when T_A > 69°C.

(Junction - ambient thermal resistance R_{th(J-A)} = 183°C/W)

μPC1251MP-KAA: Derate at -4.8 mW/°C when T_A > 58°C.

(Junction - ambient thermal resistance R_{th(J-A)} = 208°C/W)

μPC358GR-9LG: Derate at -5.5 mW/°C when T_A > 44°C.

(Junction - ambient thermal resistance R_{th(J-A)} = 183°C/W)

5. Short circuits from the output to V⁺ can cause destruction. Pay careful attention to the total power dissipation not to exceed the absolute maximum ratings, **Note 4**.

RECOMMENDED OPERATING CONDITIONS

Parameter	Symbol	MIN.	TYP.	MAX.	Unit
Power Supply Voltage (Split)	V^{\pm}	±1.5		±15	V
Power Supply Voltage ($V^- = \text{GND}$)	V^+	+3		+30	V

www.R>> **ELECTRICAL CHARACTERISTICS**

μPC1251GR-9LG, μPC1251MP-KAA, μPC358GR-9LG ($T_A = 25^{\circ}\text{C}$, $V^+ = +5\text{ V}$, $V^- = \text{GND}$)

Parameter	Symbol	Conditions	MIN.	TYP.	MAX.	Unit
Input Offset Voltage	V_{IO}	$R_S = 0\ \Omega$		±2	±7	mV
Input Offset Current	I_{IO}			±5	±50	nA
Input Bias Current ^{Note1}	I_B			14	250	nA
Large Signal Voltage Gain	A_V	$R_L \geq 2\ \text{k}\Omega$	25000	100000		
Circuit Current ^{Note2}	I_{CC}	$R_L = \infty$, $I_O = 0\ \text{A}$		0.7	1.2	mA
Common Mode Rejection Ratio	CMR		65	70		dB
Supply Voltage Rejection Ratio	SVR		65	100		dB
Output Voltage Swing	V_O	$R_L = 2\ \text{k}\Omega$ (Connect to GND)	0		$V^+ - 1.5$	V
Common Mode Input Voltage Range	V_{ICM}		0		$V^+ - 1.5$	V
Output Source Current	$I_{O\ \text{SOURCE}}$	$V_{IN(+)} = +1\ \text{V}$, $V_{IN(-)} = 0\ \text{V}$	20	40		mA
Output Sink Current	$I_{O\ \text{SINK1}}$	$V_{IN(-)} = +1\ \text{V}$, $V_{IN(+)} = 0\ \text{V}$	10	20		mA
	$I_{O\ \text{SINK2}}$	$V_{IN(-)} = +1\ \text{V}$, $V_{IN(+)} = 0\ \text{V}$, $V_O = 200\ \text{mV}$	12	50		μA
Channel Separation		$f = 1\ \text{to}\ 20\ \text{kHz}$		120		dB

μPC1251GR(5)-9LG, μPC1251MP(5)-KAA, μPC358GR(5)-9LG ($T_A = 25^{\circ}\text{C}$, $V^+ = +5\ \text{V}$, $V^- = \text{GND}$)

Parameter	Symbol	Conditions	MIN.	TYP.	MAX.	Unit
Input Offset Voltage	V_{IO}	$R_S = 0\ \Omega$		±2	±3	mV
Input Offset Current	I_{IO}			±5	±50	nA
Input Bias Current ^{Note1}	I_B			14	60	nA
Large Signal Voltage Gain	A_V	$R_L \geq 2\ \text{k}\Omega$	50000	100000		
Circuit Current ^{Note2}	I_{CC}	$R_L = \infty$, $I_O = 0\ \text{A}$		0.7	0.9	mA
Common Mode Rejection Ratio	CMR		65	70		dB
Supply Voltage Rejection Ratio	SVR		65	100		dB
Output Voltage Swing	V_O	$R_L = 2\ \text{k}\Omega$ (Connect to GND)	0		$V^+ - 1.5$	V
Common Mode Input Voltage Range	V_{ICM}		0		$V^+ - 1.4$	V
Output Source Current	$I_{O\ \text{SOURCE}}$	$V_{IN(+)} = +1\ \text{V}$, $V_{IN(-)} = 0\ \text{V}$	30	40		mA
Output Sink Current	$I_{O\ \text{SINK1}}$	$V_{IN(-)} = +1\ \text{V}$, $V_{IN(+)} = 0\ \text{V}$	15	20		mA
	$I_{O\ \text{SINK2}}$	$V_{IN(-)} = +1\ \text{V}$, $V_{IN(+)} = 0\ \text{V}$, $V_O = 200\ \text{mV}$	30	50	70	μA
Channel Separation		$f = 1\ \text{to}\ 20\ \text{kHz}$		120		dB

Notes1. The input bias current flows in the direction where the IC flows out because the first stage is configured with a PNP transistor.

2. This is a current that flows in the internal circuit. This current will flow irrespective of the channel used.

<R> TYPICAL PERFORMANCE CHARACTERISTICS ($T_A = 25^\circ\text{C}$, TYP.) (Reference value)

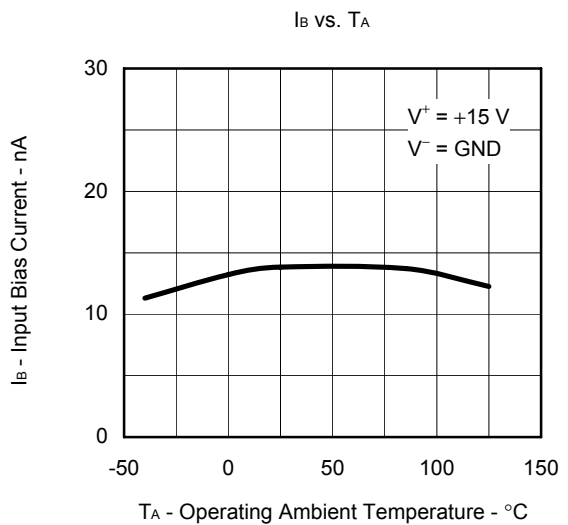
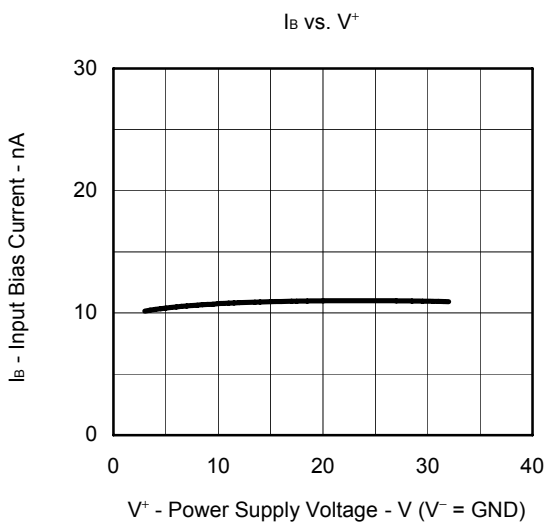
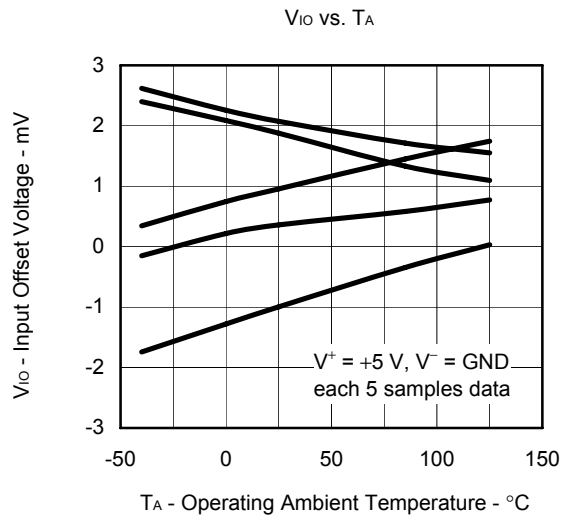
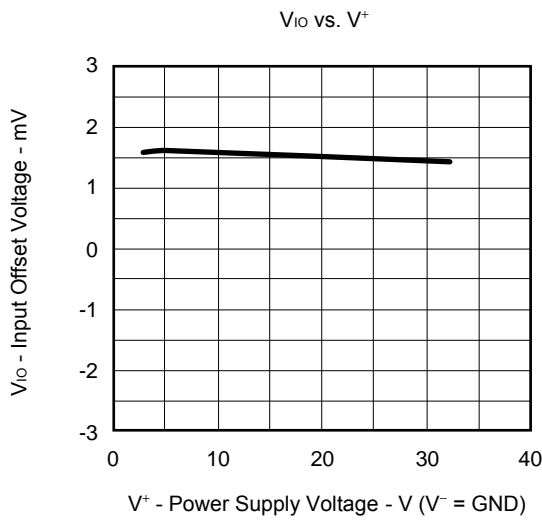
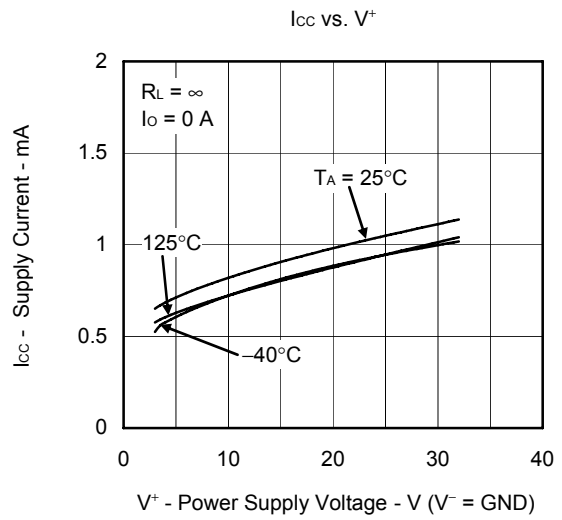
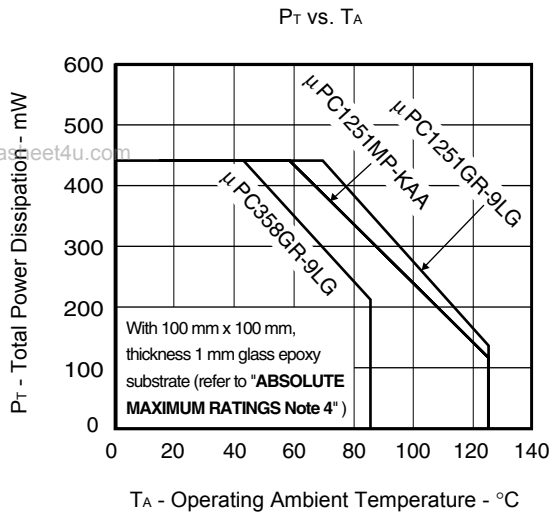

$I_{O\text{ SHORT}}$ vs. T_A

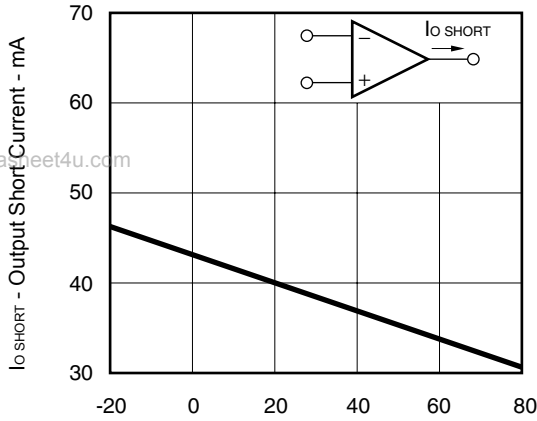

www.dataSheet4u.com

T_A - Operating Ambient Temperature - °C

A_v vs. V^+

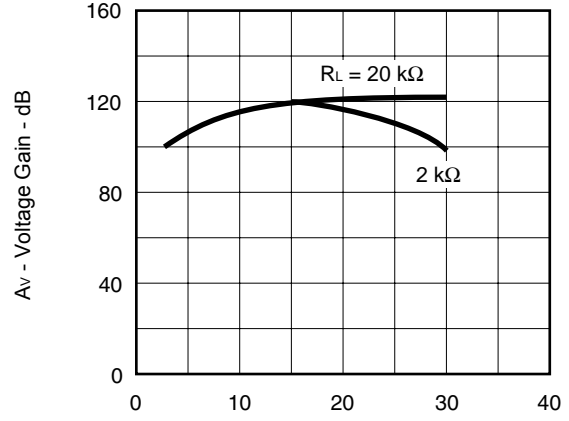

V^+ - Power Supply Voltage - V ($V^- = \text{GND}$)

A_v, ϕ vs. f

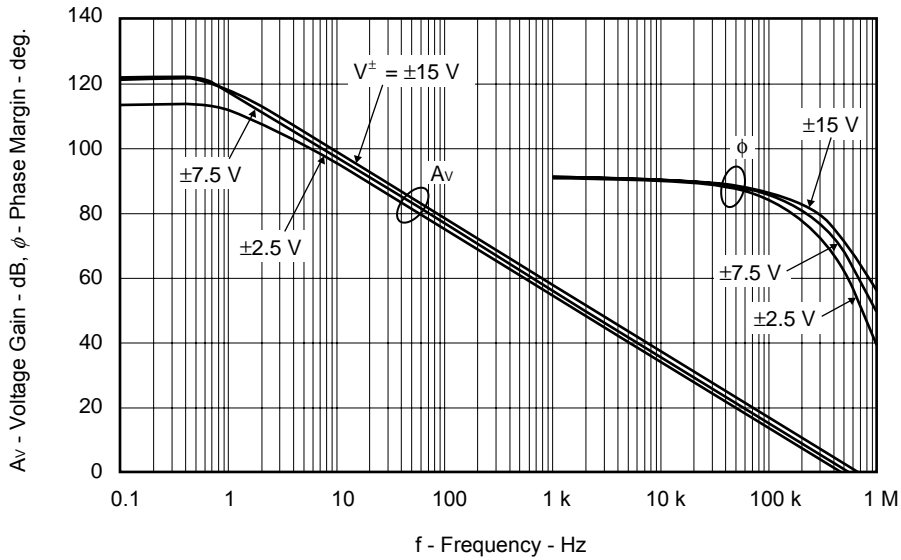

V_o vs. f

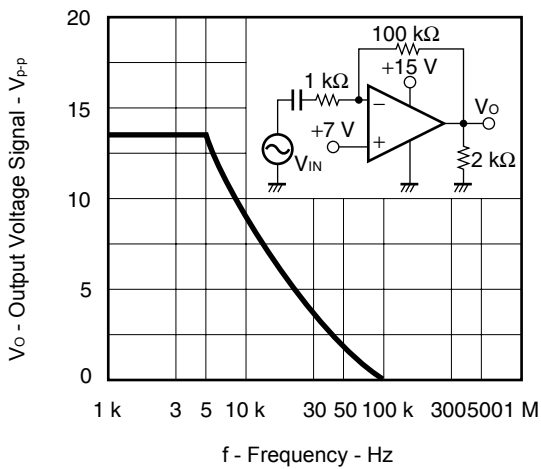

CMR vs. f

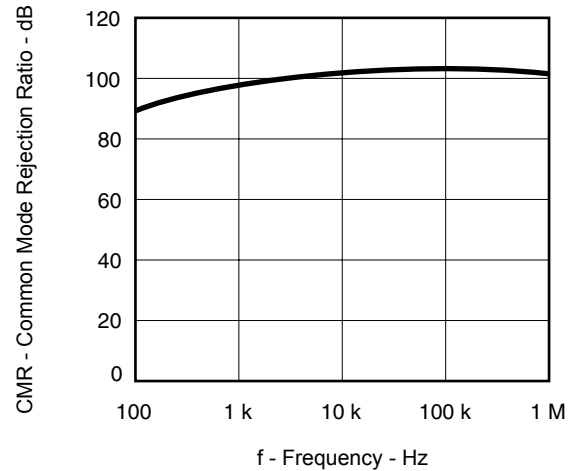

PULSE RESPONSE

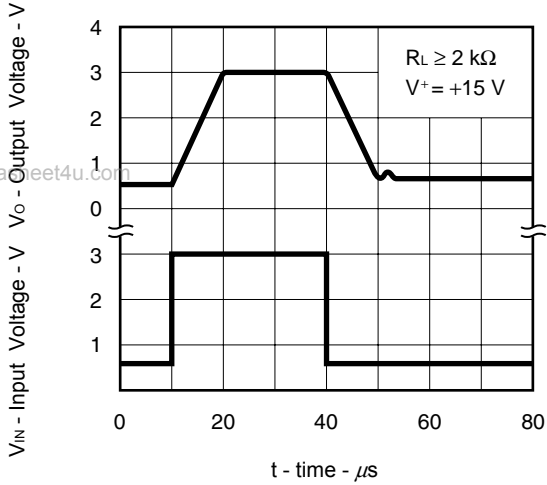

SR - T_A

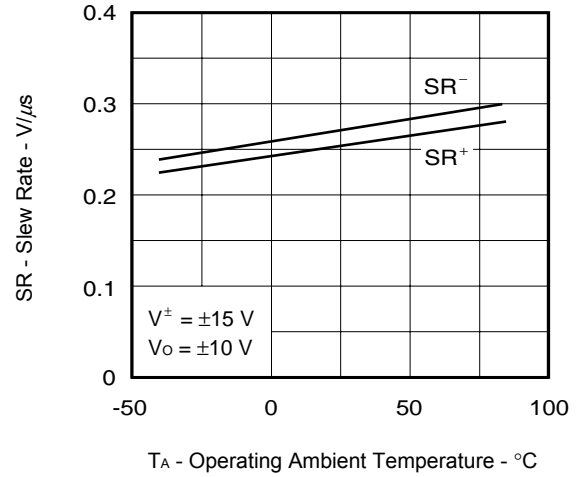

V_O vs. I_O SINK

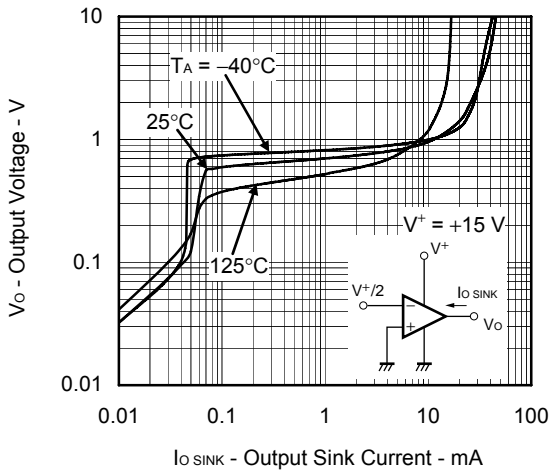

ΔV_O vs. I_O SOURCE

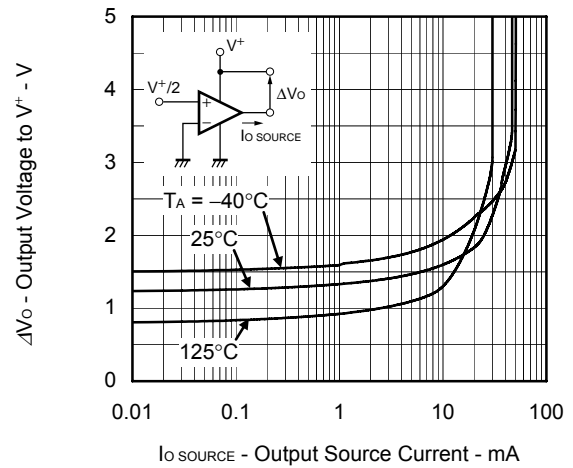

<R> PRECAUTIONS FOR USE

O The process of unused circuits

If there is an unused circuit, the following connection is recommended.

www.datasheet4u.com

Process example of unused circuits

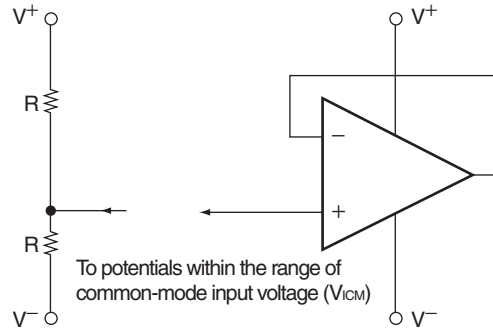

Remark A midpoint potential of V^+ and V^- is applied to this example.

O Ratings of input/output pin voltage

When the voltage of input/output pin exceeds the absolute maximum rating, it may cause degradation of characteristics or damages, by a conduction of a parasitic diode within an IC. In addition, when the input pin may be lower than V^- , or the output pin may exceed the power supply voltage, it is recommended to make a clamp circuit by a diode whose forward voltage is low (e.g.: Schottky diode) for protection.

O Range of common-mode input voltage

When the supply voltage does not meet the condition of electrical characteristics, the range of common-mode input voltage is as follows.

V_{ICM} (TYP.): V^- to $V^+ - 1.5$ (V) ($T_A = 25^\circ\text{C}$)

During designing, temperature characteristics for use with allowance.

O The maximum output voltage

The range of the TYP. value of the maximum output voltage when the supply voltage does not meet the condition of electrical characteristics is as follows:

V_{Om^+} (TYP.): $V^+ - 1.5$ (V) ($T_A = 25^\circ\text{C}$), V_{Om^-} (TYP.) ($I_{o\text{ SINK}} \leq 50 \mu\text{A}$): Approx. V^- (V) ($T_A = 25^\circ\text{C}$)

During designing, consider variations in characteristics and temperature characteristics for use with allowance.

In addition, also note that the output voltage range ($V_{Om^+} - V_{Om^-}$) becomes narrow when an output current increases.

O Operation of output

This IC consist an output level of a class C push-pull. Therefore, when a load resistance is connected to the midpoint potential of V^+ , V^- , a crossover distortion occurs at the transition state of output current flow direction (source, sink).

O Handling of ICs

When stress is added to ICs due to warpage or bending of a board, the characteristic fluctuates due to piezoelectric effect. Therefore, pay attention to warpage or bending of a board.

PACKAGE DRAWINGS (Unit: mm)

8-PIN PLASTIC TSSOP (5.72mm (225))

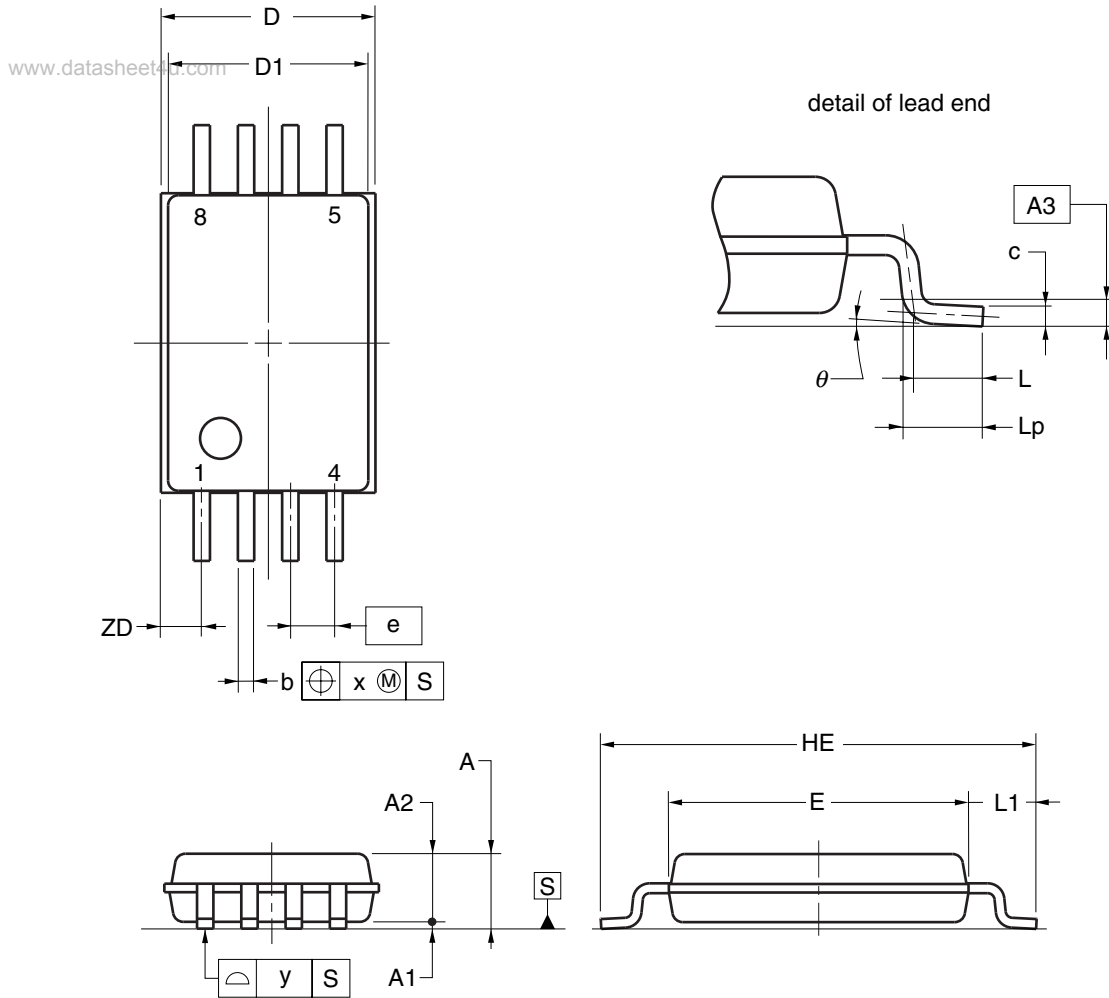

(UNIT:mm)

ITEM	DIMENSIONS
D	3.15±0.15
D1	3.00±0.10
E	4.40±0.10
HE	6.40±0.20
A	1.20 MAX.
A1	0.10±0.05
A2	1.00±0.05
A3	0.25
b	0.24 ^{+0.06} _{-0.05}
c	0.145±0.055
L	0.50
Lp	0.60±0.15
L1	1.00±0.20
θ	3° ^{+5°} _{-3°}
e	0.65
x	0.10
y	0.10
ZD	0.60

P8GR-65-9LG

NOTE

Each lead centerline is located within 0.10mm of its true position at maximum material condition.

© NEC Electronics Corporation 2005

<R> 8-PIN PLASTIC TSSOP(2.8x2.9)

www.datasheet4u.com

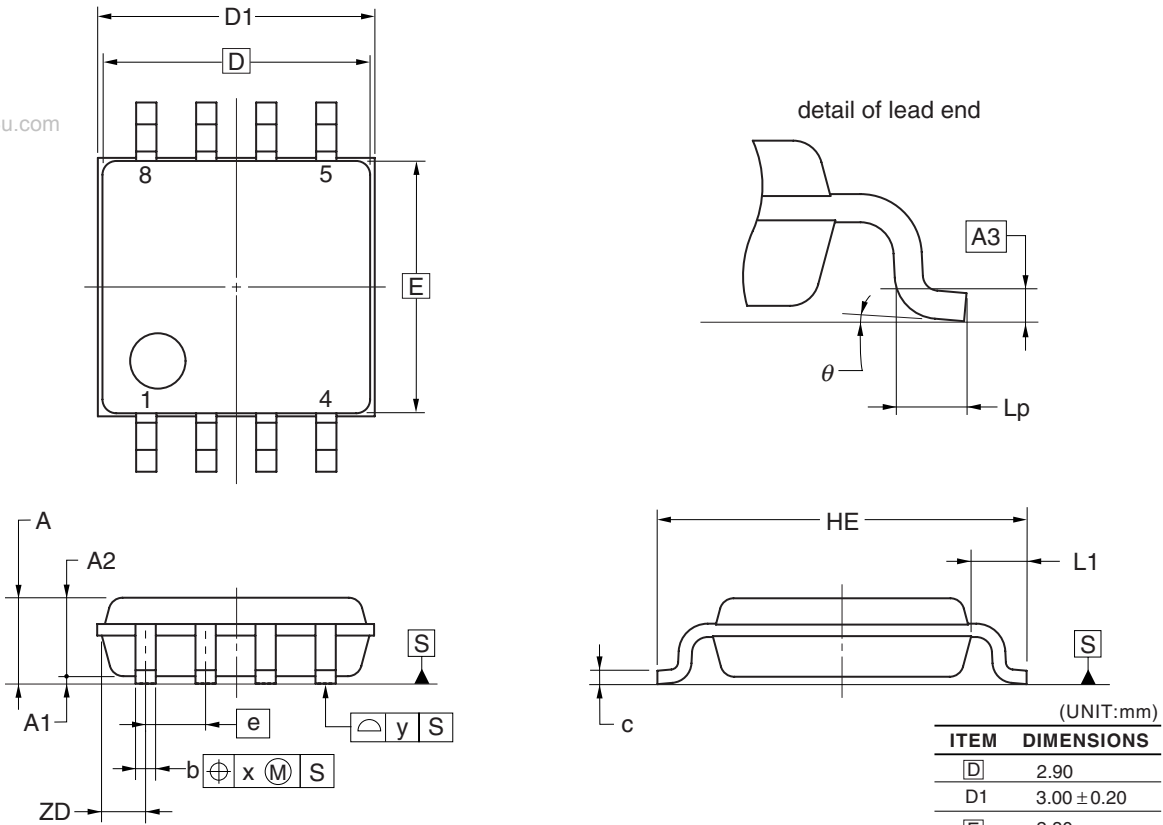

NOTE

Each lead centerline is located within 0.10 mm of its true position at maximum material condition.

© NEC Electronics Corporation 2006

<R> **RECOMMENDED SOLDERING CONDITIONS**

The μPC1251GR-9LG, μPC1251MP-KAA, μPC358GR-9LG should be soldered and mounted under the following recommended conditions.

For soldering methods and conditions other than those recommended below, contact an NEC Electronics sales representative.

For technical information, see the following website.

Semiconductor Device Mount Manual (<http://www.necel.com/pkg/en/mount/index.html>)

Type of Surface Mount Device

μPC1251GR-9LG-A^{Note}, μPC1251GR(5)-9LG-A^{Note},

μPC358GR-9LG-A^{Note}, μPC358GR(5)-9LG-A^{Note}: 8-pin plastic TSSOP (5.72 mm (225))

μPC1251MP-KAA-A^{Note}, μPC1251MP(5)-KAA-A^{Note}: 8-pin plastic TSSOP (2.8 x 2.9)

Process	Conditions	Symbol
Infrared ray reflow	Peak temperature: 260°C, Reflow time: 60 seconds or less (at 220°C or higher), Maximum number of reflow processes: 3 times.	IR60-00-3
Wave soldering	Solder temperature: 260°C or below, Flow time: 10 seconds or less, Maximum number of flow processes: 1 time, Pre-heating temperature: 120°C or below (Package surface temperature).	WS60-00-1
Partial heating method	Pin temperature: 350°C or below, Heat time: 3 seconds or less (Per each side of the device).	P350

Note Pb-free (This product does not contain Pb in external electrode and other parts.)

Caution Apply only one kind of soldering condition to a device, except for “partial heating method”, or the device will be damaged by heat stress.

Remark Flux: Rosin flux with low chlorine (0.2 Wt% or below) recommended.

<R> **REFERENCE DOCUMENTS**

Document Name	Document No.
QUALITY GRADES ON NEC SEMICONDUCTOR DEVICES	C11531E
SEMICONDUCTOR DEVICE MOUNT MANUAL	http://www.necel.com/pkg/en/mount/index.html
NEC SEMICONDUCTOR DEVICE RELIABILITY/QUALITY CONTROL SYSTEM-STANDARD LINEAR IC	IEI-1212
REVIEW OF QUALITY AND RELIABILITY HANDBOOK	C12769E
NEC SEMICONDUCTOR DEVICE RELIABILITY/QUALITY CONTROL SYSTEM	C10983E

- **The information in this document is current as of December, 2007. The information is subject to change without notice. For actual design-in, refer to the latest publications of NEC Electronics data sheets or data books, etc., for the most up-to-date specifications of NEC Electronics products. Not all products and/or types are available in every country. Please check with an NEC Electronics sales representative for availability and additional information.**
- No part of this document may be copied or reproduced in any form or by any means without the prior written consent of NEC Electronics. NEC Electronics assumes no responsibility for any errors that may appear in this document.
- NEC Electronics does not assume any liability for infringement of patents, copyrights or other intellectual property rights of third parties by or arising from the use of NEC Electronics products listed in this document or any other liability arising from the use of such products. No license, express, implied or otherwise, is granted under any patents, copyrights or other intellectual property rights of NEC Electronics or others.
- Descriptions of circuits, software and other related information in this document are provided for illustrative purposes in semiconductor product operation and application examples. The incorporation of these circuits, software and information in the design of a customer's equipment shall be done under the full responsibility of the customer. NEC Electronics assumes no responsibility for any losses incurred by customers or third parties arising from the use of these circuits, software and information.
- While NEC Electronics endeavors to enhance the quality, reliability and safety of NEC Electronics products, customers agree and acknowledge that the possibility of defects thereof cannot be eliminated entirely. To minimize risks of damage to property or injury (including death) to persons arising from defects in NEC Electronics products, customers must incorporate sufficient safety measures in their design, such as redundancy, fire-containment and anti-failure features.
- NEC Electronics products are classified into the following three quality grades: "Standard", "Special" and "Specific".
The "Specific" quality grade applies only to NEC Electronics products developed based on a customer-designated "quality assurance program" for a specific application. The recommended applications of an NEC Electronics product depend on its quality grade, as indicated below. Customers must check the quality grade of each NEC Electronics product before using it in a particular application.
 - "Standard": Computers, office equipment, communications equipment, test and measurement equipment, audio and visual equipment, home electronic appliances, machine tools, personal electronic equipment and industrial robots.
 - "Special": Transportation equipment (automobiles, trains, ships, etc.), traffic control systems, anti-disaster systems, anti-crime systems, safety equipment and medical equipment (not specifically designed for life support).
 - "Specific": Aircraft, aerospace equipment, submersible repeaters, nuclear reactor control systems, life support systems and medical equipment for life support, etc.

The quality grade of NEC Electronics products is "Standard" unless otherwise expressly specified in NEC Electronics data sheets or data books, etc. If customers wish to use NEC Electronics products in applications not intended by NEC Electronics, they must contact an NEC Electronics sales representative in advance to determine NEC Electronics' willingness to support a given application.

(Note)

- (1) "NEC Electronics" as used in this statement means NEC Electronics Corporation and also includes its majority-owned subsidiaries.
- (2) "NEC Electronics products" means any product developed or manufactured by or for NEC Electronics (as defined above).