



**DDR SDRAM Module 256Mbyte (32Mx64bit), based on16Mx8,4Banks,  
4K Ref., SMM,  
Part No. HDD32M64F8K**

## GENERAL DESCRIPTION

The HDD32M64F8K is a 32M x 64 bit Double Data Rate(DDR) Synchronous Dynamic RAM high-density memory module. The module consists of sixteen CMOS 16M x 8 bit with 4banks DDR SDRAMs in 66pin TSOP-II 400mil packages and 2K EEPROM in 8-pin TSSOP package on a 200-pin glass-epoxy. Four 0.1uF decoupling capacitors are mounted on the printed circuit board in parallel for each DDR SDRAM. The HSD32M64F8K is a SMM(Stackable Memory Module type) .Synchronous design allows precise cycle control with the use of system clock. Data I/O transactions are possible on both edges of DQS. Range of operating frequencies, programmable latencies and burst lengths allows the same device to be useful for a variety of high bandwidth, high performance memory system applications. All module components may be powered from a single 2.5V DC power supply and all inputs and outputs are SSTL\_2 compatible.

## FEATURES

- Part Identification

HDD32M64F8K – 10A : 100MHz (CL=2)

HDD32M64F8K – 13A : 133MHz (CL=2)

HDD32M64F8K – 13B : 133MHz (CL=2.5)

- 256MB(32Mx64) Unbuffered DDR SMM based on 16Mx8 DDR SDRSM
- 2.5V ± 0.2V VDD and VDDQ power supply
- Auto & self refresh capability (4096 Cycles/64ms)
- All input and output are compatible with SSTL\_2 interface
- Data(DQ), Data strobes and write masks latched on the rising and falling edges of the clock
- All Addresses and control inputs except Data(DQ), Data strobes and Data masks latched on the rising edges of the clock
- MRS cycle with address key programs
  - Latency (Access from column address) : 2, 2.5
  - Burst length : 2, 4, 8
  - Data scramble : Sequential & Interleave
- Data(DQ), Data strobes and write masks latched on the rising and falling edges of the clock
- All Addresses and control inputs except Data(DQ), Data strobes and Data masks latched on the rising edges of the clock
- The used device is 4M x 8bit x 4Banks DDR SDRAM

## PIN ASSIGNMENT

P1						P2					
PIN	Symbol	PIN	Symbol	PIN	Symbol	PIN	Symbol	PIN	Symbol	PIN	Symbol
1	/CS0	35	DQ15	69	NC	1	VDDQ	35	DQ17	69	NC(DQS8)
2	/CS1	36	DQ14	70	DQS1	2	A3	36	DQ18	70	DQS3
3	VSS	37	VDDQ	71	DQS5	3	VSS	37	VDDQ	71	DQS6
4	CKE0	38	DQ13	72	VDD	4	A2	38	DQ19	72	VDD
5	CKE1	39	DQ12	73	NC	5	A1	39	DQ20	73	DQ56
6	NC	40	DQ11	74	DQ39	6	A0	40	DQ21	74	DQ57
7	VDD	41	VSS	75	DQ38	7	VDD	41	VSS	75	DQ58
8	CK0	42	DQ10	76	VSS	8	A10	42	DQ22	76	VSS
9	CK1	43	DQ9	77	DQ37	9	A11	43	DQ23	77	DQ59
10	NC	44	DQ8	78	DQ36	10	BA0	44	NC(CB6)	78	DQ60
11	VSS	45	VDD	79	VDDQ	11	VSS	45	VDD	79	VDDQ
12	NC	46	*SA0	80	DQ35	12	BA1	46	NC(CB4)	80	DQ61
13	DM0	47	*SA1	81	DQ34	13	DM2	47	NC(CB2)	81	DQ62
14	DM4	48	VSS	82	DQ33	14	DM6	48	VSS	82	DQ63
15	VDDQ	49	*SA2	83	VSS	15	VDDQ	49	NC(CB0)	83	VSS
16	NC	50	VDDQ	84	DQ32	16	NC	50	VDDQ	84	DQ55
17	NC	51	VDD	85	DQ40	17	NC	51	VDD	85	DQ54
18	VSS	52	/RAS	86	DQ41	18	VSS	52	A4	86	DQ53
19	NC	53	VSS	87	VDDQ	19	DQS7	53	VSS	87	VDDQ
20	DQS0	54	/CAS	88	DQ42	20	DQS2	54	A5	88	DQ52
21	DQS4	55	/CK0	89	DQ43	21	NC	55	A6	89	DQ51
22	VDD	56	/CK1	90	DQ44	22	VDD	56	A7	90	DQ50
23	NC	57	VDD	91	VSS	23	DQ31	57	VDD	91	VSS
24	DQ0	58	/CK2	92	DQ45	24	DQ30	58	A8	92	DQ49
25	DQ1	59	CK2	93	DQ46	25	DQ29	59	A9	93	DQ48
26	VSS	60	/WE	94	DQ47	26	VSS	60	NC(A12)	94	NC(CB7)
27	DQ2	61	VSS	95	*SCL	27	DQ28	61	VSS	95	VDD
28	DQ3	62	NC	96	*WP	28	DQ27	62	DM3	96	NC(CB5)
29	VDDQ	63	DM1	97	*VSPD	29	VDDQ	63	DM7	97	NC(CB3)
30	DQ4	64	DM5	98	VSS	30	DQ26	64	NC(DM8)	98	VSS
31	DQ5	65	VDDQ	99	*SDA	31	DQ25	65	VDDQ	99	NC(CB1)
32	DQ6	66	NC	100	VDDIN	32	DQ24	66	NC	100	VDD
33	VSS	67	VREF			33	VSS	67	NC(A13)		
34	DQ7	68	VSS			34	DQ16	68	VSS		

\* These pins should be NC in the system which does not support SPD

PIN	PIN DESCRIPTION	PIN	PIN DESCRIPTION
A0~A11	Address input	VDD	Power supply(2.5V)
BA0~BA1	Bank Select Address	VDDQ	Power supply for DQs(2.5V)
DQ0~DQ63	Data input/output	VREF	Power supply for reference
CB0~CB7	Check bit(Data input/output)	VSPD	Serial EEPROM Power supply(3.3)
DQS0~DQS7	Data Strobe input/output	VSS	Ground
DM0~DM7	Data-in Mask	SA0~SA2	Address in EEPROM
CK0~CK2,/CK0~/CK2	Clock input	SDA	Serial data I/O
CKE0~CKE1	Clock enable input	SCL	Serial clock
/CS0~/CS1	Chip Select input	WP	Write protection
/RAS	Row Address strobe	VDDIN	VDD identification flag
/CAS	Column Address strobe	NC	No connection

**FUNCTIONAL BLOCK DIAGRAM**

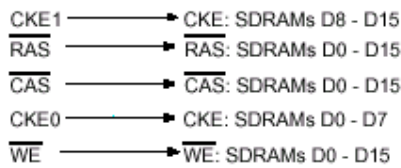
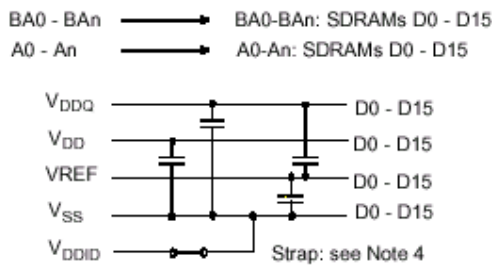
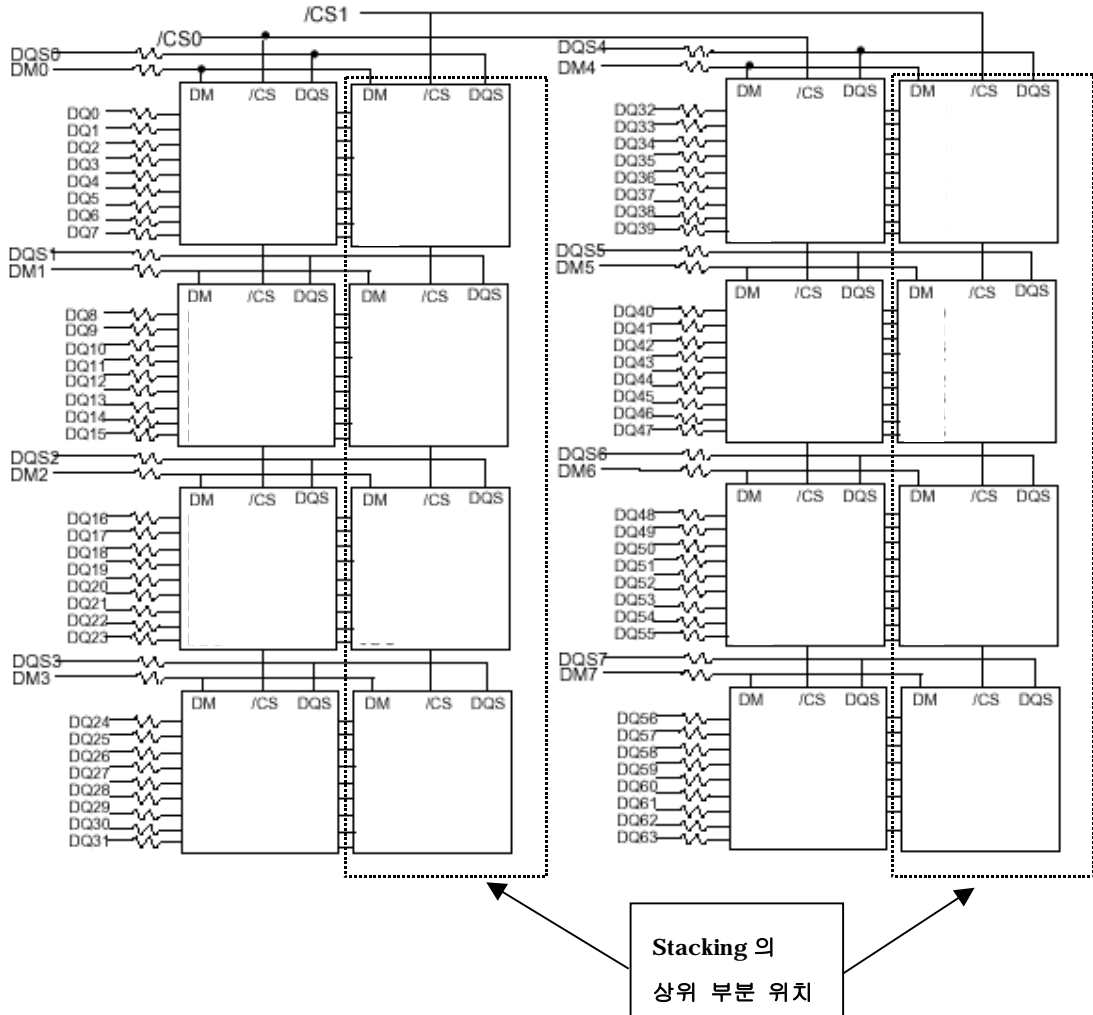

Clock Wiring	
Clock Input	SDRAMs
CK0/CK0	6 SDRAMs
CK1/CK1	4 SDRAMs
CK2/CK2	6 SDRAMs

**Notes:**  
 DQ wiring may differ from that described in this drawing; however DQ/DM/DQS relationships are maintained as shown.  
 VDDID strap connections  
 (for memory device VDD, VDDQ) :  
 Strap out (:open) : VDD=VDDQ  
 Strap In (Vss) : VDD≠ VDDQ

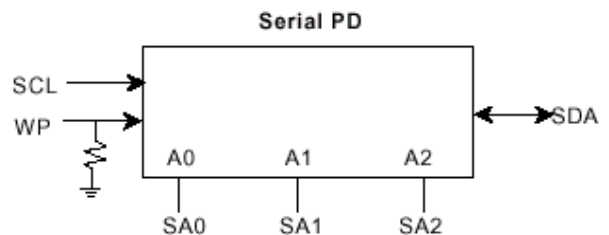

## PIN FUNCTION DESCRIPTION

Pin	Name	Input Function
CK, /CK	Clock	CK and CK are differential clock inputs. All address and control input signals are sampled on the positive edge of CK and negative edge of CK. Output (read) data is referenced to both edges of CK. Internal clock signals are derived from CK/CK.
CKE	Clock Enable	CKE HIGH activates, and CKE LOW deactivates internal clock signals, and device input buffers and output drivers. Deactivating the clock provides PRECHARGE POWER-DOWN and SELF REFRESH operation (all banks idle), or ACTIVE POWER-DOWN(row ACTIVE in any bank). CKE is synchronous for all functions except for disabling outputs, which is achieved asynchronously. Input buffers, excluding CK, CK and CKE are disabled during power-down and self refresh modes, providing low standby power. CKE will recognizean LVCMOS LOW level prior to VREF being stable on power-up.
/CS	Chip Select	CS enables(registered LOW) and disables(registered HIGH) the command decoder. All commands are masked when CS is registered HIGH. CS provides for external bank selection on systems with multiple banks. CS is considered part of the command code.
A0 ~ A11	Address	Row/column addresses are multiplexed on the same pins. Row address : RA0 ~ RA11, Column address : CA0 ~ CA9
BA0 ~ BA1	Bank select address	BA0 and BA1 define to which bank an ACTIVE, READ, WRITE or PRE-CHARGE command is being applied.
/RAS	Row address strobe	Latches row addresses on the positive going edge of the CLK with /RAS low. Enables row access & precharge.
/CAS	Columnaddress strobe	Latches column addresses on the positive going edge of the CLK with /CAS low. Enables column access.
/WE	Write enable	Enables write operation and row precharge. Latches data in starting from /CAS, /WE active.
DQS0 ~ 7	Data Strobe	Output with read data, input with write data. Edge-aligned with read data, centered in write data. Used to capture write data.
DM0~7	Input Data Mask	DM is an input mask signal for write data. Input data is masked when DM is sampled HIGH along with that input data during a WRITE access. DM is sampled on both edges of DQS. DM pins include dummy loading internally, to matches the DQ and DQS load-ing.
DQ0 ~ 63	Data input/output	Data inputs/outputs are multiplexed on the same pins.
WP	Write Protection	WP pin is connected to Vcc. When WP is "high", EEPROM Programming will be inhibited and the entire memory will be write-protected.
VDDQ	Supply	DQ Power Supply : +2.5V ± 0.2V.
VDD	Supply	Power Supply : +2.5V ± 0.2V (device specific).
VSS	Supply	DQ Ground.
VREF	Supply	SSTL_2 reference voltage.

**ABSOLUTE MAXIMUM RATINGS**

PARAMETER	SYMBOL	RATING	UNTE
Voltage on any pin relative to Vss	V <sub>IN</sub> , V <sub>OUT</sub>	-0.5 ~ 3.6	V
Voltage on V <sub>DD</sub> supply relative to Vss	V <sub>DD</sub>	-1.0 ~ 3.6	V
Voltage on V <sub>DDQ</sub> supply relative to Vss	V <sub>DDQ</sub>	-0.5 ~ 3.6	V
Storage temperature	T <sub>STG</sub>	-55 ~ +150	°C
Power dissipation	P <sub>D</sub>	16.0	W
Short circuit current	I <sub>OS</sub>	50	mA

**Notes:** Operation at above absolute maximum rating can adversely affect device reliability

**DC OPERATING CONDITIONS**

(Recommended operating conditions (Voltage referenced to Vss = 0V, T<sub>A</sub> = 0 to 70°C))

PARAMETER	SYMBOL	MIN	MAX	UNIT	NOTE
Supply Voltage	V <sub>DD</sub>	2.3	2.7	V	
I/O Supply Voltage	V <sub>DDQ</sub>	2.3	2.7	V	
I/O Reference Voltage	V <sub>REF</sub>	1.15	1.35	V	1
I/O Termination Voltage(system)	V <sub>TT</sub>	V <sub>REF</sub> - 0.04	V <sub>REF</sub> + 0.04	V	2
Input High Voltage	V <sub>IH</sub> (DC)	V <sub>REF</sub> + 0.15	V <sub>REF</sub> + 0.3	V	
Input Low Voltage	V <sub>IL</sub> (DC)	-0.3	V <sub>REF</sub> - 0.15	V	
Input Voltage Level, CK and /CK inputs	V <sub>IN</sub> (DC)	-0.3	V <sub>DDQ</sub> + 0.3	V	
Input Differential Voltage, CK and /CK inputs	V <sub>ID</sub> (DC)	0.3	V <sub>DDQ</sub> + 0.6	V	
Input leakage current	I <sub>LI</sub>	-2	2	uA	3
Output leakage current	I <sub>OZ</sub>	-5	5	uA	
Output High current (V <sub>OUT</sub> = 1.95V)	I <sub>OH</sub>	-16.8		mA	
Output Low current (V <sub>OUT</sub> = 0.35V)	I <sub>OL</sub>	16.8		mA	

**Notes :**

- Typically, the value of V<sub>REF</sub> is expected to be about 0.5\* V<sub>DD</sub> of the transmitting device.  
V<sub>REF</sub> is expected to track variation in V<sub>DDQ</sub>.
- Peak to peak AC noise on V<sub>REF</sub> may not exceed 2% V<sub>REF</sub> (DC).
- V<sub>TT</sub> of the transmitting device must track V<sub>REF</sub> of the receiving device.

**CAPACITANCE** (V<sub>DD</sub> = min to max, V<sub>DDQ</sub> = 2.5V to 2.7V, T<sub>A</sub> = 25°C, f = 100MHz)

DESCRIPTION	SYMBOL	MIN	MAX	UNITS
	<b>L</b>			
Input capacitance(A0~A11, BA0~BA1, /RAS, /CAS, /WE)	C <sub>IN1</sub>	93	107	pF
Input capacitance(CKE0,CKE1)	C <sub>IN2</sub>	63	77	pF
Input capacitance(/CS0~/CS1)	C <sub>IN3</sub>	58	72	pF
Input capacitance(CLK0, CLK1,CLK2)	C <sub>IN4</sub>	30	45	pF
Input capacitance(DM0~DM7)	C <sub>IN5</sub>	10	15	pF
Data input/output capacitance (DQ0 ~ DQ63, DQS0~DQS7)	C <sub>OUT1</sub>	10	15	pF

## DC CHARACTERISTICS

(Recommended operating condition unless otherwise noted,  $V_{DD} = 2.5V$ ,  $T = 25^{\circ}C$ )

PARAMETER	SYMBOL	TEST CONDITION	VERSION			UNIT	NOTE
			-10A	-13A	-13B		
Operating current (One bank active)	$I_{DD1}$	Burst length = 2 $t_{RC} \geq t_{RC}(\min)$ , $CL=2.5$ $I_{OUT} = 0mA$ , Active-Read-Presharge	1520	1600	1600	mA	
Precharge standby current in power-down mode	$I_{DD2P}$	$CKE \leq V_{IL}(\max)$ $t_{CK} = t_{CK}(\min)$ , All banks idle	48	56	56	mA	
Precharge standby current in non power-down mode	$I_{DD2N}$	$CKE \geq V_{IH}(\min)$ $/CS \geq V_{IH}(\min)$ , $t_{CK} = t_{CK}(\min)$	288	320	320	mA	
Active standby current in power-down mode	$I_{DD3P}$	All banks idle, $CKE \leq V_{IL}(\max)$ , $t_{CK} = t_{CK}(\min)$	480	560	560	mA	
Active standby current in non power-down mode (One bank active)	$I_{DD3N}$	One bank, Active-Read-Presharge, $t_{RC} = t_{RAS}(\max)$ , $t_{CK} = t_{CK}(\min)$	720	800	800	mA	
Operating current (Read)	$I_{DD4R}$	Burst length = 2 $t_{RC} = t_{RC}(\min)$ , $I_{OUT} = 0mA$ ,	1840	2160	2160	mA	
		$CL=2$ , 5 $CL=2$					
Operating current (Write)	$I_{DD4W}$	Burst length = 2 $t_{RC} = t_{RC}(\min)$	1840	2240	2240	mA	
		$CL=2$ , 5 $CL=2$					
Auto refresh current	$I_{DD5}$	$t_{RC} \geq t_{REF}(\min)$	2720	2880	2880	mA	
Self refresh current	$I_{DD6}$	$CKE \leq 0.2V$	32	32	32	mA	

## AC OPERATING CONDITIONS

PARAMETER	SYMBOL	MIN	MAX	UNIT	NOTE
Input High (Logic 1) Voltage, DQ, DQS and DM signals	$V_{IH} (AC)$	$V_{REF} + 0.35$			
Input Low (Logic 0) Voltage, DQ, DQS and DM signals.	$V_{IL} (AC)$		$V_{REF} - 0.35$	V	
Input Differential Voltage, CK and CK inputs	$V_{ID} (AC)$	0.7	$V_{DDQ} + 0.6$	V	1
Input Crossing Point Voltage, CK and CK inputs	$V_{IX} (AC)$	$0.5 * V_{DDQ} - 0.2$	$0.5 * V_{DDQ} + 0.2$	V	2

## Notes:

1.  $V_{ID}$  is the magnitude of the difference between the input level on CK and the input on CK.
2. The value of  $V_{IX}$  is expected to equal  $0.5 * V_{DDQ}$  of the transmitting device and must track variations in the DC level of the same

**AC OPERATING TEST CONDITIONS**

PARAMETER	VALUE	UNIT	NOTE
Input reference voltage for Clock	$0.5 * V_{DDQ}$	V	
Input signal maximum peak swing	1.5	V	
Input signal minimum slew rate	1.0	V	
Input Levels( $V_{IH}/V_{IL}$ )	$V_{REF}+0.35/V_{REF}$	V	
Input timing measurement reference level	$V_{REF}$	V	
Output timing measurement reference level	$V_{TT}$	V	
Output load condition	See Load Circuit	V	

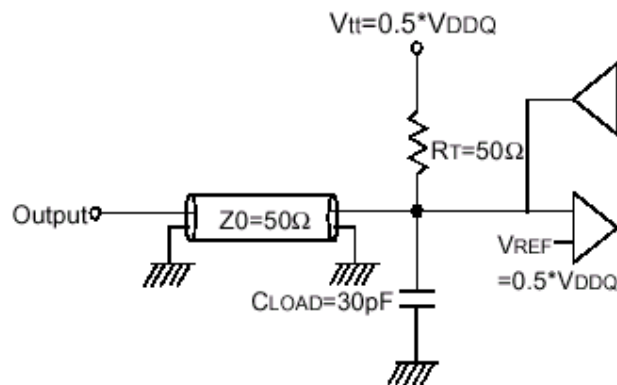

(Fig. 1) Output Load Circuit (SSTL\_2)

**AC CHARACTERISTICS** (These AC characteristics were tested on the Component)

PARAMETER	SYMBOL	DDR200		DDR266A		DDR266B		UNIT	NOTE	
		-10A		-13A		-13B				
		MIN	MAX	MIN	MAX	MIN	MAX			
Row cycle time	$t_{RC}$	70		65		65		ns	1	
Refresh row cycle time	$t_{RFC}$	80		75		75		ns	1,2	
Row active time	$t_{RAS}$	48	120K	45	120K	45	120K	ns	1,2	
/RAS to /CAS delay	$t_{RCD}$	20		20		20		ns	3	
Row precharge time	$t_{RP}$	20		20		20		ns	3	
Row active to Row active delay	$t_{RRD}$	15		15		15		ns	3	
Write recovery time	$t_{WR}$	2		2		2		$t_{CK}$	3	
Last data in to Read command	$t_{CDLR}$	1		1		1		$t_{CK}$	2	
Col. address to Col. address delay	$t_{CCD}$	1		1		1		$t_{CK}$		
Clock cycle time	CL=2.0	$t_{CK}$	10	12	7.5	12	10	12	ns	
	CL=2.5			12	7.5	12	7.5	12	ns	

Clock high level width	$t_{CH}$	0.45	0.55	0.45	0.55	0.45	0.55	$t_{CK}$	
Clock low level width	$t_{CL}$	0.45	0.55	0.45	0.55	0.45	0.55	$t_{CK}$	
DQS-out access time from CK/CK	$t_{DQSCK}$	-0.8	+0.8	-0.75	+0.75	-0.75	+0.75	ns	
Output data access time from CK/CK	$t_{AC}$	-0.8	+0.8	-0.75	+0.75	-0.75	+0.75	ns	
Data strobe edge to output data edge	$t_{DQSQ}$	-	+0.6	-	+0.5	-	+0.5	ns	
Read Preamble	$t_{RPRE}$	0.9	1.1	0.9	1.1	0.9	1.1	$t_{CK}$	
Read Postamble	$t_{RPST}$	0.4	0.6	0.4	0.6	0.4	0.6	$t_{CK}$	
Data out high impedance time from CK-/CK	$t_{HZQ}$	-0.8	+0.8	-0.75	+0.75	-0.75	+0.75	ns	2
CK to valid DQS-in	$t_{DQSS}$	0.75	1.25	0.75	1.25	0.75	1.25	$t_{CK}$	
DQS-in setup time	$t_{WPRES}$	0		0		0		ns	3
DQS-in hold time	$t_{WPREH}$	0.25		0.25		0.25		$t_{CK}$	
DQS-in falling edge to CK rising-setup time	$t_{DSS}$	0.2		0.2		0.2		$t_{CK}$	
DQS-in falling edge to CK rising hold time	$t_{DSH}$	0.2		0.2		0.2		$t_{CK}$	
DQS-in high level width	$t_{DQSH}$	0.35		0.35		0.35		$t_{CK}$	
DQS-in low level width	$t_{DQSL}$	0.35		0.35		0.35		$t_{CK}$	
DQS-in cycle time	$t_{DSC}$	0.9	1.1	0.9	1.1	0.9	1.1	$t_{CK}$	
Address and Control Input setup time	$t_{IS}$	1.1		0.9		0.9		ns	
Address and Control Input hold time	$t_{IH}$	1.1		0.9		0.9		ns	
Mode register set cycle time	$t_{MRD}$	16		15		15		ns	
DQ & DM setup time to DQS	$t_{DS}$	0.6		0.5		0.5		ns	
DQ & DM hold time to DQS	$t_{DH}$	0.6		0.5		0.5		ns	
DQ & DM input pulse width	$t_{DIPW}$	2		1.75		1.75		ns	
Power down exit time	$t_{PDEX}$	10		10		10		ns	
Exit self refresh to write command	$t_{XSW}$	116		95				ns	
Exit self refresh to bank active command	$t_{XSA}$	80		75		75		ns	
Exit self refresh to read command	$t_{XSR}$	200		200		200		Cycle	
Refresh interval time	$T_{REF}$	15.6		15.6		15.6		us	1
Output DQS valid window	$T_{QH}$	0.35		0.35		0.35		$t_{CK}$	
DQS write postamble time	$T_{WPST}$	0.25		0.25		0.25		$t_{CK}$	4

**Notes :**

1. Maximum burst refresh of 8.
2.  $t_{HZQ}$  transitions occurs in the same access time windows as valid data transitions. These parameters are not referenced to a specific voltage level, but specify when the device output is no longer driving.
3. The specific requirement is that DQS be valid(High-Low) on or before this CK edge. The case shown(DQS going from High\_Z to logic Low) applies when no writes were previously in progress on the bus. If a previous write was in progress, DQS could be High at this time, depending on  $t_{DQSS}$ .



- The maximum limit for this parameter is not a device limit. The device will operate with a great value for this parameter, but system performance (bus turnaround) will degrade accordingly.

**SIMPLIFIED TRUTH TABLE**

COMMAND		CKE n-1	CKE n	/CS	/RAS	/CAS	/WE	DM	BA 0,1	A10/AP	A11 A9~A0	NOTE	
Register	Extended MRS	H	X	L	L	L	L	X	OP code			1,2	
Register	Mode register set	H	X	L	L	L	L	X	OP code			1,2	
Refresh	Auto refresh		H	H	L	L	L	H	X	X		3	
	Self refresh	Entry		L									
		Exit	L	H	L	H	H	H	X	X		3	
						H	X	X	X				3
Bank active & row addr.		H	X	L	L	H	H	X	V	Row address			
Read & column address	Auto precharge disable		H	X	L	H	L	H	X	V	L	Column Address (A0 ~ A9)	4
	Auto precharge enable										H		
Write & column address	Auto precharge disable		H	X	L	H	L	H	X	V	L	Column Address (A0 ~ A9)	4
	Auto precharge enable							L					
Burst Stop		H	X	L	H	H	L	X	X			7	
Precharge	Bank selection		H	X	L	L	H	L	X	V	L	X	
	All banks									X	H		
Clock suspend or active power down	Entry		H	L	H	X	X	X	X	X			
	Exit				L	H	X	X				X	X
Precharge power down mode	Entry		H	L	H	X	X	X	X	X			
					L	H	H	H					
	Exit		L	H	H	X	X	X	X				
					L	V	V	V					
DM		H	X					V	X		8		
No operation command		H	X	H	X	X	X	X	X				
				L	H	H	H						

(V=Valid, X=Don't care, H=Logic high, L=Logic low)

**Notes :**

- OP Code : Operand code  
A0 ~ A11 & BA0 ~ BA1 : Program keys. (@ MRS)
- MRS can be issued only at all banks precharge state.  
A new command can be issued after 2 CLK cycles of MRS.
- Auto refresh functions are as same as CBR refresh of DRAM.  
The automatical precharge without row precharge command is meant by "Auto".  
Auto/self refresh can be issued only at all banks precharge state.
- BA0 ~ BA1 : Bank select addresses.  
If both BA0 and BA1 are "Low" at read, write, row active and precharge, bank A is selected.  
If both BA0 is "Low" and BA1 is "High" at read, write, row active and precharge, bank B is selected.  
If both BA0 is "High" and BA1 is "Low" at read, write, row active and precharge, bank C is selected.  
If both BA0 and BA1 are "High" at read, write, row active and precharge, bank D is selected.  
If A10/AP is "High" at row precharge, BA0 and BA1 is ignored and all banks are selected.

5. During burst read or write with auto precharge, new read/write command can not be issued.  
Another bank read/write command can be issued after the end of burst.  
New row active of the associated bank can be issued at  $t_{RP}$  after the end of burst.
6. Burst stop command is valid at every burst length.
7. DM sampled at the rising and falling edges of the DQS and Data-in are masked at the both edges  
(Write DM latency is 0)

**PACKAGING INFORMATION**

Unit : mm

**Front -Side**

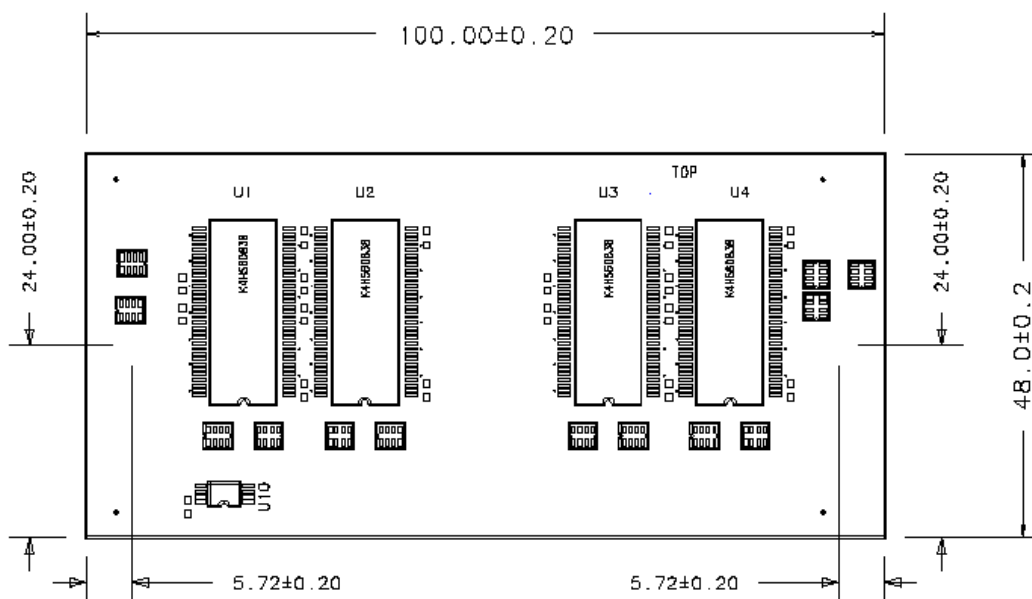

**Rear-Side**

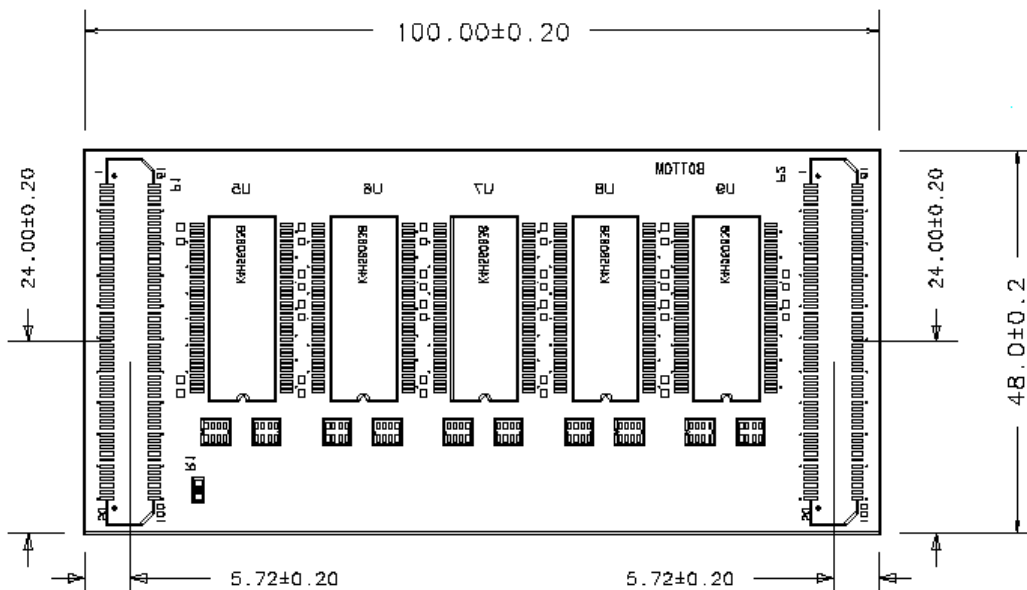

## ORDERING INFORMATION

Part Number	Density	Org.	Package	Ref.	Vcc	MODE	MAX.frq
HDD32M64F8K-10A	256MByte	32M x 64	200PIN SMM	4K	2.5V	DDR	100MHz/CL2
HDD32M64F8K-13A	256MByte	32M x 64	200PIN SMM	4K	2.5V	DDR	133MHz/CL2
HDD32M64F8K-13B	256MByte	32M x 64	200PIN SMM	4K	2.5V	DDR	133MHz/CL2.5