



Micro Commercial Components

Micro Commercial Components
20736 Marilla Street Chatsworth
CA 91311

Phone: (818) 701-4933

Fax: (818) 701-4939

BC337-16/25/40 BC338-16/25/40

Features

- Capable of 0.625Watts of Power Dissipation.
- Collector-current 0.8A
- Collector-base Voltage : $V_{CBO}=50V(BC337)$, $V_{CBO}=30V(BC338)$
- Case Material: Molded Plastic. UL Flammability Classification Rating 94V-0

Maximum Ratings

- Operating temperature : $-55^{\circ}C$ to $+150^{\circ}C$
- Storage temperature : $-55^{\circ}C$ to $+150^{\circ}C$

Electrical Characteristics @ 25°C Unless Otherwise Specified

Symbol	Parameter	Min	Max	Units
--------	-----------	-----	-----	-------

OFF CHARACTERISTICS

$V_{(BR)CEO}$	Collector-Emitter Breakdown Voltage ($I_C=10mA$, $I_B=0$)		---	Vdc
		BC337 BC338	45 25	
$V_{(BR)CBO}$	Collector-Base Breakdown Voltage ($I_C=100\mu A$, $I_E=0$)		---	Vdc
		BC337 BC338	50 30	
$V_{(BR)EBO}$	Collector-Emitter Breakdown Voltage ($I_E=10\mu A$, $I_C=0$)	5.0	---	Vdc
I_{CBO}	Collector Cutoff Current ($V_{CB}=45Vdc$, $I_E=0$)		0.1	μA
		BC337 BC338	---	0.1
I_{CEO}	Collector Cutoff Current ($V_{CE}=40Vdc$, $I_B=0$)		0.2	μA
		BC337 BC338	---	0.2
I_{EBO}	Emitter Cutoff Current ($V_{EB}=4.0Vdc$, $I_C=0$)	---	0.1	μA

ON CHARACTERISTICS

$h_{FE(2)}$	DC Current Gain ($I_C=300mA$, $V_{CE}=1.0Vdc$)	60	---	--
$V_{CE(sat)}$	Collector-Emitter Saturation Voltage ($I_C=500mA$, $I_B=50mA$)	---	0.7	Vdc
$V_{BE(sat)}$	Base-Emitter Saturation Voltage ($I_C=500mA$, $I_B=50mA$)	---	1.2	Vdc

SMALL SIGNAL CHARACTERISTICS

f_T	Current-Gain-Bandwidth Product ($V_{CE}=5.0V$, $f=100MHz$, $I_C=10mA$)	210	---	MHz
-------	---	-----	-----	-----

hFE CLASSIFICATION

Classification	16	25	40
$h_{FE(1)}$	100~250	160~400	250~630
Marking Code	A 011	B 011	C 011

NPN Plastic-Encapsulate Transistors

TO-92

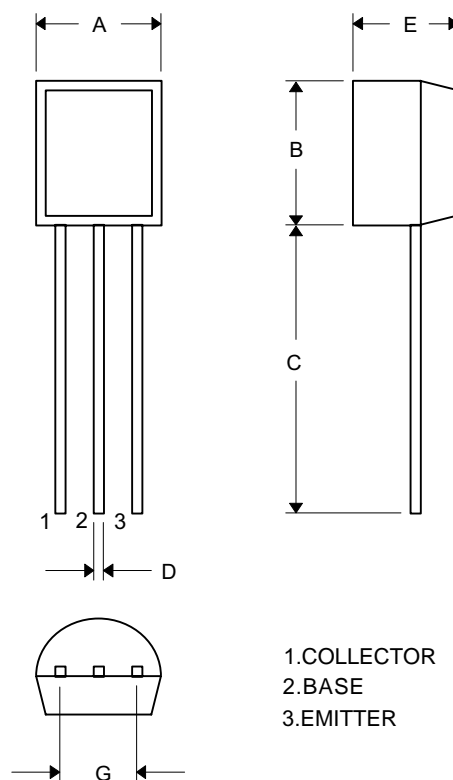

DIMENSIONS

DIM	INCHES		MM		NOTE
	MIN	MAX	MIN	MAX	
A	.170	.190	4.33	4.83	
B	.170	.190	4.30	4.83	
C	.550	.590	13.97	14.97	
D	.010	.020	0.36	0.56	
E	.130	.160	3.30	3.96	
G	.096	.104	2.44	2.64	

Typical Characteristics

BC337

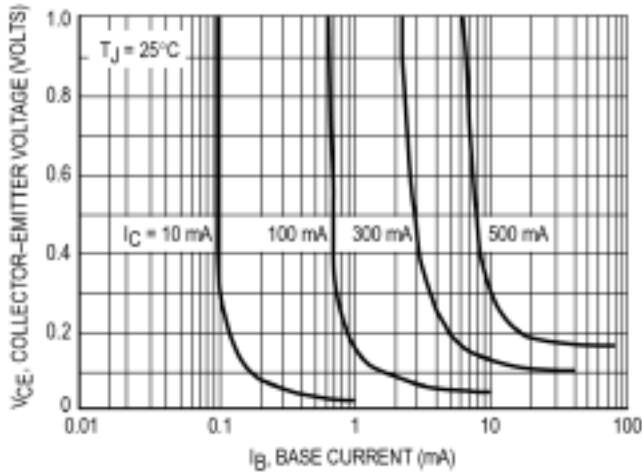

Saturation Region

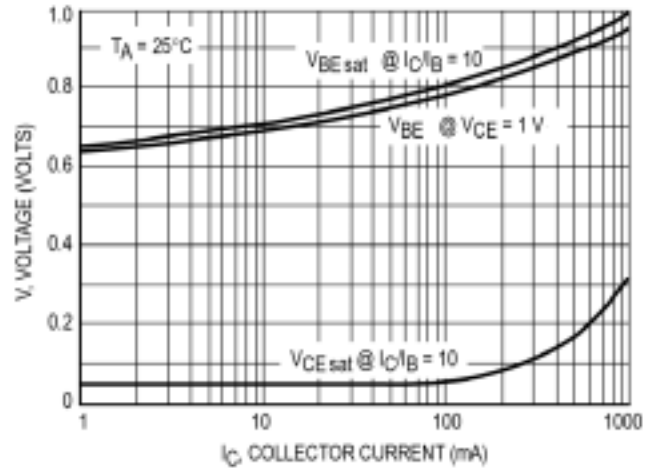

"On" Voltages

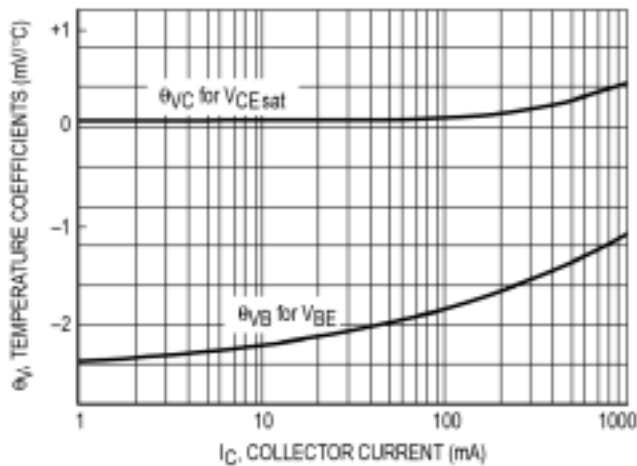

Temperature Coefficients

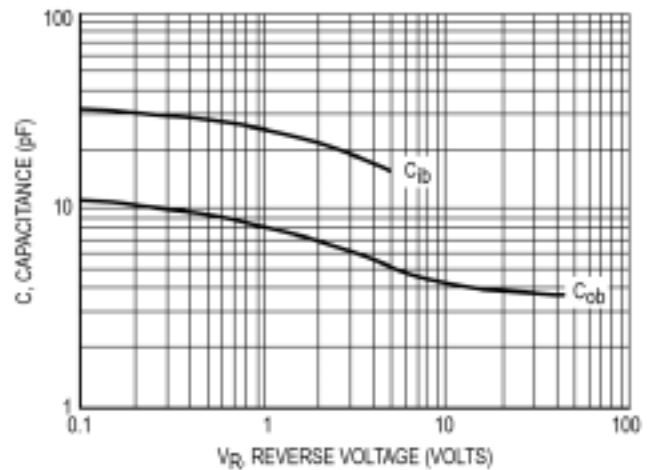

Capacitances

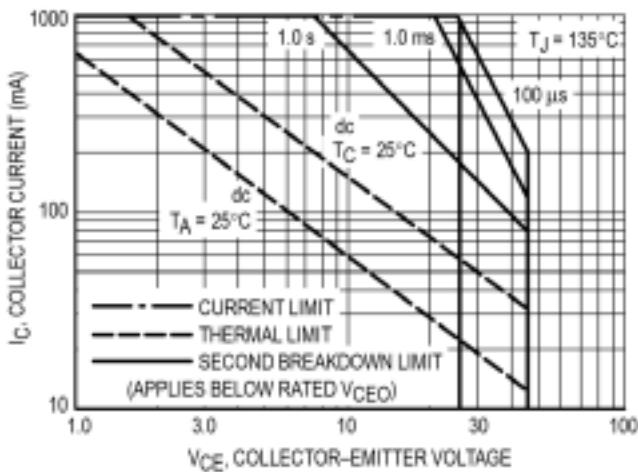

Active Region — Safe Operating Area

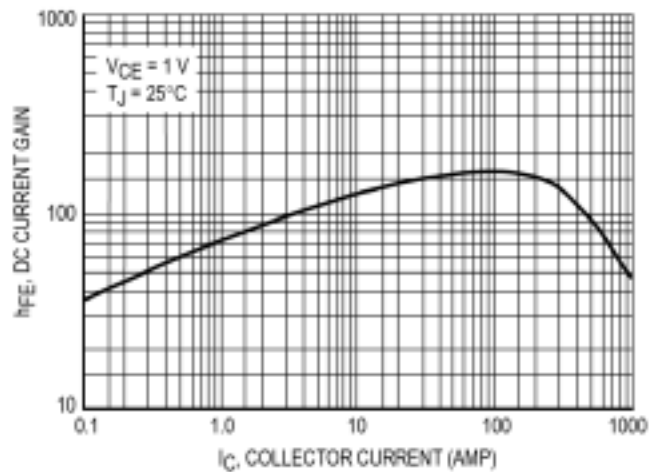

DC Current Gain



TM

Micro Commercial Components

*****IMPORTANT NOTICE*****

Micro Commercial Components Corp. reserves the right to make changes without further notice to any product herein to make corrections, modifications, enhancements, improvements, or other changes. *Micro Commercial Components Corp.* does not assume any liability arising out of the application or use of any product described herein; neither does it convey any license under its patent rights, nor the rights of others. The user of products in such applications shall assume all risks of such use and will agree to hold *Micro Commercial Components Corp.* and all the companies whose products are represented on our website, harmless against all damages.

*****LIFE SUPPORT*****

MCC's products are not authorized for use as critical components in life support devices or systems without the express written approval of Micro Commercial Components Corporation.