

PLEASE CHECK WWW.MOLEX.COM FOR LATEST PART INFORMATION

Part Number: [0039012026](#)
Status: **Active**
Overview: [minifit_jr](#)
Description: 4.20mm (.165") Pitch Mini-Fit Jr.™ Plug Housing, Dual Row, with and without Panel Mount Ears, UL 94V-0, Panel Mount, 2 Circuits

Documents:

[3D Model](#) [Product Specification PS-5556-001 \(PDF\)](#)
[Drawing \(PDF\)](#) [RoHS Certificate of Compliance \(PDF\)](#)

Agency Certification

CSA	LR19980
TUV	R72081037
UL	E29179

General

Product Family	Crimp Housings
Series	5559
Comments	Current = 13A max. per circuit when header is mated to a receptacle loaded with 45750 series terminals crimped to 16 AWG wire. . See Molex product specification PS-45750-001 for additional current de-rating information.. Not for use with Strain Relief
Overview	minifit_jr
Product Name	Mini-Fit Jr.™

Physical

Breakaway	No
Circuits (maximum)	2
Color - Resin	Natural
Flammability	94V-0
Gender	Male
Glow-Wire Compliant	No
Material - Resin	Nylon
Number of Rows	2
Packaging Type	Bag
Panel Mount	Yes
Pitch - Mating Interface (in)	0.165 In
Pitch - Mating Interface (mm)	4.20 mm
Pitch - Term. Interface (in)	0.165 In
Pitch - Term. Interface (mm)	4.20 mm
Polarized to Mating Part	Yes
Stackable	No
Temperature Range - Operating	-40°C to +105°C

Electrical

Current - Maximum per Contact	13A
-------------------------------	-----

Material Info

Old Part Number	5559-02P-210
-----------------	--------------

Reference - Drawing Numbers

Product Specification	PS-5556-001
Sales Drawing	SD-5559-NP



EU RoHS

ELV and RoHS Compliant
REACH SVHC Contains SVHC: No
Halogen-Free Status

China RoHS



Need more information on product environmental compliance?

Email productcompliance@molex.com
 For a multiple part number RoHS Certificate of Compliance, [click here](#)

Please visit the [Contact Us](#) section for any non-product compliance questions.

Search Parts in this Series

[5559Series](#)

Mates With

[5557d Receptacle Housing](#)

Use With

[5558](#) , [44478](#) , [30490](#) , [41995](#)

This document was generated on 05/19/2010

PLEASE CHECK WWW.MOLEX.COM FOR LATEST PART INFORMATION

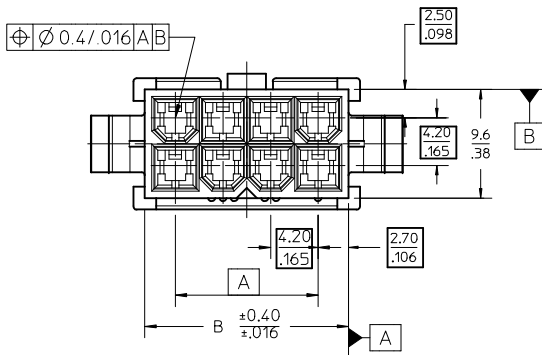
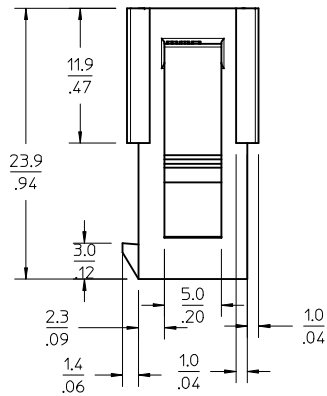
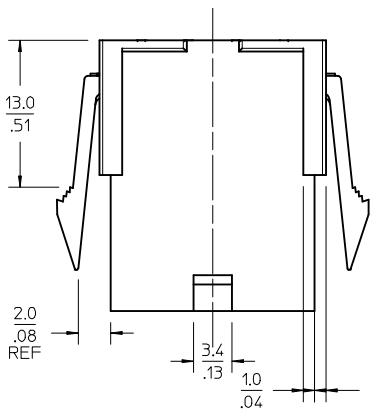
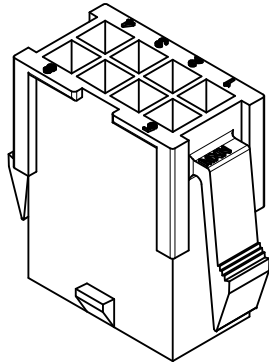
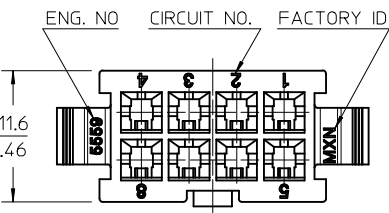

NOTES:

- 1) MATERIAL:
 - *BLANK* = NYLON 6/6, 94V-2, COLOR: NATURAL.
 - *BL* = NYLON 6/6, 94V-2, COLOR: BLACK.
 - *BU* = NYLON 6/6, 94V-2, COLOR: BLUE.
 - *RE* = NYLON 6/6, 94V-2, COLOR: RED.
 - *210* = NYLON 6/6, 94V-0, COLOR: NATURAL.
- 2) FINISH: NOT APPLICABLE
- 3) PRODUCT SPECIFICATION: PS-5556-001
- 4) PACKAGING: BULK
- 5) PART MATES WITH MOLEX RECEPTACLE #5557.
- 6) PART IS TO BE USED WITH MOLEX FEMALE TERMINAL #5558.
- 7) PART IS NOT DESIGNED FOR CURRENT SHARING.
- 8) CONNECTORS ARE NOT TO BE MATED OR UNMATED WHILE CIRCUITS ARE LIVE.
- 9) WIRES ARE TO BE DRESSED IN SUCH A MANNER TO ALLOW THE TERMINALS TO FLOAT FREELY IN THE POCKET.
- 10) PART CONFORMS TO CLASS "B" REQUIREMENTS OF COSMETIC SPECIFICATION PS-45499-002 WITH THE EXCEPTION OF DISCOLORATION, FLASH AND SINK MEET CLASS "C" REQUIREMENTS.
- 11) ON 2 CIRCUITS PARTS THIS DIMENSION IS ALLOWABLE UP TO "D" DIMENSION.
- 12) PANEL HOLE TO BE PUNCHED OUT IN THE SAME DIRECTION AS INSERTION INTO THE PANEL.

LEGEND

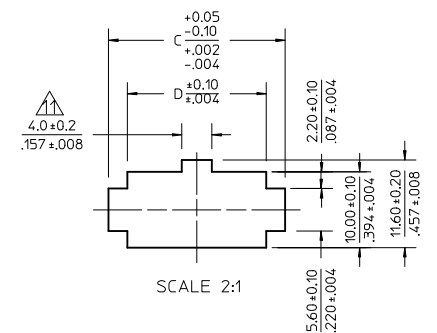
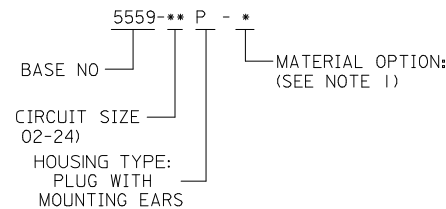

RECOMMENDED PANEL HOLE DIMENSIONS
(THICKNESS : 0.8-2.0/.032-.079)

52.1/2.051	57.0/2.244	51.6/2.031	46.2/1.819	24
47.9/1.886	52.8/2.079	47.4/1.866	42.0/1.654	22
43.7/1.720	48.6/1.913	43.2/1.701	37.8/1.488	20
39.5/1.555	44.4/1.748	39.0/1.535	33.6/1.323	18
35.3/1.390	40.2/1.583	34.8/1.370	29.4/1.158	16
31.1/1.224	36.0/1.417	30.6/1.205	25.2/992	14
26.8/1.055	31.8/1.252	26.4/1.039	21.0/.827	12
22.6/.890	27.6/1.087	22.2/.874	16.8/.661	10
18.4/.724	23.4/.921	18.0/.709	12.6/.496	8
14.2/.559	19.2/.756	13.8/.543	8.4/.331	6
10.0/.394	15.0/.591	9.6/.378	4.2/.165	4
5.8/.228	10.8/.425	5.4/.213	---	2
				CIRCUIT

ADDED MODEL VIEWS EC NO: UCP2010-0850 DRWN: JAGUILAR 2009/11/09 CHKD: J.BELL 2009/11/10 APPR: F.SMITH 2009/11/10	QUALITY SYMBOLS ∇=0 ∇=0 ∇=0	GENERAL TOLERANCES (UNLESS SPECIFIED)	DIMENSION STYLE MM/IN	SCALE 3:1	DESIGN UNITS METRIC	THIRD ANGLE PROJECTION
		4 PLACES ± --- ± --- 3 PLACES ± --- ± .012 2 PLACES ± .30 ± .016 1 PLACE ± .40 ± ---	DRAWN BY H.HIRAMOTO	DATE 1988/10/14	TITLE NEW MINI. FIT CONNECTOR CRIMP PIN HOUSING	
		ANGULAR ± 3 °	CHECKED BY Y. YAMADA	DATE 1988/10/21	APPROVED BY M.ENOMOTO	DATE 1988/10/24
		DRAFT WHERE APPLICABLE MUST REMAIN WITHIN DIMENSIONS	MATERIAL NO. SEE CHART	DOCUMENT NO. SD-5559-NP	SHEET NO. 1 OF 2	

THIS DRAWING CONTAINS INFORMATION THAT IS PROPRIETARY TO MOLEX INCORPORATED AND SHOULD NOT BE USED WITHOUT WRITTEN PERMISSION

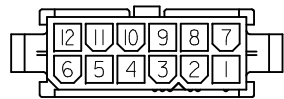

12CKTS.

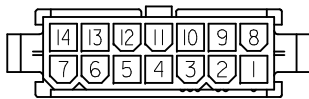

14CKTS.

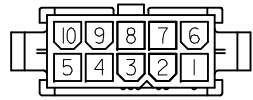

14CKTS.

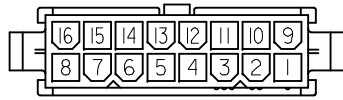

16CKTS.

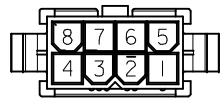

8CKTS.

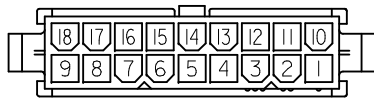

18CKTS.

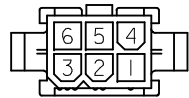

6CKTS.

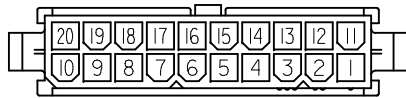

20CKTS.

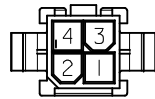

4CKTS.

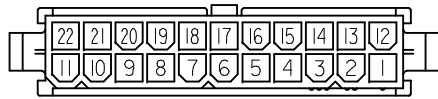

22CKTS.

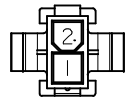

2CKTS.

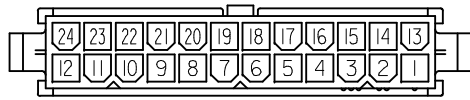

24CKTS.

CIRCUIT SIZE LAYOUT (SCALE : 2-1)

V-2 BLACK		
EDP NO.	ENG. NO.	CIRCUIT
		24
		22
		20
		18
		16
		14
		12
		10
		8
39-02-8065	5569-06P-BL	6
39-02-8045	5569-04P-BL	4
		2

V-2 BLUE			V-2 RED			V-0 NATURAL			V-2 NATURAL		
EDP NO.	ENG. NO.	CIRCUIT	EDP NO.	ENG. NO.	CIRCUIT	EDP NO.	ENG. NO.	CIRCUIT	EDP NO.	ENG. NO.	CIRCUIT
		24			24	39-01-2246	5559-24P-210	24	39-01-2241	5559-24P	24
		22			22	↑ -2226	↑ -22P-210	22	↑ -2221	↑ -22P	22
		20			20	↑ -2206	↑ -20P-210	20	↑ -2201	↑ -20P	20
		18			18	↑ -2186	↑ -18P-210	18	↑ -2181	↑ -18P	18
		16			16	↑ -2166	↑ -16P-210	16	↑ -2161	↑ -16P	16
		14			14	↑ -2146	↑ -14P-210	14	↑ -2141	↑ -14P	14
		12			12	↑ -2126	↑ -12P-210	12	↑ -2121	↑ -12P	12
		10			10	↑ -2106	↑ -10P-210	10	↑ -2101	↑ -10P	10
		8			8	↑ -2086	↑ -08P-210	8	↑ -2081	↑ -08P	8
		6	39-02-8067	5559-06P-RE	6	↑ -2066	↑ -06P-210	6	↑ -2061	↑ -06P	6
39-02-8046	5569-04P-BU	4	39-02-8047	5559-04P-RE	4	↓ -2046	↓ -04P-210	4	↓ -2041	↓ -04P	4
		2			2	39-01-2026	5559-02P-210	2	39-01-2021	5559-02P	2

SEE SHEET 1 EC NO: UCP2010-0850 DRWN: JAGUILAR 2009/11/09 CHKD: BELL 2009/11/10 APPR: FSMITH 2009/11/10	DESCRIPTION QUALITY SYMBOLS ▽=0 ▽=0 ▽=0	GENERAL TOLERANCES (UNLESS SPECIFIED)		DIMENSION STYLE MM/IN		SCALE 2:1		DESIGN UNITS <input checked="" type="checkbox"/> METRIC		<input checked="" type="checkbox"/> THIRD ANGLE PROJECTION		
		4 PLACES ± --- ± --- 3 PLACES ± --- ± .012 2 PLACES ± .30 ± .016 1 PLACE ± .40 ± ---		DRAWN BY H. HIRAMOTO		DATE 1988/10/14		NEW MINI. FIT CONNECTOR CRIMP PIN HOUSING		MOLEX INCORPORATED		SHEET NO. 2 OF 2
		ANGULAR ± 3°		CHECKED BY Y. YAMADA		DATE 1988/10/21						
		DRAFT WHERE APPLICABLE MUST REMAIN WITHIN DIMENSIONS		APPROVED BY M. ENOMOTO		DATE 1988/10/24		MATERIAL NO. SEE CHART		DOCUMENT NO. SD-5559-NP		

THIS DRAWING CONTAINS INFORMATION THAT IS PROPRIETARY TO MOLEX INCORPORATED AND SHOULD NOT BE USED WITHOUT WRITTEN PERMISSION