

POWER TRANSISTOR E13002

SWITCHING REGULATOR APPLICATION

- High speed switching
- Suitable for switching regulator and motor control
- Case : TO-126 molded plastic body

TO-126

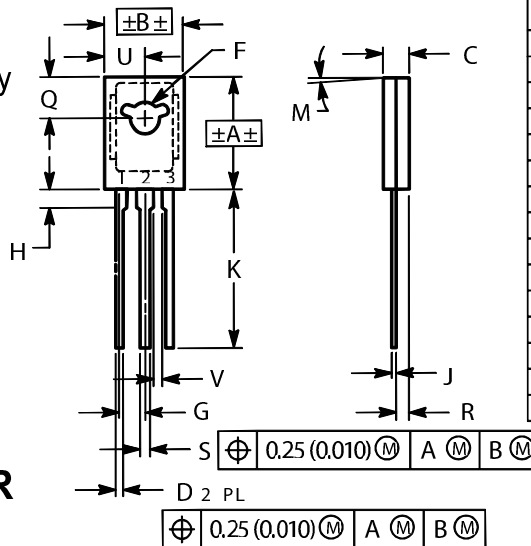

DIM	INCHES		MILLIMETERS	
	MIN	MAX	MIN	MAX
A	0.425	0.435	10.80	11.04
B	0.295	0.305	7.50	7.74
C	0.095	0.105	2.42	2.66
D	0.020	0.026	0.51	0.66
F	0.115	0.130	2.93	3.30
G	0.094 BSC		2.39 BSC	
H	0.050	0.095	1.27	2.41
J	0.015	0.025	0.39	0.63
K	0.575	0.655	14.61	16.63
M	5 TYP		5 TYP	
Q	0.148	0.158	3.76	4.01
R	0.045	0.065	1.15	1.65
S	0.025	0.035	0.64	0.88
U	0.145	0.155	3.69	3.93
V	0.040	±±±	1.02	±±±

NPN SILICON TRANSISTOR

FEATURES $T_c=25^\circ\text{C}$ unless otherwise specified

Parameter	Symbol	Value	UNIT
Power dissipation	P_{CM}	1.2	W
Collector current	I_{CM}	1.0	A
Operating and storage junction temperature range	T_J, T_{STG}	-55°C to $+150^\circ\text{C}$	$^\circ\text{C}$

ELECTRICAL CHARACTERISTICS $T_c=25^\circ\text{C}$ unless otherwise specified

Parameter	Symbol	Test conditions	MIN	MAX	UNIT
Collector-base breakdown voltage	$V_{(BR)CBO}$	$I_C=100\mu\text{A}, I_E=0$	600		V
Collector-emitter breakdown voltage	$V_{(BR)CEO}$	$I_C=1\text{mA}, I_B=0$	400		V
Emitter-base breakdown voltage	$V_{(BR)EBO}$	$I_E=100\mu\text{A}, I_C=0$	6		V
Collector cut-off current	I_{CBO}	$V_{CB}=600\text{V}, I_E=0$		100	μA
Emitter cut-off current	I_{EBO}	$V_{EB}=6\text{V}, I_C=0$		100	μA
DC current gain	$h_{FE(1)}$	$V_{CE}=10\text{V}, I_C=100\text{mA}$	8	60	
	$h_{FE(2)}$	$V_{CE}=10\text{V}, I_C=200\text{mA}$	9	40	
	$h_{FE(3)}$	$V_{CE}=10\text{V}, I_C=10\text{mA}$	6		
Collector-emitter saturation voltage	V_{CEsat}	$I_C=200\text{mA}, I_B=40\text{mA}$		0.8	V
Base-emitter saturation voltage	V_{BEsat}	$I_C=200\text{mA}, I_B=40\text{mA}$		1.1	V
Transition frequency	f_T	$V_{CE}=10\text{V}, I_C=100\text{mA}$ $f=1\text{MHz}$	5		MHz
Fall time	t_f	$I_C=1\text{A}, I_{B1}=-I_{B2}=0.2\text{A}$		0.5	μs
Storage time	t_s	$V_{CC}=100\text{V}$			μs

RATINGS AND CHARACTERISTIC CURVES E13002

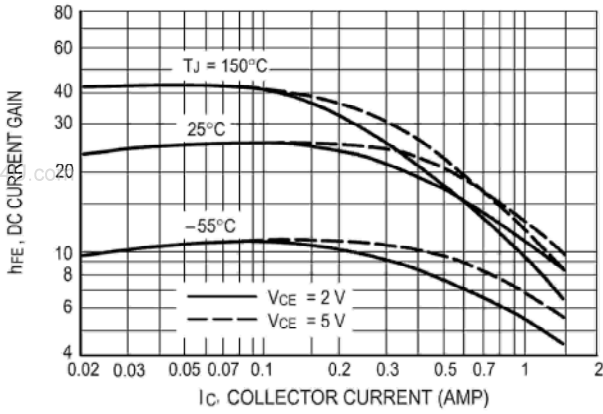

DC Current Gain

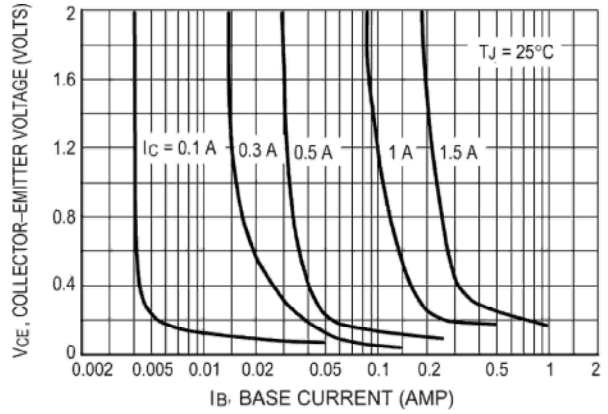

Collector Saturation Region

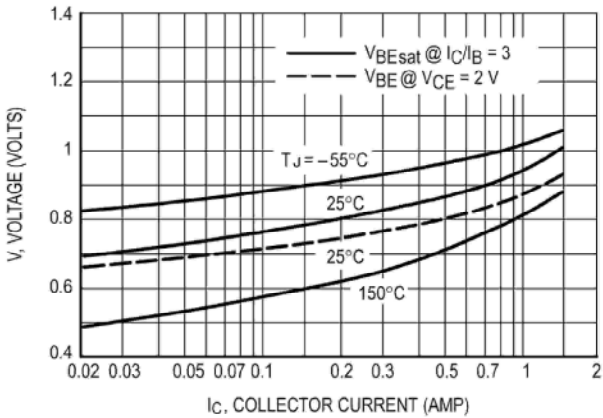

Base-Emitter Voltage

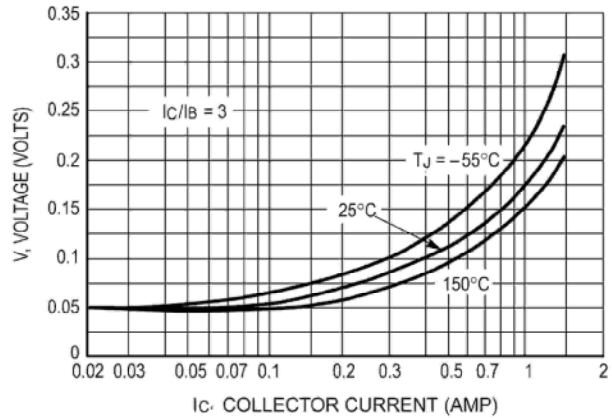

Collector-Emitter Saturation Region

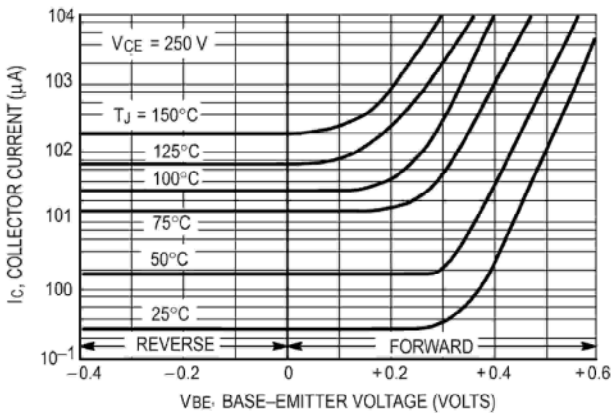

Collector Cutoff Region

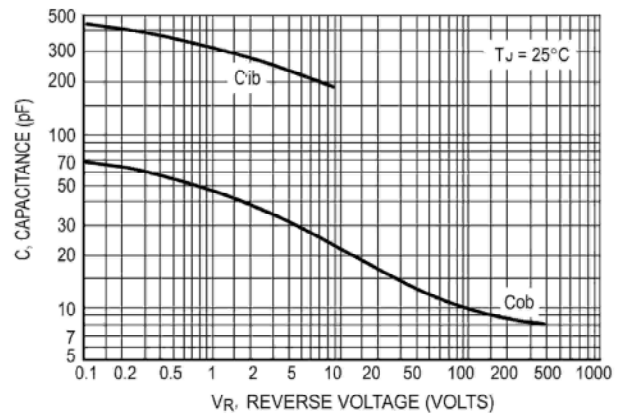

Capacitance