

1. PART NO. EXPRESSION :

C 3 - 1 N 0 S - 1 0

(a) (b) (c) (d)

(a) Series code

(b) Inductance code : 1N0 = 1.0nH

(c) Tolerance code : S = $\pm 0.3\text{nH}$, J = $\pm 5\%$

(d) 10 : RoHS Compliant

2. CONFIGURATION & DIMENSIONS :

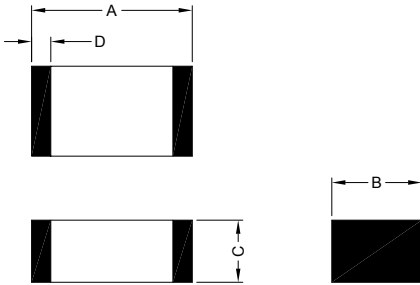

Unit:m/m

A	B	C		D
2.0 \pm 0.2	1.25 \pm 0.2	0.85 \pm 0.2	1.25 \pm 0.2	0.2 ~ 0.8

3. GENERAL SPECIFICATION :

- a) Operating temp. : -40°C to +85°C
- b) Storage temp. : -10°C to +40°C
- c) Humidity range : 70% RH Max.
- d) Resistance to solder heat : 265°C.6secs



RoHS Compliant

NOTE : Specifications subject to change without notice. Please check our website for latest information.

04.06.2009



SUPERWORLD ELECTRONICS (S) PTE LTD

4. ELECTRICAL CHARACTERISTICS :

Part Number	Dim. C ±0.2	Inductance (nH)	Q Min.	Test Frequency (MHz)	SRF (GHz) Min.	DCR (Ω) Max.	Rated Current (mA) Max.
C3-1N0S-10	0.85	1.0	10	100	10	0.10	300
C3-1N2S-10	0.85	1.2	10	100	10	0.10	300
C3-1N5S-10	0.85	1.5	10	100	4.0	0.10	300
C3-1N8S-10	0603	1.8	10	100	4.0	0.10	300
C3-2N2S-10	0603	2.2	10	100	4.0	0.10	300
C3-2N7S-10	0.85	2.7	12	100	4.0	0.10	300
C3-3N3S-10	0.85	3.3	12	100	4.0	0.13	300
C3-3N9S-10	0.85	3.9	12	100	4.0	0.15	300
C3-4N7S-10	0.85	4.7	12	100	3.5	0.20	300
C3-5N6S-10	0.85	5.6	15	100	3.2	0.23	300
C3-6N8J-10	0.85	6.8	15	100	2.8	0.25	300
C3-8N2J-10	0.85	8.2	15	100	2.4	0.28	300
C3-10NJ-10	0.85	10	15	100	2.1	0.30	300
C3-12NJ-10	0.85	12	15	100	1.9	0.35	300
C3-15NJ-10	0.85	15	15	100	1.6	0.40	300
C3-18NJ-10	0.85	18	15	100	1.5	0.45	300
C3-22NJ-10	0.85	22	18	100	1.4	0.50	300
C3-27NJ-10	0.85	27	18	100	1.3	0.55	300
C3-33NJ-10	0.85	33	18	100	1.2	0.60	300
C3-39NJ-10	0.85	39	18	100	1.0	0.65	300
C3-47NJ-10	0.85	47	18	100	0.9	0.70	300
C3-56NJ-10	0.85	56	18	100	0.8	0.75	300
C3-68NJ-10	0.85	68	18	100	0.7	0.80	300
C3-82NJ-10	0.85	82	18	100	0.6	0.90	300
C3-R10J-10	0.85	100	18	100	0.6	0.90	300
C3-R12J-10	0.85	120	13	50	0.5	0.95	300
C3-R15J-10	1.25	150	13	50	0.5	1.00	300
C3-R18J-10	1.25	180	13	50	0.4	1.10	300
C3-R22J-10	1.25	220	12	50	0.35	1.20	300
C3-R27J-10	1.25	270	12	50	0.3	1.30	300
C3-R33J-10	1.25	330	12	50	0.25	1.40	300
C3-R39J-10	1.25	390	10	50	0.25	1.40	300
C3-R47J-10	1.25	470	10	50	0.20	1.50	300
C3-R56J-10	1.25	560	10	25	0.18	5.00	50
C3-R68J-10	1.25	680	10	25	0.16	5.50	50

Tolerance code :

S : ±0.3nH

J : ±5%

NOTE : Specifications subject to change without notice. Please check our website for latest information.

04.06.2009



SUPERWORLD ELECTRONICS (S) PTE LTD

5. CHARACTERISTICS CURVES :

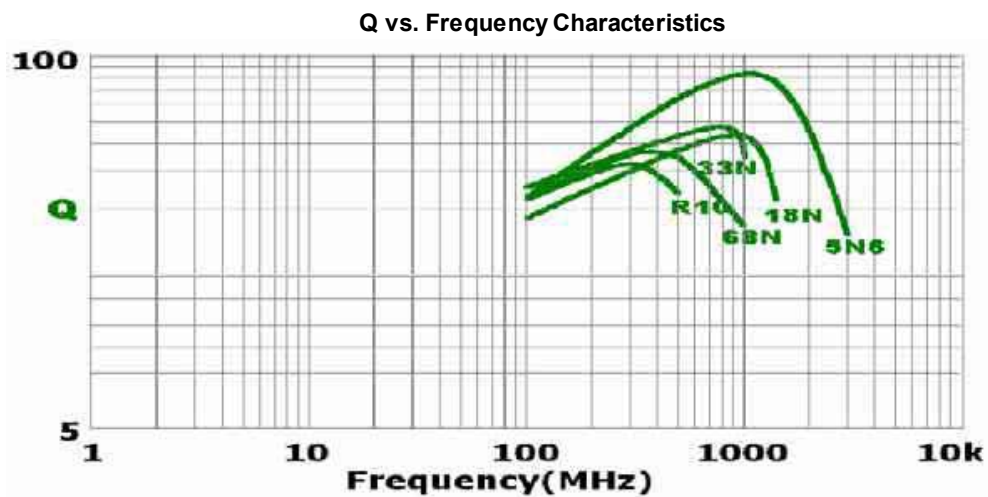
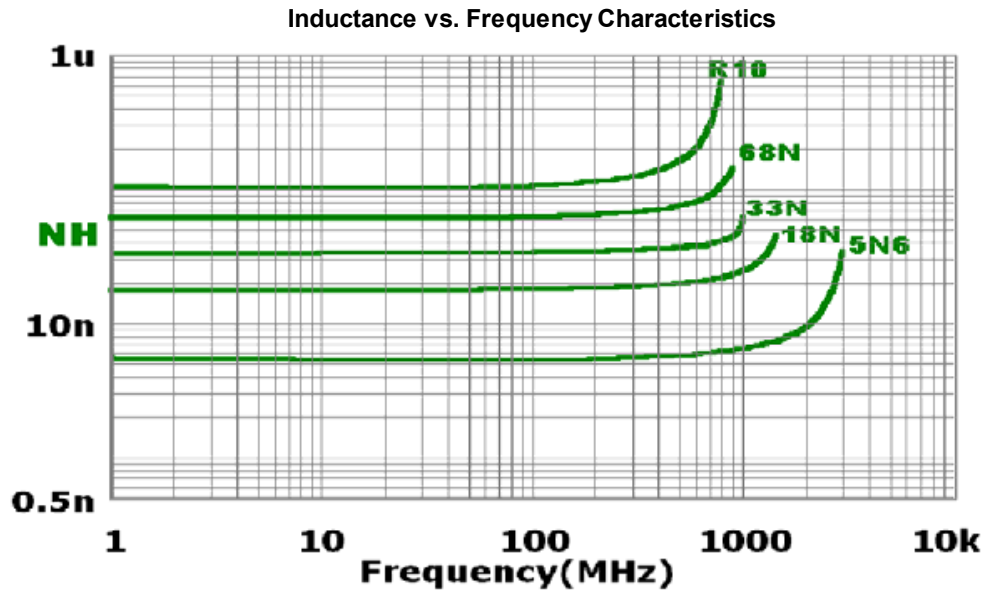

RoHS Compliant

NOTE : Specifications subject to change without notice. Please check our website for latest information.

04.06.2009



SUPERWORLD ELECTRONICS (S) PTE LTD

6. RELIABILITY & TEST CONDITION :

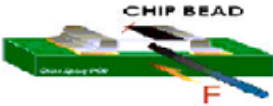
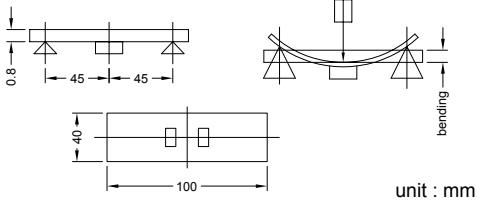
ITEM	PERFORMANCE	TEST CONDITION
DC Resistance		HP4338 digital milli-ohm meter
Terminal Strength	Appearance : No significant abnormality Impedance change : Within $\pm 30\%$ DCR : Shall be satisfied	Solder chip on PCB and applied 10N (1.02KgF) for 10sec 
Substrate Bending Strength	Appearance : No significant abnormality Inductance change : Within $\pm 20\%$ DCR : Shall be satisfied	Solder a chip on a test substrate, bend the substrate by 3mm hold for 10s and then return. Soldering shall be done in accordance with the recommended PC board pattern and reflow soldering  unit : mm
Resistance to Solder Heat	Appearance : No significant abnormality Electrical and mechanical characteristics shall be satisfied Consult standard MIL-STD-202 METHOD 210	Preheat : 100 ~ 150°C, 60sec. Solder : Sn-Ag3.0-Cu0.5 Solder Temperature : 265 \pm 3°C Dip Time : 6 \pm 1sec. Measurement to be made after keeping at room temp for 24 \pm 2hrs
Solderability	More than 95% coverage of all metallized area Consult standard J-STD-002	Solder Temperature : 240 \pm 5°C Solder : Sn-Ag3.0-Cu0.5 Dip Time : 3 \pm 1sec.
High Temperature Resistance	Appearance : No mechanical damage. Inductance : Within $\pm 20\%$ of initial value.	Temperature : 85 \pm 2°C Applied Current : rated current (max. value) Duration : 1008 \pm 12hrs Measurement : After placing for 24 hours (min.) at room ambient temperature
Humidity Resistance	Appearance : No mechanical damage. Inductance : Within $\pm 20\%$ of initial value.	Humidity : 90~95% RH. Temperature : 60 \pm 2°C Applied Current : rated current (max. value) Duration : 1008 \pm 12hrs Measurement : After placing for 24 hours (min.) at room ambient temperature
Temperature Cycle	Appearance : No mechanical damage. Inductance : Within $\pm 20\%$ of initial value.	Condition for 1 cycle Step1 : -40 \pm 3°C 30 \pm 3 min. Step2 : Room temperature 2 to 5 minutes Step3 : +85 \pm 2°C 30 \pm 3 min. Step4 : Room temperature 2 to 5 minutes Number of cycles : 100 Measurement : After placing for 24 hours (min.) at room ambient temperature



RoHS Compliant

NOTE : Specifications subject to change without notice. Please check our website for latest information.

04.06.2009



SUPERWORLD ELECTRONICS (S) PTE LTD

6. RELIABILITY & TEST CONDITION :

ITEM	PERFORMANCE	TEST CONDITION
Low Temperature Storage test	Appearance : No mechanical damage. Inductance : Within $\pm 20\%$ of initial value.	Temperature : $-40\pm 2^{\circ}\text{C}$ Duration : 1008 ± 12 hrs Measurement : After placing for 24 hours (min.) at room ambient temperature
Thermal Shock	Appearance : No mechanical damage. Inductance : Within $\pm 20\%$ of initial value.	Temperature : -40°C , $+85^{\circ}\text{C}$ kept stabilized for 30 minutes each Cycle : 100 cycles Measurement : After placing for 24 hours (min.) at room ambient temperature
Vibration Test	Appearance : No mechanical damage. Inductance : Within $\pm 20\%$ of initial value.	Waveform : Sine wave Frequency : 10-55-10Hz for 1 min. Amplitude : 1.5mm(peak-peak) Directions & times : X, Y, Z directions for 2 hours. A period of 2 hours in each of 3 mutually perpendicular directions (Total 6 hours).



RoHS Compliant

NOTE : Specifications subject to change without notice. Please check our website for latest information.

04.06.2009



SUPERWORLD ELECTRONICS (S) PTE LTD

PG. 5

7. SOLDERING :

7-1. Reflow soldering conditions

Pre-heating should be in such a way that the temperature difference between solder and ferrite surface is limited to 150°C max. Also cooling into the solvent after soldering should be in such a way that the temperature difference is limited to 100°C max. Insufficient pre-heating may cause cracks on the ferrite, resulting in the deterioration of product quality.

Products should be soldered within the following allowable range indicated by the slanted line. The excessive soldering conditions may cause the corrosion of the electrode. When soldering is repeated, allowable time is the accumulated time.

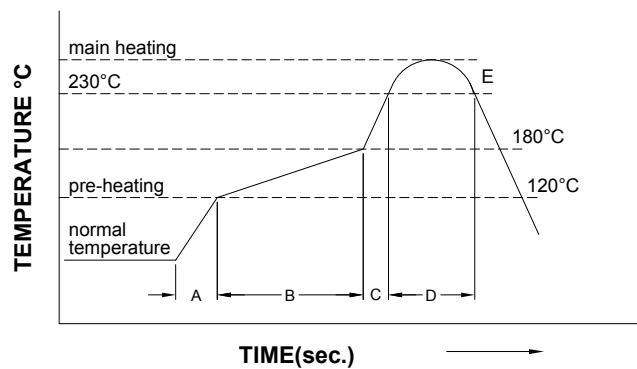
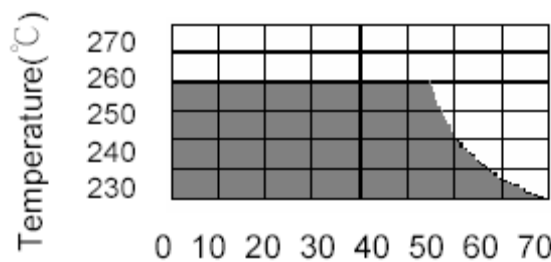

A	Slope of temp. rise	1 to 5	°C/sec
B	Heat time	50 to 150	sec
	Heat temperature	120 to 180	°C
C	Slope of temp. rise	1 to 5	°C/sec
D	Time over 230°C	90 ~ 120	sec
E	Peak temperature	255 ~ 260	°C
	Peak hold time	10 max.	sec
No. of mounting		3	times

(Melting area of solder)

7-2. Soldering Iron

Products attachment with soldering iron is discouraged due to the inherent process control limitations. In the event that a soldering iron must be employed the following precautions are recommended.

Note :

- a) Preheat circuit and products to 150°C.
- b) 280°C tip temperature (max)
- c) Never contact the ceramic with the iron tip
- d) 3.0mm tip diameter (max)
- e) Use a 30 watt max. soldering iron with tip diameter of 3.0mm
- f) Limit soldering time to 3 secs.

7-3. Solder Volume :

Accordingly increasing the solder volume, the mechanical stress to product is also increased. Exceeding solder volume may cause the failure of mechanical or electrical performance. Solder shall be used not to be exceed as shown in right side.

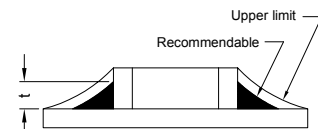

RoHS Compliant

NOTE : Specifications subject to change without notice. Please check our website for latest information.

04.06.2009



SUPERWORLD ELECTRONICS (S) PTE LTD

8. PACKAGING INFORMATION :

8-1. Paper Carrier Tape Packaging

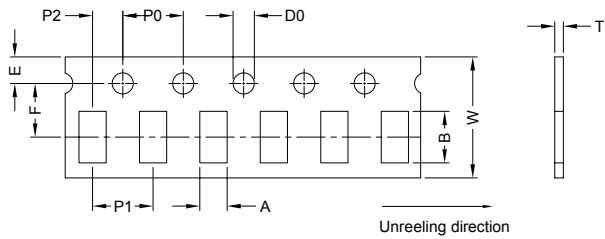

A(mm)	B(mm)	W(mm)	F(mm)	E(mm)	P1(mm)	P2(mm)	P0(mm)	D0(mm)	t(mm)
1.45±0.05	2.25±0.05	8.00±0.10	3.50±0.05	1.75±0.10	4.00±0.10	2.00±0.05	4.00±0.10	1.55±0.05	0.95±0.05

8-2. Leader And Trailer Tape

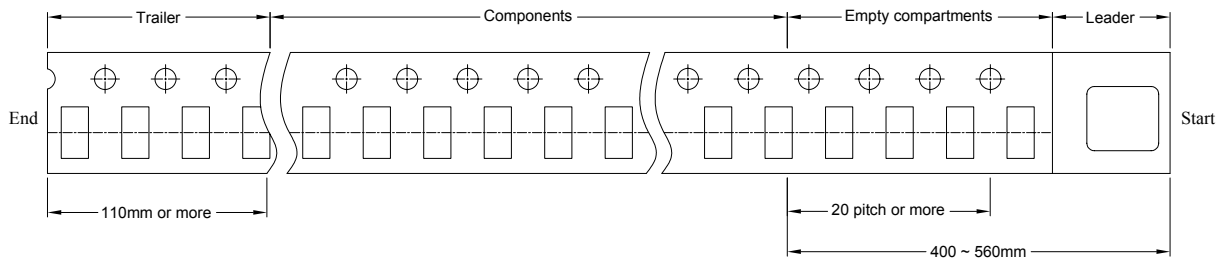

8-3. Configuration

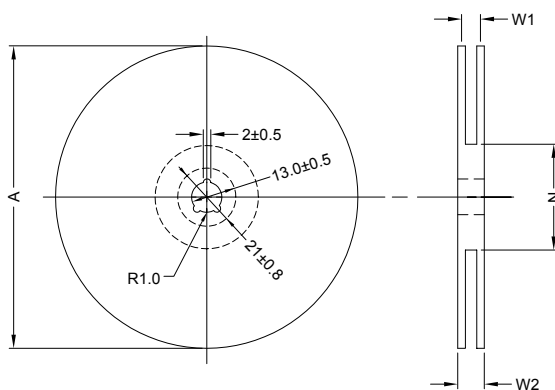

A(mm)	N(mm)	W1(mm)	W2(mm)	QTY (PCS)
178±2.0	50 Min.	10±1.5	20 Max.	4000/Reel



RoHS Compliant

NOTE : Specifications subject to change without notice. Please check our website for latest information.

04.06.2009



SUPERWORLD ELECTRONICS (S) PTE LTD

PG. 7

8-4. Tearing Off Force

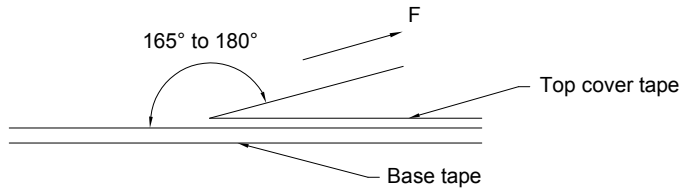

Peeling Strength of Cover Tape

Cover Tape	10g ~ 100g
------------	------------

Peel Speed : 300mm/min

8-5. Packaging

1. Reel and a bag of desiccant shall be packed in Nylon or plastic bag
2. Maximum of 5 bags shall be packed in an inner box
3. Maximum of 6 inner boxes shall be packed in an outer box

Application Notice

1. Storage Conditions :

To maintain the solderability of terminal electrodes :

- a) Temperature and humidity conditions : Less than 40°C and 70% RH.
- b) Recommended products should be used within 6 months from the time of delivery.
- c) The packaging material should be kept where no chlorine or sulfur exists in the air.

2. Transportation :

- a) Products should be handled with care to avoid damage or contamination from perspiration and skin oils.
- b) The use of tweezers or vacuum pick up is strongly recommended for individual components.
- c) Bulk handling should ensure that abrasion and mechanical shock are minimized.



RoHS Compliant

NOTE : Specifications subject to change without notice. Please check our website for latest information.

04.06.2009



SUPERWORLD ELECTRONICS (S) PTE LTD