

International  
**IR** Rectifier

**QUIETIR** Series  
**20ETF..FP**

**FAST SOFT RECOVERY  
RECTIFIER DIODE  
TO-220 FULLPAK**

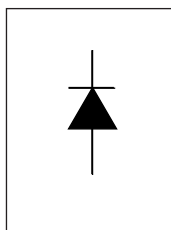

$$V_F < 1.2V @ 10A$$

$$I_{FSM} = 300A$$

$$V_{RRM} 200 \text{ to } 600V$$

**Description/Features**

The 20ETF.. FP soft recovery **QUIETIR** rectifier series has been optimized for combined short reverse recovery time and low forward voltage drop.

The glass passivation ensures stable reliable operation in the most severe temperature and power cycling conditions.

Typical applications are:

- output rectification and freewheeling in inverters, choppers and converters
- and input rectifications where severe restrictions on conducted EMI should be met
- fully isolated package ( $V_{INS} = 2500 V_{RMS}$ )

UL E78996 approved 

**Major Ratings and Characteristics**

Characteristics	20ETF..FP	Units
$I_{F(AV)}$ Sinusoidal waveform	20	A
$V_{RRM}$	200 to 600	V
$I_{FSM}$	300	A
$V_F$ @ 10A, $T_J = 25^\circ C$	1.2	V
$t_{rr}$ @ 1A, 100A/ $\mu s$	60	ns
$T_J$	-40 to 150	$^\circ C$

**Package Outline**

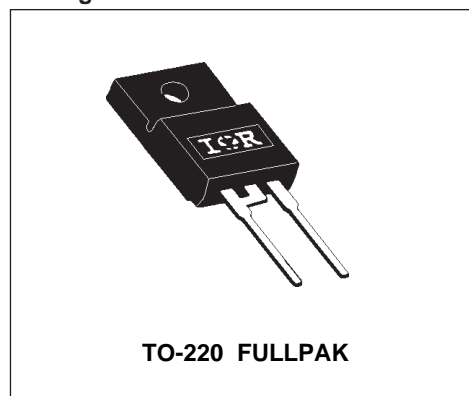

Voltage Ratings

Part Number	$V_{RRM}$ , maximum peak reverse voltage V	$V_{RSM}$ , maximum non repetitive peak reverse voltage V	$I_{RRM}$ 150°C mA
20ETF02FP	200	300	5
20ETF04FP	400	500	
20ETF06FP	600	700	

Absolute Maximum Ratings

Parameters	20ETF..FP	Units	Conditions
$I_{F(AV)}$ Max. Average Forward Current	20	A	@ $T_C = 94^\circ\text{C}$ , 180° conduction half sine wave
$I_{FSM}$ Max. Peak One Cycle Non-Repetitive Surge Current	250	A	10ms Sine pulse, rated $V_{RRM}$ applied
	300		10ms Sine pulse, no voltage reapplied
$I^2t$ Max. $I^2t$ for fusing	316	$A^2s$	10ms Sine pulse, rated $V_{RRM}$ applied
	442		10ms Sine pulse, no voltage reapplied
$I^2\sqrt{t}$ Max. $I^2\sqrt{t}$ for fusing	4420	$A^2\sqrt{s}$	$t = 0.1$ to 10ms, no voltage reapplied

Electrical Specifications

Parameters	20ETF..FP	Units	Conditions
$V_{FM}$ Max. Forward Voltage Drop	1.30	V	@ 20A, $T_J = 25^\circ\text{C}$
	1.67	V	@ 60A, $T_J = 25^\circ\text{C}$
$r_t$ Forward slope resistance	12.5	$m\Omega$	
$V_{F(TO)}$ Threshold voltage	0.9	V	$T_J = 150^\circ\text{C}$
$I_{RM}$ Max. Reverse Leakage Current	0.1	mA	$T_J = 25^\circ\text{C}$
	5.0	mA	$T_J = 150^\circ\text{C}$

$V_R = \text{rated } V_{RRM}$

Recovery Characteristics

Parameters	20ETF..FP	Units	Conditions
$t_{rr}$ Reverse Recovery Time	160	ns	$I_F @ 20\text{Apk}$ @ 100A/ $\mu\text{s}$ @ 25°C
$I_{rr}$ Reverse Recovery Current	10	A	
$Q_{rr}$ Reverse Recovery Charge	1.25	$\mu\text{C}$	
S Snap Factor $t_b/t_a$	0.6	typical	

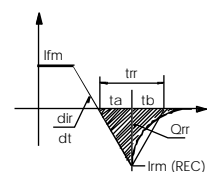

Thermal-Mechanical Specifications

Parameters	20ETF..FP	Units	Conditions
T <sub>J</sub> Max. Junction Temperature Range	-40 to 150	°C	
T <sub>stg</sub> Max. Storage Temperature Range	-40 to 150	°C	
R <sub>thJC</sub> Max. Thermal Resistance Junction to Case	1.5	°C/W	DC operation
R <sub>thJA</sub> Max. Thermal Resistance Junction to Ambient	62	°C/W	
R <sub>thCS</sub> Typical Thermal Resistance Case to Heatsink	1.5	°C/W	Mounting surface, smooth and greased
wt Approximate Weight	2(0.07)	g(oz.)	
T Mounting Torque	Min.	6(5)	Kg-cm (lbf-in)
	Max.	12(10)	
Case Style	TO-220FULLPAK		

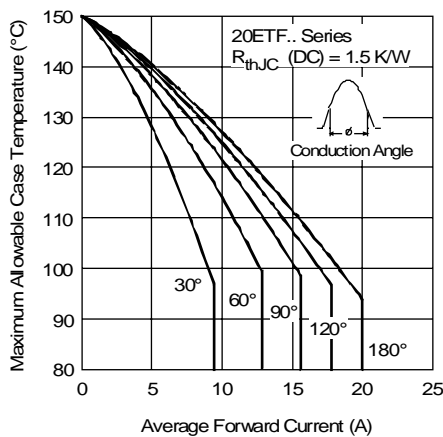

Fig. 1 - Current Rating Characteristics

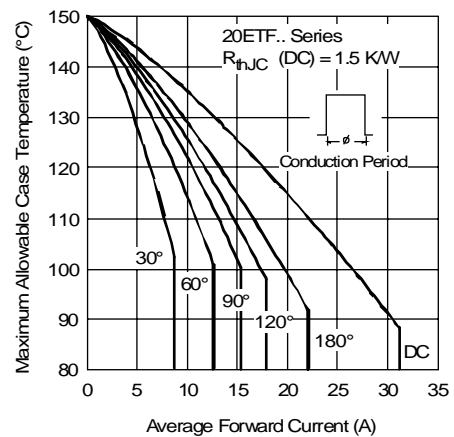

Fig. 2 - Current Rating Characteristics

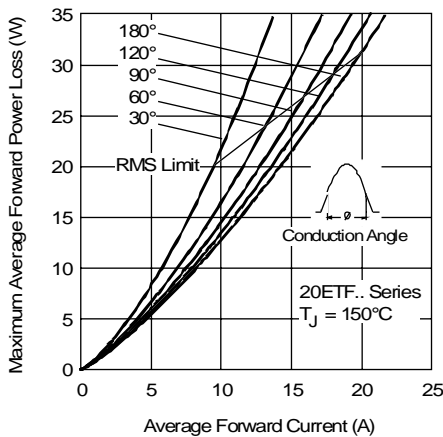

Fig. 3 - Forward Power Loss Characteristics

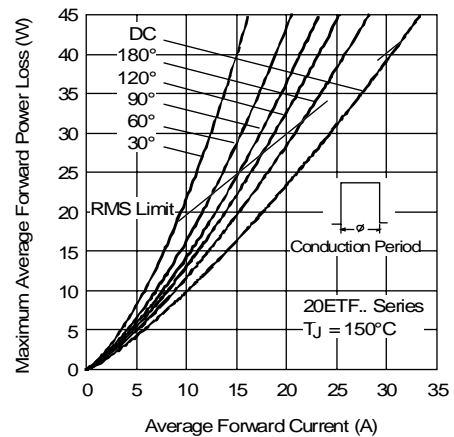

Fig. 4 - Forward Power Loss Characteristics

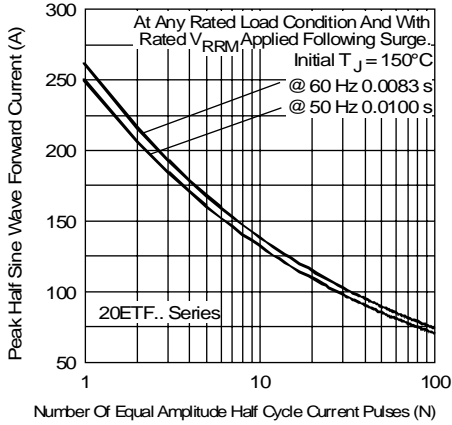

Fig. 5 - Maximum Non-Repetitive Surge Current

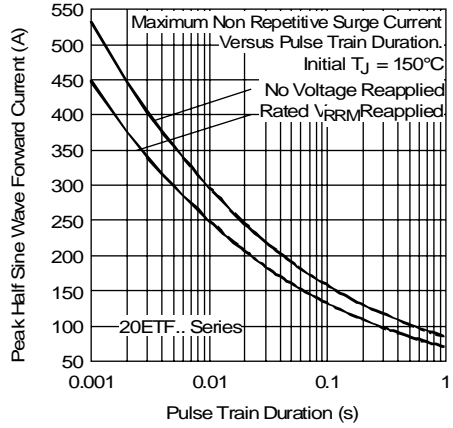

Fig. 6 - Maximum Non-Repetitive Surge Current

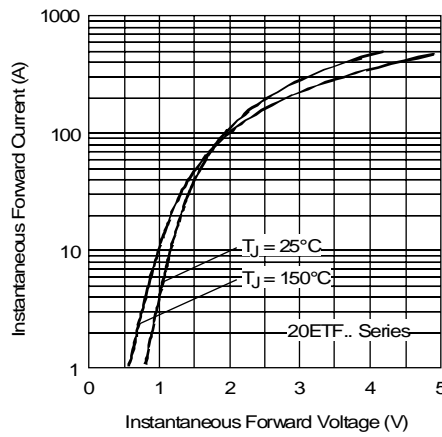

Fig. 7 - Forward Voltage Drop Characteristics

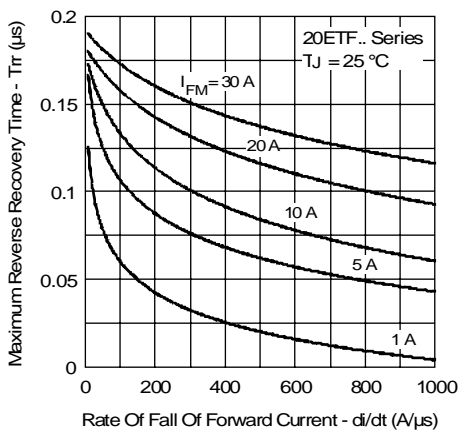

Fig. 8 - Recovery Time Characteristics,  $T_J = 25^\circ\text{C}$

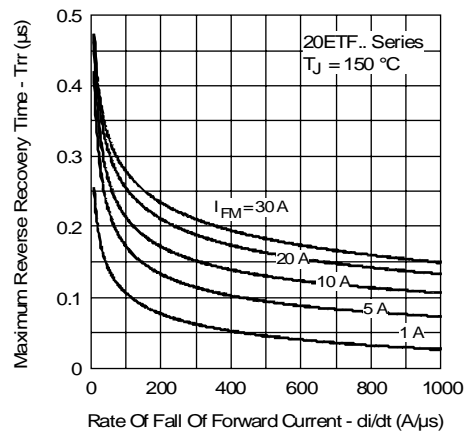

Fig. 9 - Recovery Time Characteristics,  $T_J = 150^\circ\text{C}$

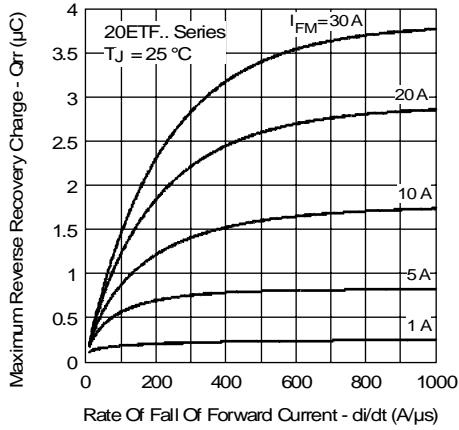

Fig. 10 - Recovery Charge Characteristics,  $T_J = 25^\circ\text{C}$

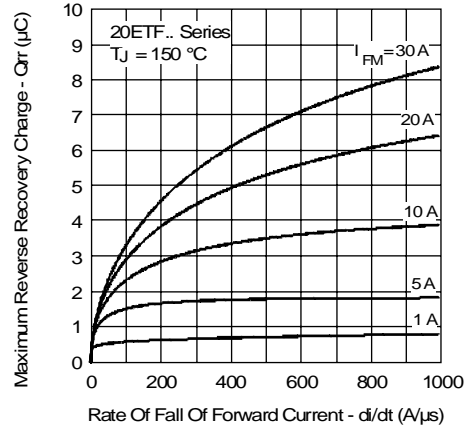

Fig. 11 - Recovery Charge Characteristics,  $T_J = 150^\circ\text{C}$

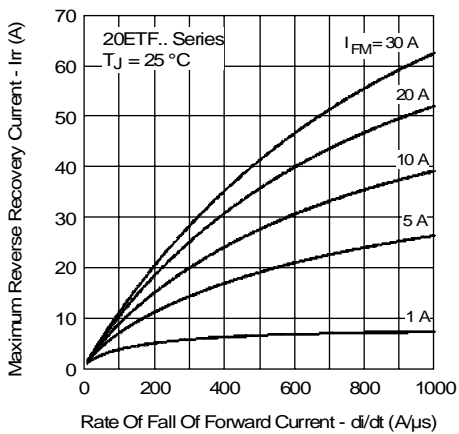

Fig. 12 - Recovery Current Characteristics,  $T_J = 25^\circ\text{C}$

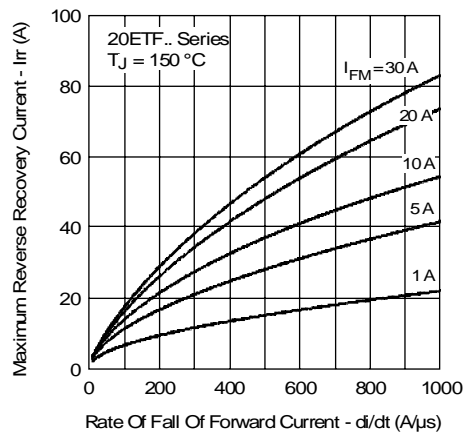

Fig. 13 - Recovery Current Characteristics,  $T_J = 150^\circ\text{C}$

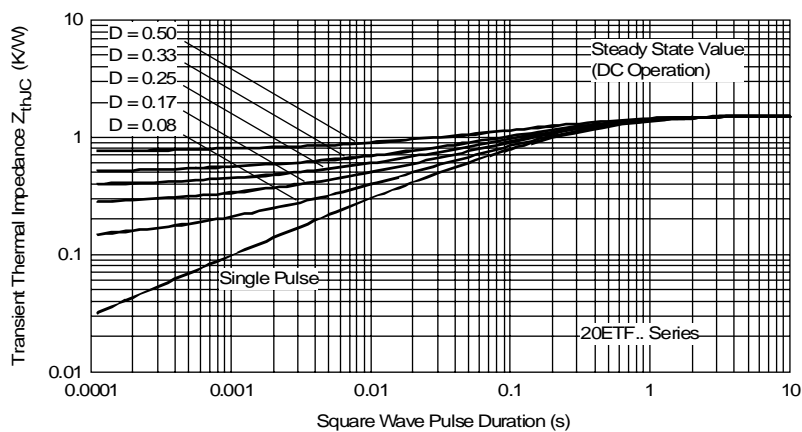
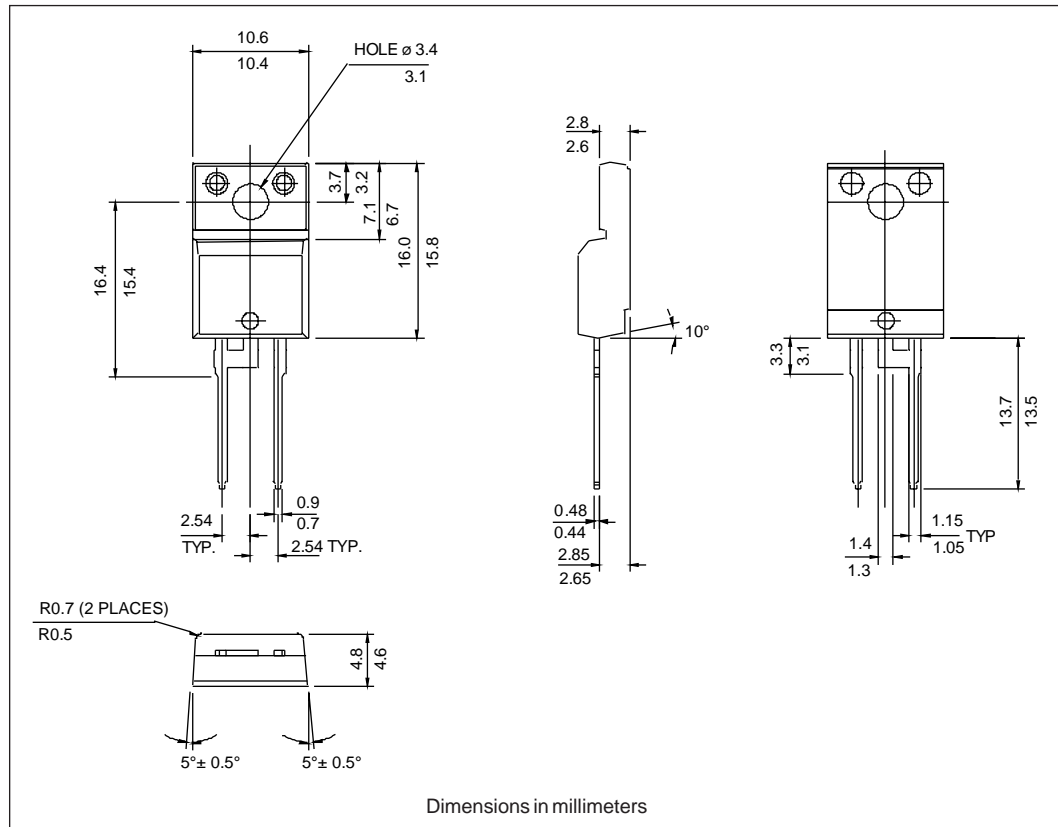

Fig. 14 - Thermal Impedance  $Z_{thJC}$  Characteristics

Outline Table



Ordering Information Table

