



LTS-1700 SERIES

1.02" SINGLE DIGIT NUMERIC DISPLAYS

FEATURES

- 1.02 INCH (26.0mm) DIGIT HEIGHT.
- CONTINUOUS UNIFORM SEGMENTS.
- CHOICE OF FIVE BRIGHT COLORS-RED/BRIGHT RED/GREEN/YELLOW/ORANGE.
- LOW POWER REQUIREMENT.
- EXCELLENT CHARACTERS APPEARANCE.
- HIGH BRIGHTNESS.
- WIDE VIEWING ANGLE.
- SOLID STATE RELIABILITY.
- CATEGORIZED FOR LUMINOUS INTENSITY.
- I.C. COMPATIBLE.
- EASY MOUNTING ON P.C. BOARD OR SOCKETS.

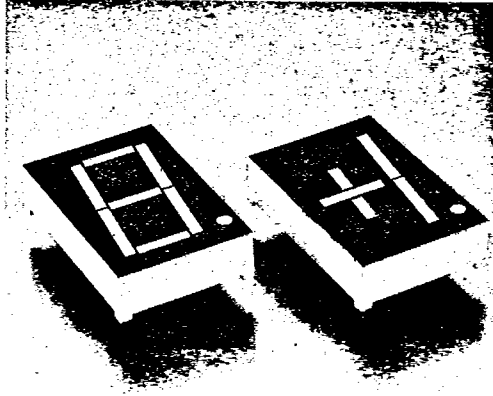

DESCRIPTION

The LTS-1700 series are 1.02 inch (26.0mm) height single digit displays.

The red series devices utilize LED chips which are made from GaAsP on a GaAs substrate. The bright red and green series devices utilize LED chips which are made from GaP on a transparent GaP substrate. The yellow and orange series devices utilize LED chips which are made from GaAsP on a transparent GaP substrate. All devices have gray face and white segment color.

DEVICES

PART NO. LTS--					DESCRIPTION	PACKAGE DIMENSION	INTERNAL CIRCUIT DIAGRAM
RED	BRIGHT RED	GREEN	YELLOW	ORANGE			
1720R	1720P	1720G	1720Y	1720E	Common Anode, Rt. Hand Decimal	A	A
1723R	1723P	1723G	1723Y	1723E	Common Cathode, Rt. Hand Decimal	A	B
1740R	1740P	1740G	1740Y	1740E	Common Anode, ± 1 Overflow	B	C
1743R	1743P	1743G	1743Y	1743E	Common Cathode, ± 1 Overflow	B	D

SEVEN-SEGMENT
LED DISPLAYS

6-142
617

PACKAGE DIMENSIONS

A. LTS-1720/1723

B. LTS-1740/1743

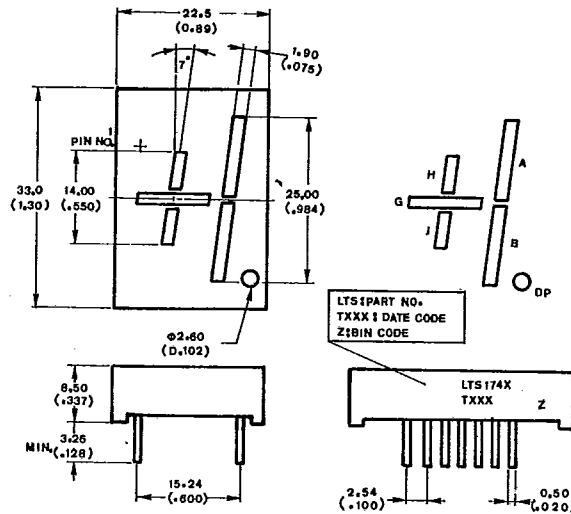
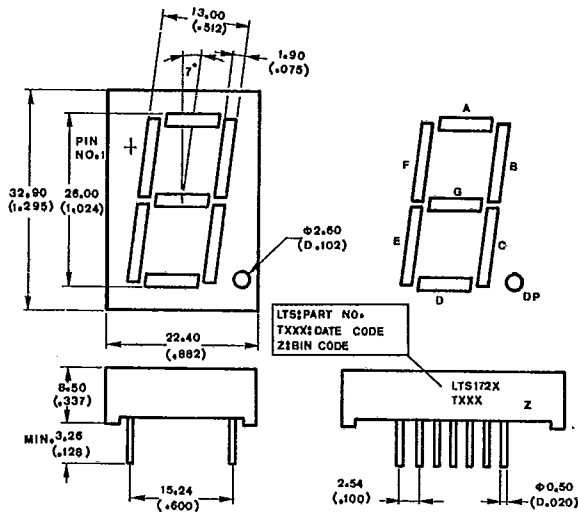

NOTE: All dimensions are in $\frac{\text{millimeters}}{\text{(inches)}}$, tolerance is $\frac{0.25\text{mm}}{(0.010'')}$ unless otherwise noted.

PIN CONNECTION

PIN NO.	CONNECTION			
	A. LTS-1720	B. LTS-1723	C. LTS-1740	D. LTS-1743
1	Cathode A	Anode A	No Pin	No Pin
2	Cathode F	Anode F	Cathode H, J	Anode H, J
3	Common Anode *1	Common Cathode *1	No Pin	No Pin
4	No Pin	No Pin	Cathode G	Anode G
5	No Pin	No Pin	Common Anode *2	Common Cathode *2
6	Common Anode *1	Common Cathode *1	No Pin	No Pin
7	Cathode E	Anode E	No Pin	No Pin
8	Cathode D	Anode D	No Pin	No Pin
9	Cathode D.P.	Anode D.P.	Cathode D.P.	Anode D.P.
10	Cathode C	Anode C	Cathode C	Anode C
11	Cathode G	Anode G	No Pin	No Pin
12	No Pin	No Pin	No Pin	No Pin
13	Cathode B	Anode B	Cathode B	Anode B
14	Common Anode *1	Common Cathode *1	Common Anode *2	Common Cathode *2

NOTES: 1. Pin 3, 6 & 14 are internally connected.
2. Pin 5 & 14 are internally connected.

INTERNAL CIRCUIT DIAGRAM

A. LTS-1720

B. LTS-1723

C. CLS-1740

D. LTS-1743

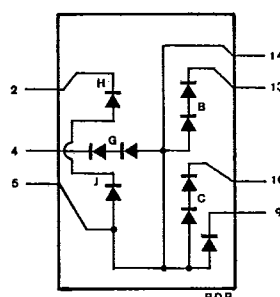
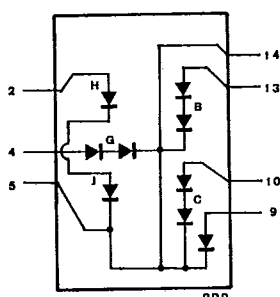
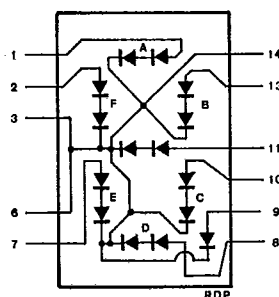
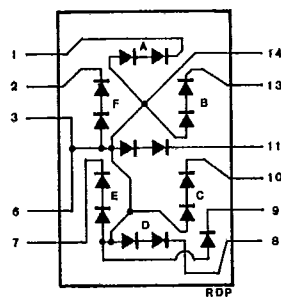

ABSOLUTE MAXIMUM RATINGS AT TA = 25°C

PARAMETER	RED	BRIGHT RED	GREEN	YELLOW	ORANGE	UNIT
Power Dissipation Per Segment	90	65	120	100	120	mW
Peak Forward Current Per Segment (1/10 Duty Cycle, 0.1ms Pulse Width)	160	60	100	80	100	mA
Continuous Forward Current Per Segment	25	15	25	20	25	mA
Derating Linear From 25°C Per Segment	0.3	0.18	0.3	0.24	0.3	mA/°C
Reverse Voltage Per Segment	10	10	10	10	10	V
Operating Temperature Range	-25°C to +85°C					
Storage Temperature Range	-25°C to +85°C					
Solder Temperature 1/16 inch Below Seating Plane for 3 Seconds at 260°C						

SEVEN-SEGMENT LED DISPLAYS

ELECTRICAL/OPTICAL CHARACTERISTICS AT $T_A = 25^\circ\text{C}$
LTS-1700R SERIES

PARAMETER	SYMBOL	MIN.	TYP.	MAX.	UNIT	TEST CONDITION
Average Luminous Intensity	I_v	400	1200		μcd	$I_F = 10\text{ mA}$
Peak Emission Wavelength	λ_p		655		nm	$I_F = 20\text{ mA}$
Spectral Line Half-Width	$\Delta\lambda$		24		nm	$I_F = 20\text{ mA}$
Forward Voltage, any Segment	V_F		3.4	4.0	V	$I_F = 20\text{ mA}$
Reverse Current, any Segment	I_R			100	μA	$V_R = 10\text{ V}$
Luminous Intensity Matching Ratio	$I_v\text{-m}$			2:1		$I_F = 20\text{ mA}$

Note: The BIN brightness classification see page 6-161, category C

TYPICAL ELECTRICAL/OPTICAL CHARACTERISTIC CURVES

(25°C Ambient Temperature Unless Otherwise Noted)

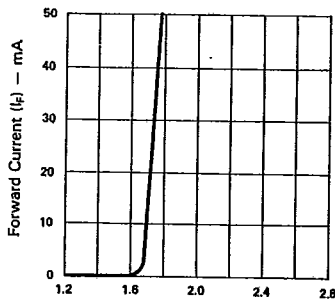

Fig. 1 FORWARD CURRENT Vs. FORWARD VOLTAGE.

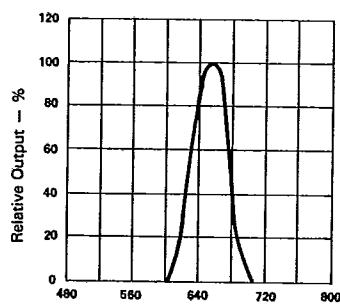

Fig. 2 SPECTRAL RESPONSE.

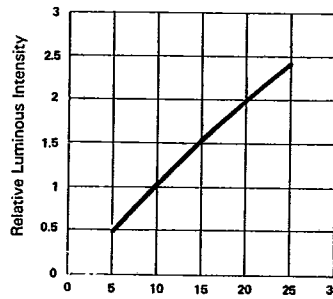

Fig. 3 RELATIVE LUMINOUS INTENSITY Vs. FORWARD CURRENT (PER SEGMENT).

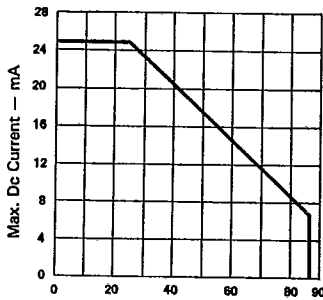

Fig. 4 MAX. ALLOWABLE DC CURRENT PER SEG. Vs AMBIENT TEMPERATURE.

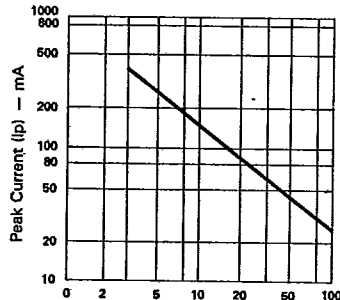

Fig. 5 MAX. PEAK CURRENT Vs. DUTY CYCLE.% (REFRESH RATE - F = 1 KHz)

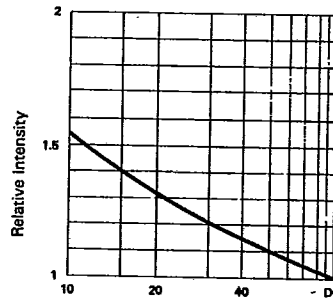

Fig. 6 LUMINOUS INTENSITY Vs. DUTY CYCLE% (AVERAGE $I_F = 10\text{ mA}$ PER SEG.)

ELECTRICAL/OPTICAL CHARACTERISTICS AT TA = 25°C
LTS-1700P SERIES

PARAMETER	SYMBOL	MIN.	TYP.	MAX.	UNIT	TEST CONDITION
Average Luminous Intensity	I_v	650	2000		μcd	$I_F = 10 \text{ mA}$
Peak Emission Wavelength	λ_p		697		nm	$I_F = 20 \text{ mA}$
Spectral Line Half-Width	$\Delta\lambda$		90		nm	$I_F = 20 \text{ mA}$
Forward Voltage, any Segment	V_F		4.2	5.6	V	$I_F = 20 \text{ mA}$
Reverse Current, any Segment	I_R			100	μA	$V_R = 10\text{V}$
Luminous Intensity Matching Ratio	$I_v\text{-m}$			2:1		$I_F = 20 \text{ mA}$

Note: The BIN brightness classification see page 6-161, category C

TYPICAL ELECTRICAL/OPTICAL CHARACTERISTIC CURVES

(25°C Ambient Temperature Unless Otherwise Noted)

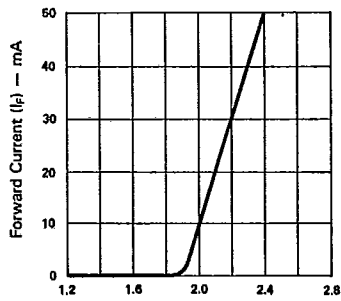

Fig. 1 FORWARD CURRENT Vs. FORWARD VOLTAGE.

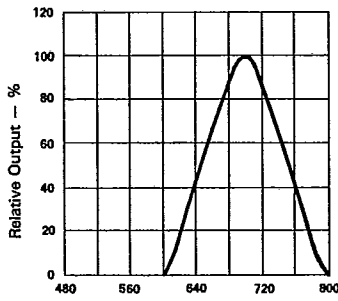

Fig. 2 SPECTRAL RESPONSE.

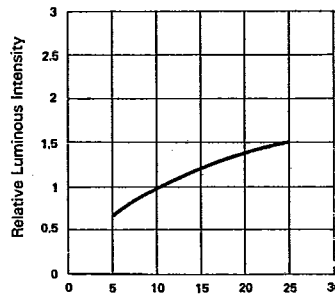

Fig. 3 RELATIVE LUMINOUS INTENSITY Vs. FORWARD CURRENT (PER SEGMENT).

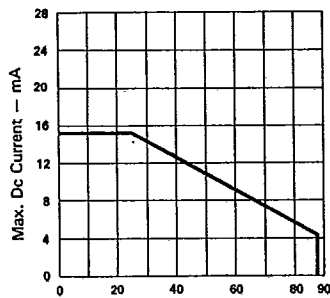

Fig. 4 MAX. ALLOWABLE DC CURRENT PER SEG. Vs AMBIENT TEMPERATURE.

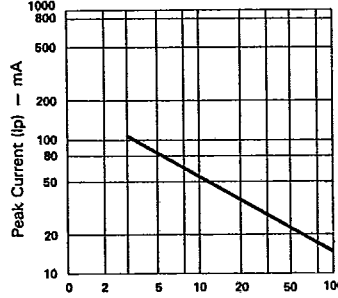

Fig. 5 MAX. PEAK CURRENT Vs. DUTY CYCLE.% (REFRESH RATE - F = 1 KHz)

SEVEN-SEGMENT
LED DISPLAYS

**ELECTRICAL/OPTICAL CHARACTERISTICS AT TA = 25°C
LTS-1700G SERIES**

PARAMETER	SYMBOL	MIN.	TYP.	MAX.	UNIT	TEST CONDITION
Average Luminous Intensity	I_v	1600	4800		μcd	$I_F = 10 \text{ mA}$
Peak Emission Wavelength	λ_p		565		nm	$I_F = 20 \text{ mA}$
Spectral Line Half-Width	$\Delta\lambda$		30		nm	$I_F = 20 \text{ mA}$
Forward Voltage, any Segment	V_F		4.2	5.6	V	$I_F = 20 \text{ mA}$
Reverse Current, any Segment	I_R			100	μA	$V_R = 10\text{V}$
Luminous Intensity Matching Ratio	$I_v\text{-m}$			2:1		$I_F = 20 \text{ mA}$

Note: The BIN brightness classification see page 6-161, category C

TYPICAL ELECTRICAL/OPTICAL CHARACTERISTIC CURVES

(25°C Ambient Temperature Unless Otherwise Noted)

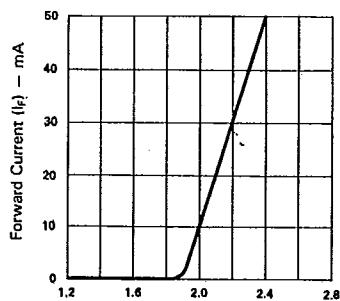

Fig. 1 FORWARD CURRENT Vs. FORWARD VOLTAGE.

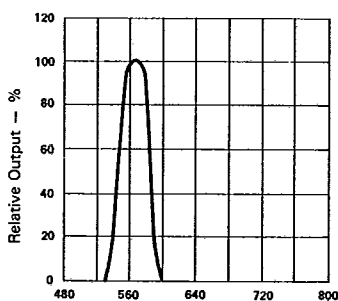

Fig. 2 SPECTRAL RESPONSE.

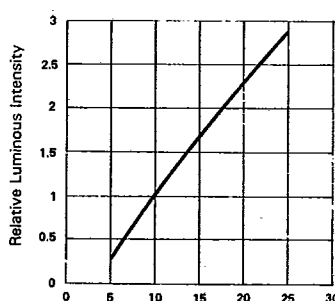

Fig. 3 RELATIVE LUMINOUS INTENSITY Vs. FORWARD CURRENT (PER SEGMENT).

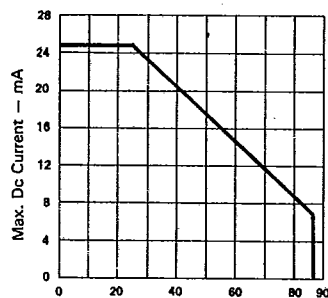

Fig. 4 MAX. ALLOWABLE DC CURRENT PER SEG. Vs AMBIENT TEMPERATURE.

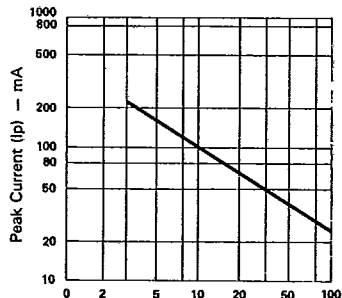

Fig. 5 MAX. PEAK CURRENT Vs. DUTY CYCLE.% (REFRESH RATE - F = 1 KHz)

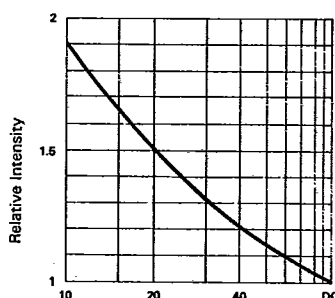

Fig. 6 LUMINOUS INTENSITY Vs. DUTY CYCLE% (AVERAGE $I_F = 10\text{mA}$ PER SEG.)

ELECTRICAL/OPTICAL CHARACTERISTICS AT TA = 25°C
LTS-1700Y SERIES

PARAMETER	SYMBOL	MIN.	TYP.	MAX.	UNIT	TEST CONDITION
Average Luminous Intensity	I_v	1400	4800		μcd	$I_F = 10 \text{ mA}$
Peak Emission Wavelength	λ_p		585		nm	$I_F = 20 \text{ mA}$
Spectral Line Half-Width	$\Delta\lambda$		35		nm	$I_F = 20 \text{ mA}$
Forward Voltage, any Segment	V_F		4.2	5.6	V	$I_F = 20 \text{ mA}$
Reverse Current, any Segment	I_R			100	μA	$V_R = 10\text{V}$
Luminous Intensity Matching Ratio	$I_v\text{-m}$			2:1		$I_F = 20 \text{ mA}$

Note: The BIN brightness classification see page 6-161, category C

TYPICAL ELECTRICAL/OPTICAL CHARACTERISTIC CURVES

(25°C Ambient Temperature Unless Otherwise Noted)

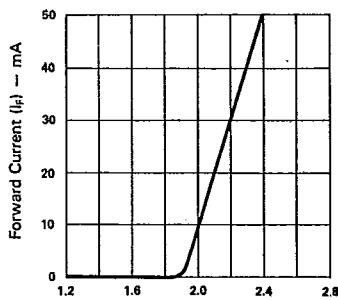

Fig. 1 FORWARD CURRENT Vs. FORWARD VOLTAGE.

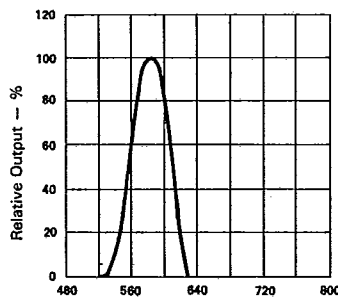

Fig. 2 SPECTRAL RESPONSE.

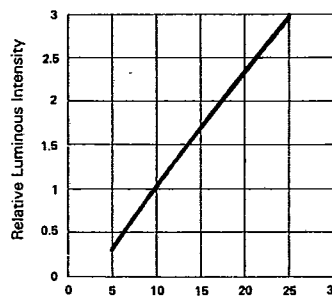

Fig. 3 RELATIVE LUMINOUS INTENSITY Vs. FORWARD CURRENT (PER SEGMENT).

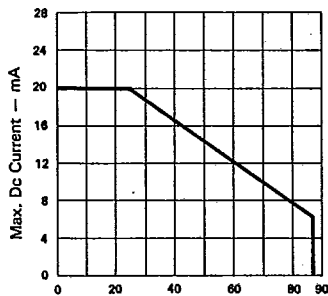

Fig. 4 MAX. ALLOWABLE DC CURRENT PER SEG. Vs AMBIENT TEMPERATURE.

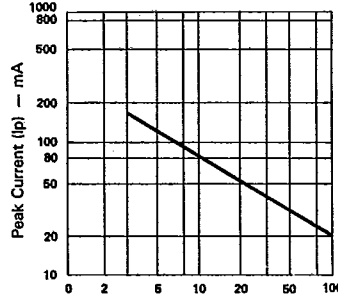

Fig. 5 MAX. PEAK CURRENT Vs. DUTY CYCLE.% (REFRESH RATE - F = 1 KHz)

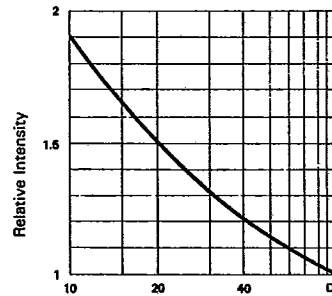

Fig. 6 LUMINOUS INTENSITY Vs. DUTY CYCLE% (AVERAGE $I_f = 10\text{mA}$ PER SEG.)

SEVEN-SEGMENT
LED DISPLAYS

**ELECTRICAL/OPTICAL CHARACTERISTICS AT $T_A = 25^\circ\text{C}$
LTS-1700E SERIES**

PARAMETER	SYMBOL	MIN.	TYP.	MAX.	UNIT	TEST CONDITION
Average Luminous Intensity	I_v	2200	4800		μcd	$I_F = 10 \text{ mA}$
Peak Emission Wavelength	λ_p		630		nm	$I_F = 20 \text{ mA}$
Spectral Line Half-Width	$\Delta\lambda$		40		nm	$I_F = 20 \text{ mA}$
Forward Voltage, any Segment	V_F		4.2	5.6	V	$I_F = 20 \text{ mA}$
Reverse Current, any Segment	I_R			100	μA	$V_R = 10\text{V}$
Luminous Intensity Matching Ratio	$I_v\text{-m}$			2:1		$I_F = 20 \text{ mA}$

Note: The BIN brightness classification see page 6-161, category C

TYPICAL ELECTRICAL/OPTICAL CHARACTERISTIC CURVES

(25°C Ambient Temperature Unless Otherwise Noted)

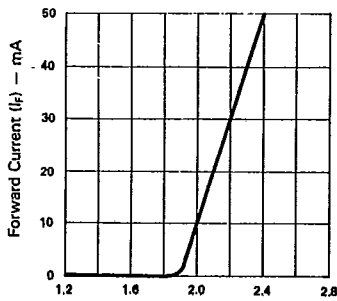

Fig. 1 FORWARD CURRENT Vs. FORWARD VOLTAGE.

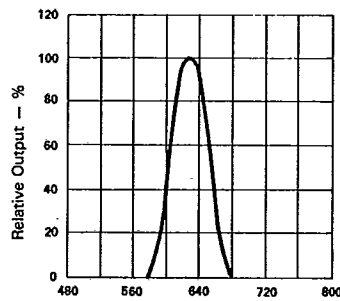

Fig. 2 SPECTRAL RESPONSE.

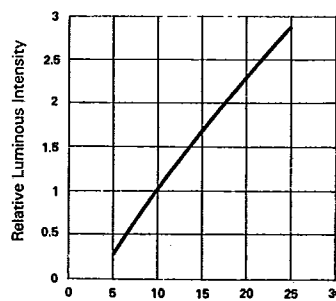

Fig. 3 RELATIVE LUMINOUS INTENSITY Vs. FORWARD CURRENT (PER SEGMENT).

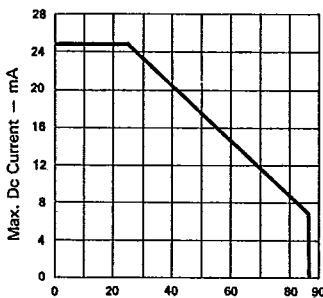

Fig. 4 MAX. ALLOWABLE DC CURRENT PER SEG. Vs AMBIENT TEMPERATURE.

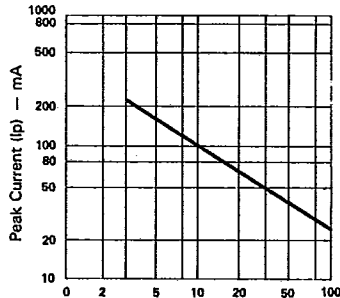

Fig. 5 MAX. PEAK CURRENT Vs. DUTY CYCLE.% (REFRESH RATE - F = 1 KHz)

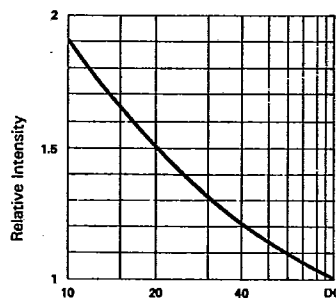

Fig. 6 LUMINOUS INTENSITY Vs. DUTY CYCLE% (AVERAGE $I_F = 10\text{mA}$ PER SEG.)