

# RECTIFIER ASSEMBLIES

High Voltage Doorbell® Modules,  
Standard and Fast Recovery

UDA, UDB, UDC, UDD ,  
UDE, UDF SERIES

## FEATURES

- PIV: from 2.5kV to 15kV
- Stackable to 600kV
- Current Ratings: to 7.7A
- Controlled Avalanche Characteristics
- Only Fused-in-Glass Diodes Used
- Recovery Time: to 500ns
- Modular Package For Easy Stacking

## DESCRIPTION

This series of high-voltage, high-current stacks that incorporate a unique modular design makes it ideally suited for high power applications such as in radar systems as charger, hold-off and clipper diodes.

## ABSOLUTE MAXIMUM RATINGS

Peak Inverse Voltage

UDA, UDC Series .....	5kV to 15kV
UDB, UDD Series .....	2.5kV to 7.5kV
UDE, UDF Series .....	2.5kV to 5kV

Maximum Average D.C. Output Current ..... See Electrical Specifications

Non-Repetitive Sinusoidal Surge (8.3ms) ..... See Electrical Specifications

Operating and Storage Temperature, T<sub>C</sub> ..... -65°C to +150°C

## MECHANICAL SPECIFICATIONS

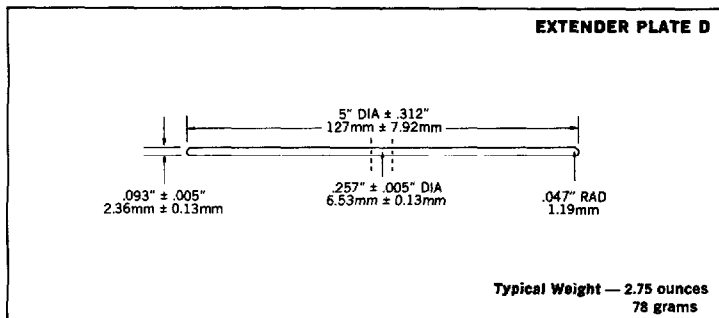
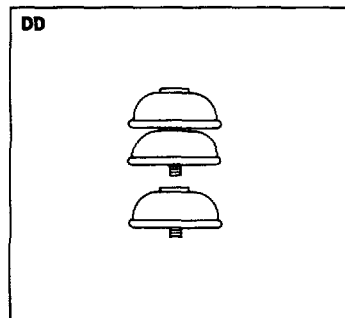
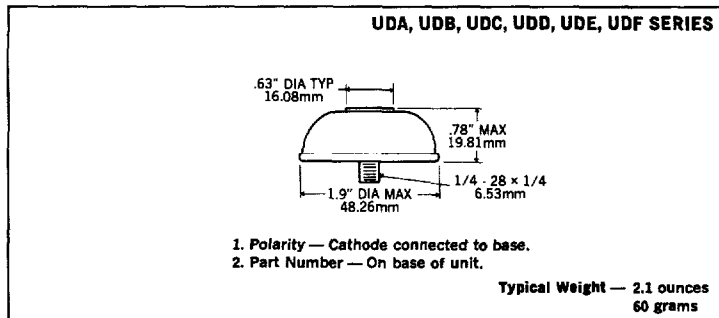

**Microsemi Corp.**  
**Watertown**  
*The diode experts*

Type		PIV	Maximum Forward Voltage Drop	Maximum Leakage Current @ PIV	Maximum Reverse Recovery Time	Maximum Average D.C. Output Current			Non-Repetitive Sinusoidal Surge (8.3ms) T <sub>C</sub> = 100°C	Maximum Reverse Transient Energy Absorption
						T <sub>C</sub> = 75°C Air				
						T <sub>C</sub> = 60°C Air with Extender Plate**	T <sub>C</sub> = 50°C Oil	Amperes		
Standard Recovery	UDE-2.5	2.5	5V @ 3.00A	10	ns	‡ 6.00	7.00	7.70	200	8
	UDB-2.5	2.5	4V @ 1.50A	5		3.00	3.75	4.25	100	4
	UDE-5	5	10V @ 2.20A	10		‡ 4.50	5.00	5.50	200	14
	UDB-5	5	8V @ 1.00A	5		2.00	2.50	2.75	100	8
	UDA-5	5	8V @ 0.82A	2	—	1.65	2.00	2.20	30	1.5
	UDB-7.5	7.5	12V @ 0.70A	5		1.33	1.65	2.00	100	12
	UDA 7.5	7.5	12V @ 0.60A	2		1.25	1.55	1.75	30	2.5
	UDA-10	10	16V @ 0.50A	2		1.00	1.25	1.40	30	3
	UDA-15	15	25V @ 0.33A	2		0.67	0.80	0.90	30	5
Fast Recovery	UDF-2.5	2.5	6V @ 2.20A	10		4.50	5.00	5.30	150	8
	UDD-2.5	2.5	6V @ 1.20A	5		2.25	2.80	3.30	80	4
	UDF-5	5	11V @ 1.60A	10		3.30	4.00	4.40	150	14
	UDD-5	5	11V @ 0.75A	5		1.50	1.85	2.00	80	8
	UDC-5	5	10V @ 0.70A	2	500*	1.20	1.50	1.70	25	1.5
	UDD-7.5	7.5	17V @ 0.50A	5	350†	1.00	1.25	1.50	80	12
	UDC-7.5	7.5	15V @ 0.50A	2		0.90	1.10	1.25	25	2.5
	UDC-10	10	20V @ 0.37A	2		0.75	0.90	1.00	25	3
	UDC-15	15	30V @ 0.25A	2		0.50	0.60	0.70	25	5

\*Measured in a reverse recovery circuit switching from 1.0A forward to 1.0A reverse current recovering to 0.5A.

†Measured in a reverse recovery circuit switching from 0.5A forward to 1.0A reverse current recovering to 0.25A.

\*\*These ratings are based on using "extender plates" that provide additional surface area to radiate heat. Because of possible corona effects caused by scratches on these plates, extreme care is necessary in their handling and they are not recommended where the working voltage exceeds 7.5KV/module. They should be carefully polished prior to installation.

‡These ratings are based on T<sub>C</sub> = 100°C.

Forward Pulse Current vs. Pulse Duration

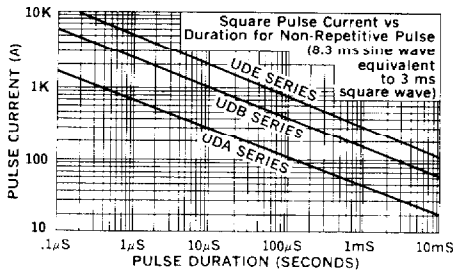

Forward Pulse Current vs. Pulse Duration

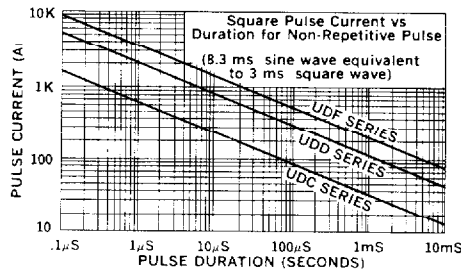

Typical Forward Voltage vs. Forward Current

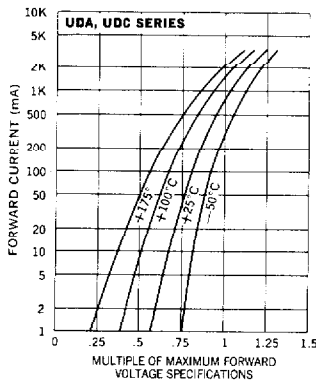

Typical Forward Voltage vs. Forward Current

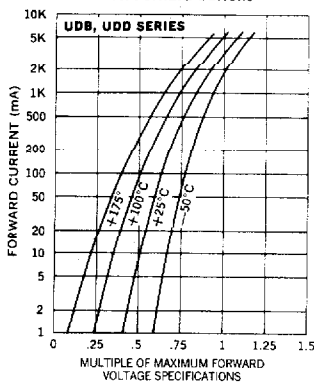

Typical Forward Voltage vs. Forward Current

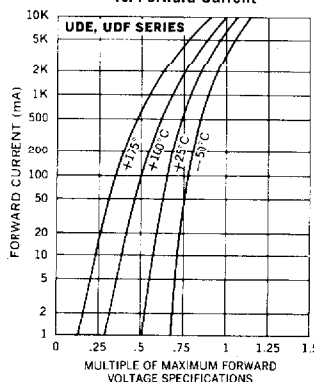

Typical Leakage Current vs. PIV

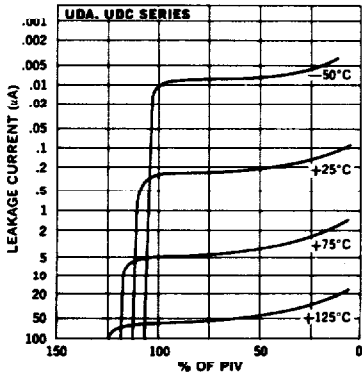

Typical Leakage Current vs. PIV

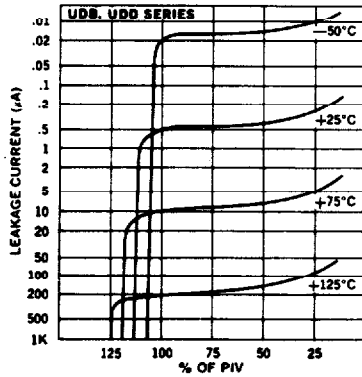

Typical Leakage Current vs. PIV

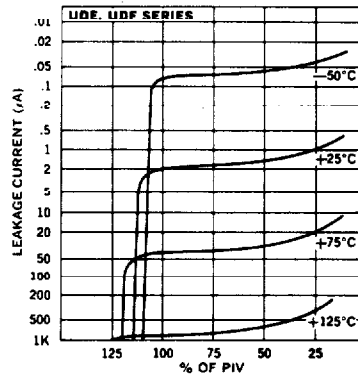

Multiple Surge Rating vs. Duration

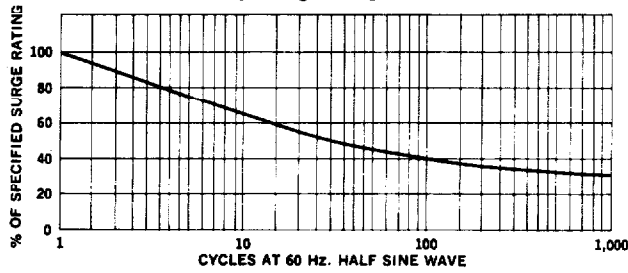

Output Current Ratio vs. Velocity of Air Flow

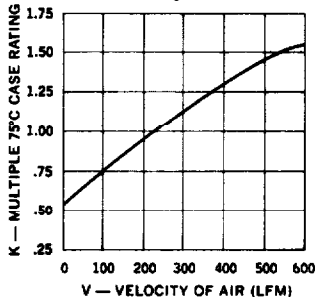

Current Derating Curve

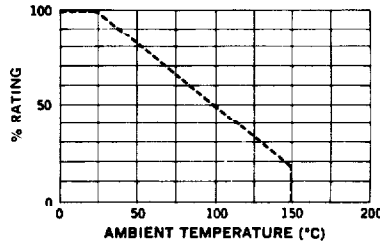

Current Derating Curve

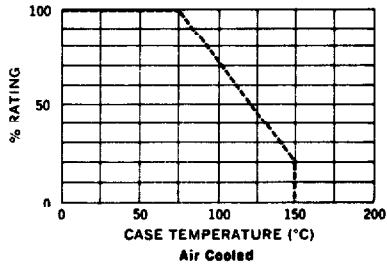

Current Derating Curve

