

## 1. Application

This data sheet is to introduce the specification of LM641521, Passive Matrix type LCD Unit.

## 2. Construction and Outline

Construction: 640X480 dots display unit consisting of an LCD panel, PWB (printed wiring board) with electric components mounted onto, tab (tape automated bonding) to connect the LCD panel and PWB electrically, and plastic cabinets to fix them mechanically.

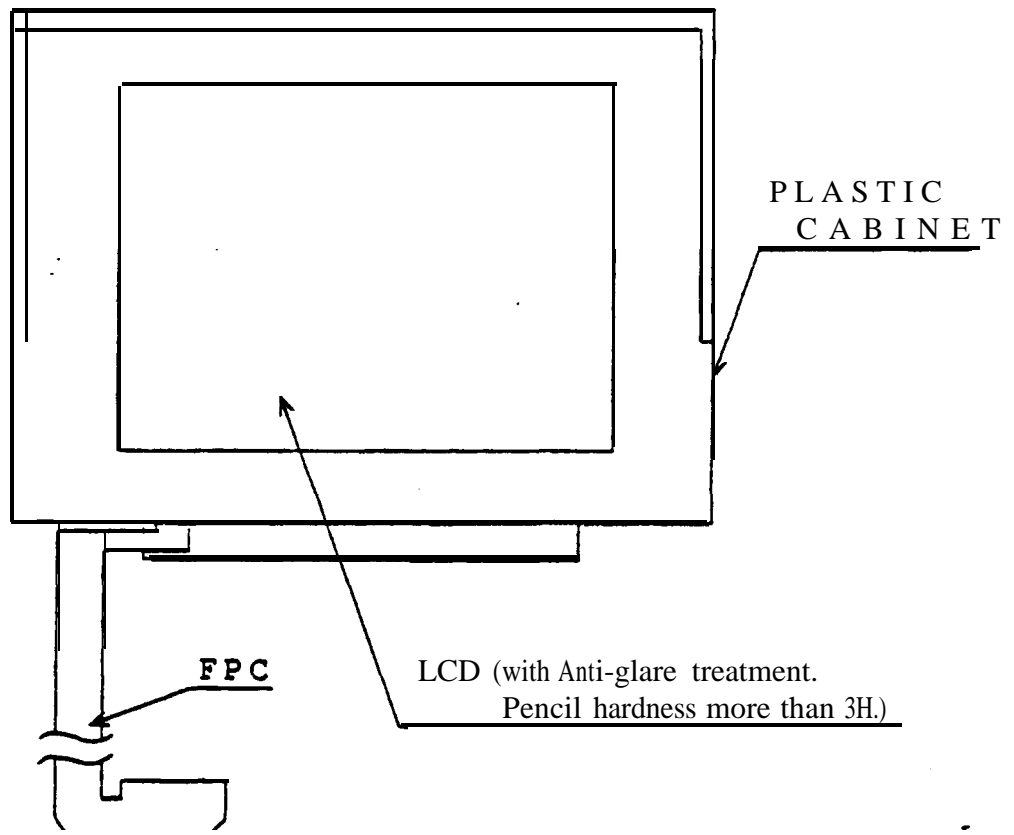

Outline : See lit 8

Connect ioa : See Fig. 8 and Table 8

## 3. Mechanical Specifications

Table 1

Parameter	Specifications	Unit
Outline dimensions	279.4 (W) × 198.85 (H) × 24.59 MAX (D) #1	mm
Effective viewing Area	196 (W) × 147.6 (H)	mm
Display format	640 (W) × 480 (H) full dot	-
Dot size	0.27 × 0.27	mm
Dot spacing	0.03	mm
*2 Dot color	Black#3	-
*2 Background color	White#3	-
Weight	Approx. 380	g

#1 Excluded PPC.

#2 Due to the characteristics of the LC material the colors vary with environmental temperature.

#3 Positive-type display  
 Displayed data \*H\*: Dots ON : Black  
 Displayed data \*L\*: Dots off: White

## 4. Absolute Maximum Ratings

4-L Electrical absolute maximum ratings

Table 2

Parameter	Symbol	MIN.	MAX.	Unit	Remark
Supply voltage (Logic)	V <sub>DD-VSS</sub>	0	6.0	V	T <sub>a</sub> =25°C
Supply voltage (LCD drive)	V <sub>DD-VZZ</sub>	0	30.0	V	T <sub>a</sub> =25°C
Input voltage	V <sub>IN</sub>	0			T <sub>a</sub> =25°C

4-2 Environmental Conditions

Table 3

Item	Tstg		Topr		Remark
	MIN.	Max.	Min.	MAX.	
Ambient temperaturer	-25 C	+60 C	0C	+45C	Note 2
Humidity	Note		Note 1		No condensat ion
Vibration	Note 2		Note 2		3 directions (X/Y/Z)
Shock	Note 3		Note 3..		6 directions (+X+Y+Z)

Note 1) Ta<40C . . . .95% RH Max  
 Ta>40C . . . .Absolute humidity shall be less than Ta=40C/95% RH

Note 2)

Frequency	5Hz~23Hz	23Hz~500Hz
Vibratioo level	-	1. 0G
Vibration width	1. 0mm	-
Interval	5Hz~500Hz~5Hz/26. 6min	

2 hoars for each direction of X/Y/Z (6 hoars as total)

Note 3) Accerelation : 50G  
 Pulse width : 1ms  
 3 times for each direction of +X/+Y/+Z

Note 4) Care **should** be taken so that the LCD Unit ~~may~~not be subjected to the temperature out of this specification

5. Electrical Specifications

5-1 Electrical characteristics



**Table 4** Ta=25°C, Vdd=5V± 5%

Parameter	Symbol	Conditions	Min.	Typ.	Max.	Unit
Supply voltage (Logic)	V <sub>DD</sub> -V <sub>SS</sub>		4.75	5.0	5.25	V
Supply voltage (LCD drive)	V <sub>ZX</sub> -V <sub>SS</sub>	Note 1) Note 2)	-23.0	-18.7	-14.1	V
Input signal voltage	V <sub>IZ</sub>	'H' level	0.8V <sub>DD</sub>	—	V <sub>DD</sub>	V
		'L' level	0	—	0.2V <sub>DD</sub>	V
Input leakage current	I <sub>IZ</sub>	'H' level	—	—	250	μA
		'L' level	-250	—	—	μA
Supply current (Logic)	I <sub>DD</sub>	Note 3)	—	23.0	33.0	mA
Supply current (LCD drive)	I <sub>ZX</sub>		—	17.5	27.0	mA
Power consumption	Pd		—	450	680	mW

Note 1) The viewing angle  $\theta$  at which the optimum contrast is obtained by adjusting V<sub>ZX</sub>-V<sub>SS</sub>. Refer to Fig.4 for the definition of  $\theta$ .

Note 2) Max. and Min. values are specified as the Max. and Min. voltage within the condition of operational temperature range (0~45°C).  
Typ. values are specified as the typical voltage at 25°C.

Note 3) Display high frequency pattern.

V<sub>DD</sub> = 5V, V<sub>ZX</sub> - V<sub>SS</sub> = -18.7V, Frame frequency = 85Hz, Display pattern = 4bit checker display  
 display   
 pattern   

5-2 Input capacitance

**Table 5**

Signal	Input capacitance
S	40pF TYP
CP1, DISP	250pF TYP
CP2	200pF TYP
DU0~DU3	200pF TYP
DLO~DL3	200pF TYP

## 5-3 Interface signals

table 6

Used connector : 1mm Pitch PPC (27 pins)

Pin No	Symbol	Description	Level
1	V <sub>SS</sub>	Ground potential	
2	V <sub>SS</sub>	Ground potential	
3	V <sub>SS</sub>	Ground potential	
4	s	Scan start-up signal	'H'
5	CP1	Input data latch signal	H→L
6	CP2	Data input clock signal	H→L
7	DISP	Display control signal	Display on .. 'H' off .. 'L'
8	V <sub>DD</sub>	Power supply for logic and LCD (+5V)	-
9	V <sub>SS</sub>	Ground potential	
10	V <sub>V2</sub>	Power supply for LCD I-1	
11	DU0	Display data signal (Upper half)	H (ON), L (OFF)
12	DU1		
13	DU2		
14	DU3		
15	DLO	Display data signal (Lower half)	H (ON), L (OFF)
16	DL1		
17	DL2		
18	DL3		
19	V <sub>SS</sub>	Ground potential	-
20	V <sub>SS</sub>	Ground potential	-
21	V <sub>SS</sub>	Ground potential	-
22~27	-	(Not to connected with LCD circuit)	

Note) Pin No. and its location are shown in Fig. 8.

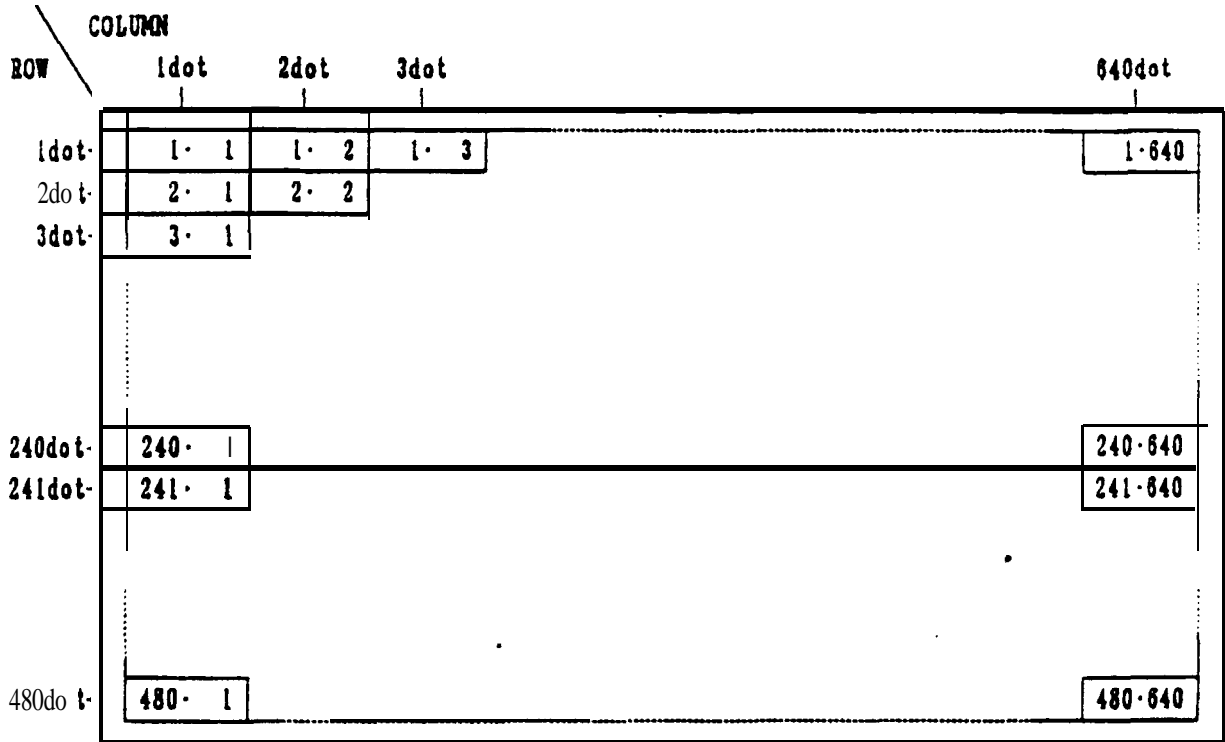

Note) 1·2 means 1st row 2nd column dot.

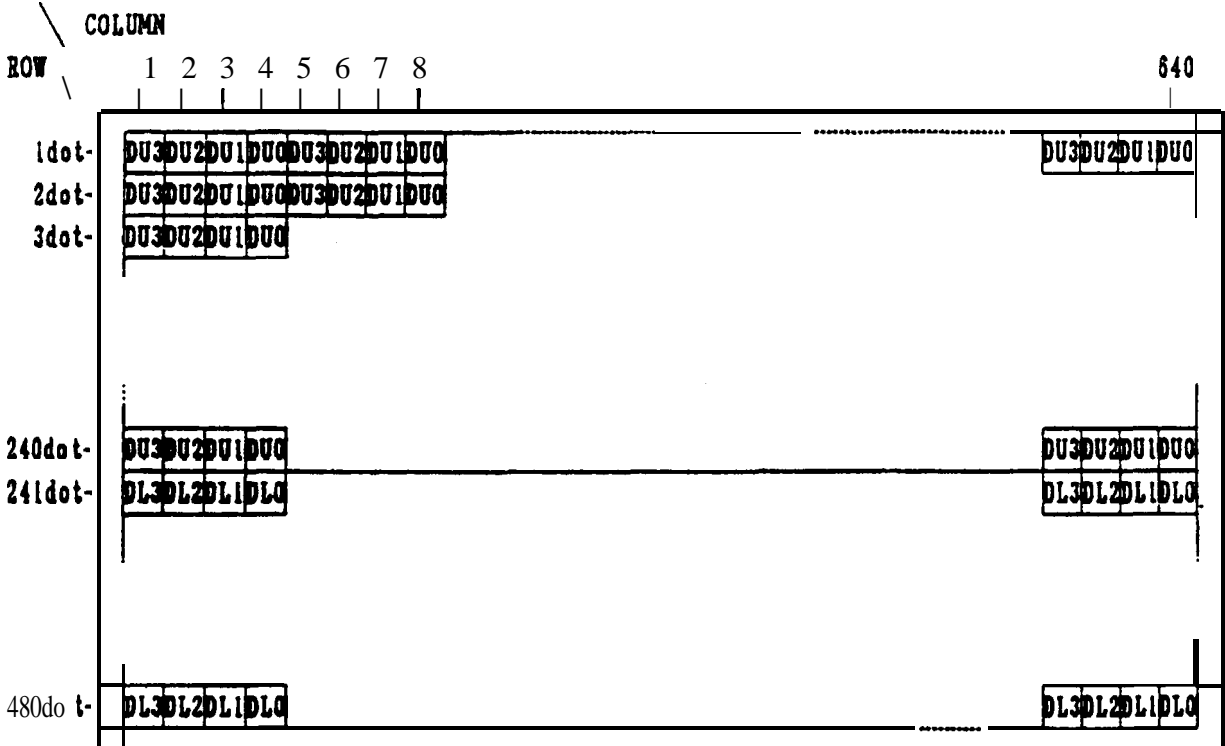

Fig. Dot chart of display area

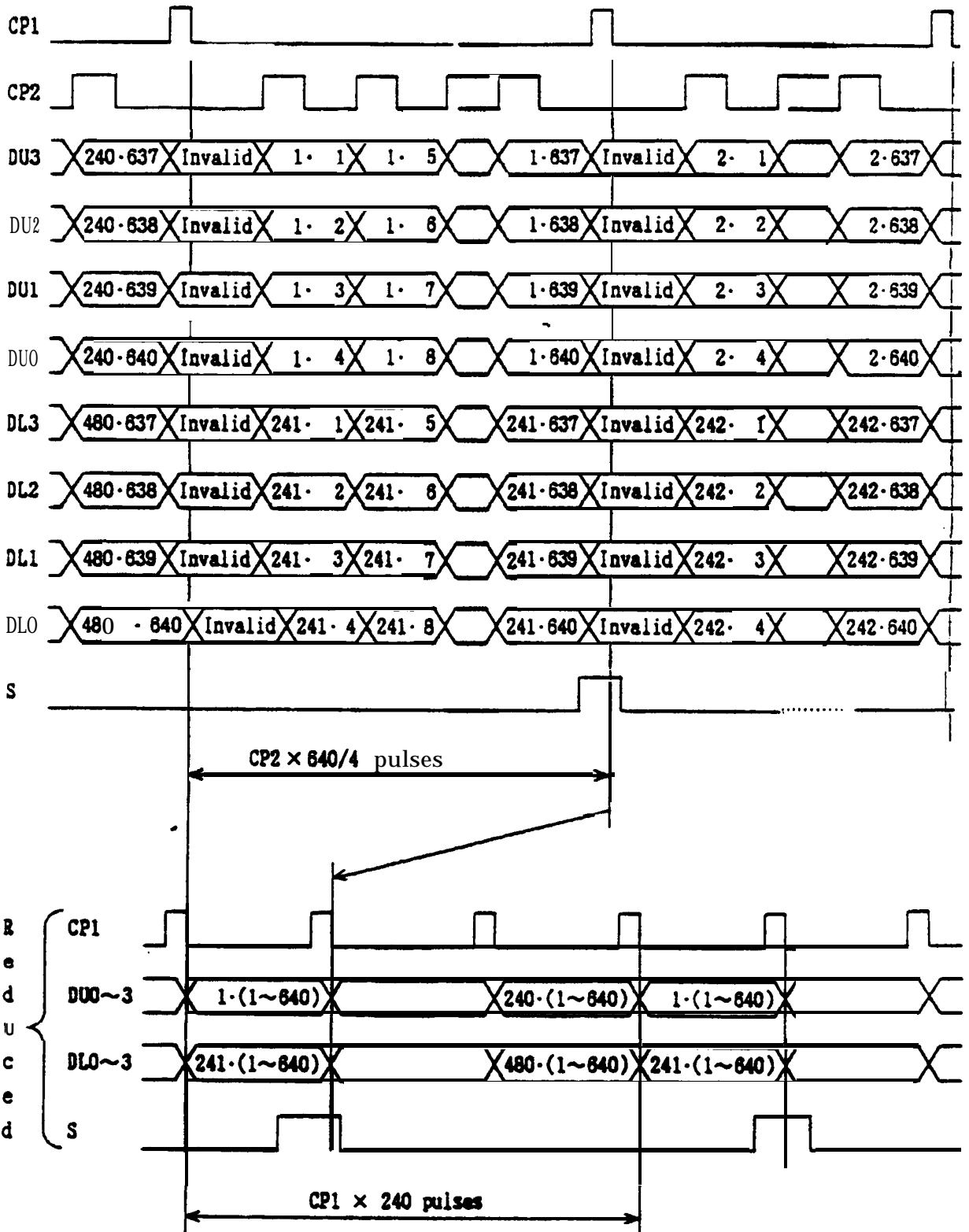
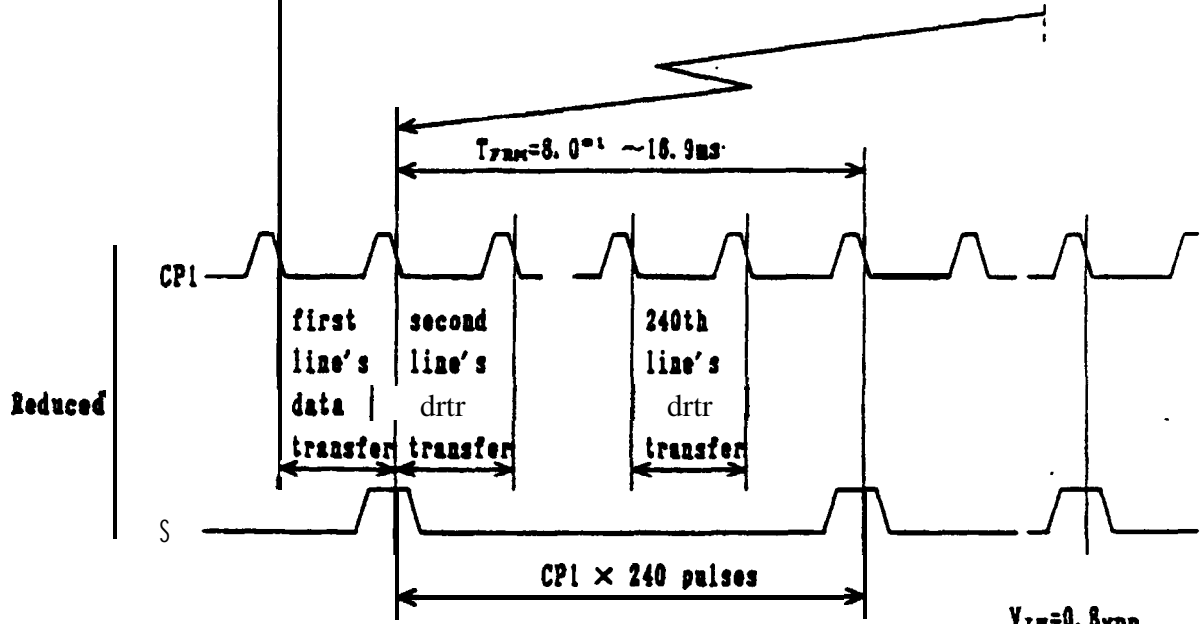
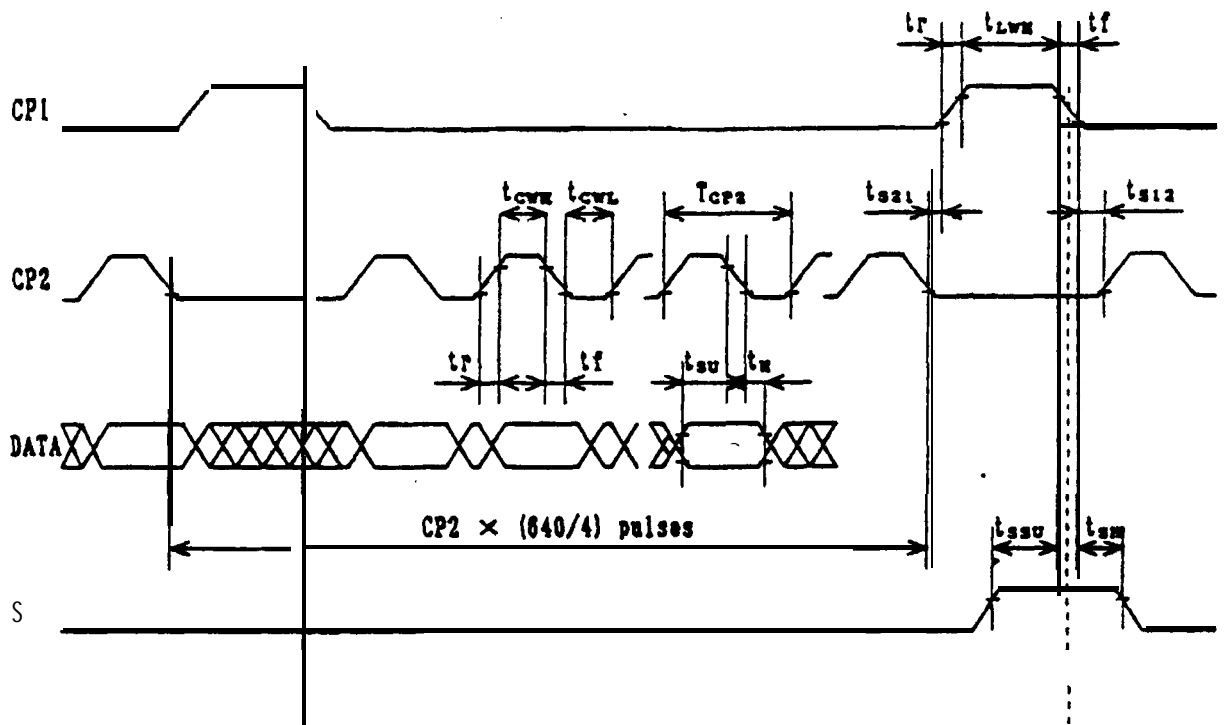

Fig.2 Data input timing



\* 1 See table 7

$V_{IH} = 0.8V_{DD}$   
 $V_{IL} = 0.2V_{DD}$

Fig. 3 Interface timing chart



Table 7 Interface timing ratings

Item	Symbol	Rating			Unit
		MIN.	TYP.	MAX.	
Frame cycle	$T_{FM}$	8.0 <sup>*1</sup>		16.9	ns
CP2 clock cycle	$T_{CP2}$	152			ns
'H' level clock width	$t_{CWH}$	85			ns
'L' level clock width	$t_{CWL}$	85			ns
● 'H' level latch clock width	$t_{LWH}$	70			ns
Data set up time	$t_{SU}$	50			ns
Data hold time	$t_H$	40			ns
S set up time	$t_{SSU}$	100			ns
S hold time	$t_{SH}$	100			ns
CP2 ↑ clock allowance time from CP1 ↓	$t_{S1}$	0			ns
CP1 ↑ clock allowance time from CP2 ↓	$t_{S2}$	0			ns
Clock rise/fall time	$t_r, t_f$			$t_{rz}$ <sup>*2</sup>	ns

\*1 : LCD unit functions at the ● inimum frame cycle of 8 ns (Maximum frame frequency of 125Hz). Owing to the characteristics of LCD unit, 'shadowing' will become more eminent as frame frequency goes up, while flicker will be reduced.

According to our experiments, frame cycle of 11.7 ns Min. or frame frequency of 85 Hz Max. will demonstrate optimum display quality in terms of flicker and 'shadowing'. But since judgement of display quality is subjective and display quality such as 'shadowing' is pattern dependent, it is recommended that decision of frame cycle or frame frequency, to which power consumption of the LCD unit is proportional, be made based on your own through testing on the LCD unit with every possible patterns displayed on it.

\*2 :  $t_{rz} = 50$  in case  $t_{cr} = (T_{CP2} - t_{CWH} - t_{CWL}) / 2 \geq 50$   
 $t_{rz} = t_{cr}$  in case  $t_{cr} = (T_{CP2} - t_{CWH} - t_{CWL}) / 2 < 50$

## 6. Unit Driving Method

### 6.1 Circuit configuration

Fig. 7 shows the block diagram of the Unit's circuit.

### 6.2 Display Face Configuration

The display face electrically consists of two (upper and lower) display segments so that the unit may offer higher contrast by reducing drive duty ratio. Each display segment (640 × 240 dots) is driven at 1/240 duty ratio.

### 6.3 Input Data and Control Signal

The LCD driver is 80 bits LSI, consisting of shift registers, latch circuits and LCD driver circuits.

Display data which are externally divided into data for each row (640 dots) will be sequentially transferred in the form of 1-bit parallel data through shift registers by Clock Signal CP2 from the left top of the display face.

When data of one row (640 dots) have been input, they will be latched in the form of parallel data for 640 lines of signal electrodes by latch signal CP1. Then the corresponding drive signal will be transmitted to the 640 lines of column electrodes of the LCD panel by the LCD drive circuits.

At this time, scan start-signal S has been transferred from the scan signal driver to the 1st row of scan electrodes, and the contents of the data signals are displayed on the 1st rows of upper and lower half of the display face according to the combinations of voltages applied to the scan and signal electrodes of the LCD.

While the 1st row of data are being displayed, the 2nd rows of data are entered. When 640 dots of data have been transferred and latched on the falling edge of CP1 clock, the display face proceeds to the 2nd rows of display.

Such driver input will be repeated up to the 240th row of each display segment, from upper to lower rows, to complete one frame of display by time sharing method. Then data input proceeds to the next display face.

Scan start-signal S generates scan signal to drive horizontal electrodes.

Since DC voltage, if applied to LCD panel, causes chemical reaction which will deteriorate LCD panel, drive waveform shall be inverted at every display frame to prevent the generation of such DC voltage. Control Signal M plays such a role.

Because of the characteristics of the CMOS driver LSI, the power consumption of the unit goes up as the operating frequency CP2 increases. Thus the driver LSI applies the system of transferring 4-bits parallel data through the 4 lines of shift registers to reduce the data transfer speed CP2. Thanks to the LSI, the power consumption of the unit will be minimized.

In this circuit configuration, I-bit display data shall be therefore input to data input pins of DU<sub>0-3</sub> (upper display segment) and DL<sub>0-3</sub> (lower display segment).

Furthermore the LCD unit adopts bus line system for data input to minimize the power consumption. In this system data input terminal of each driver LSI activated only when relevant data input is fed.

Data input for column electrodes of both the upper and the lower display segment and chip select of driver LSI are made as follows:

The driver LSI at the left end of the display face is first selected, and the adjacent driver LSI of the right side is selected when 80 dots data (20CP2) is fed. This process is sequentially continued until data is fed to the driver LSI at the right end of the display face.

This process is simultaneously followed at the column drivers LSI's of both the upper and the lower display segments. Thus data input for both the upper and the lower display must be fed through 4-bit bus line sequentially from the left end of the display face.

Since this graphic display unit contains no external RAM, it requires data and timing pulse inputs even for static display.

The timing chart of input signals are shown in Fig. 3 and Table 7.

7. Optical Characteristics

$T_A=25^{\circ}\text{C}$ ,  $V_{DD}=5.0\text{V}$ ,  $V_{EE}-V_{SS}=-18.7\text{V TYP}$

Table 8

Following spec are based upon the electrical measuring conditions, on which the contrast of perpendicular direction ( $\theta=0^{\circ}$ ) will be MAX.

Parameter	Symbol	Condition	MIN.	TYP.	MAX.	Unit	Remark
Viewing angle range	$\theta_2-\theta_1$	$\phi=0^{\circ}$ $C_o \geq 2.0$	45	-	-	dgr.	Note 1
	$\theta_1$	$\theta_1 < \theta_2$ $C_o = 2.0$	-	-	-15	dgr.	
	$\theta_2$		25	-	-	dgr.	
	$\theta_2-\theta_1$	$\phi=90^{\circ}$ $C_o \geq 2.0$	55	-	-	dgr.	
	$\theta_1$	$\theta_1 < \theta_2$ $C_o = 2.0$	-	-	-25	dgr.	
	$\theta_2$		25	-	-	dgr.	
Contrast ratio	$C_o$	$\theta=0^{\circ}$ , $\phi=0^{\circ}$	3.0	6.0	-	-	Note 2
Response time	Rise	$\tau_r$	-	120	170	ms	Note 3
	Decay	$\tau_d$	-	130	180	ms	

Note 1) The viewing angle range is defined as shorn below.

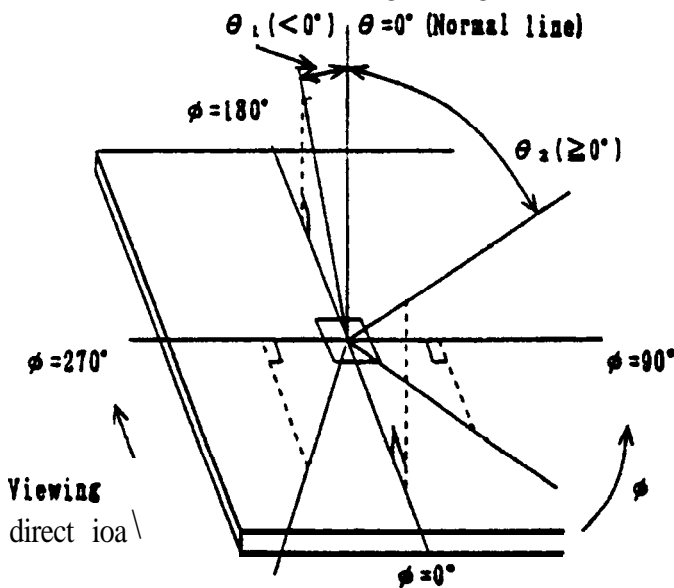

\* Angle  $\theta_1$ ,  $\theta_2$  and  $\phi$  shell fall within the range over which the displayed character can be read.

Fig. 4. Definition of Viewing Angle

Note 2) Contrast ratio is defined as follows:

Contrast ratio is calculated by using the following formula when the waveform voltage (Fig. 6) is applied in the optical chrrcteristics test method (Fig. 5).

$$C_o = \frac{\text{Photo-detector output voltage with non-select waveform being replied}}{\text{Photo-detector output voltage with select waveform being replied}}$$

Note 3) The response characteristics of photodetector output are measured as shon in tic. 6, assuming that input signals are applied so as to select and deselect the dots to be measured, in the optical characteristics test method shown in Fig. 5

Note 4) Table 8 shows the optical characteristics detected when the LCD applied voltage waveforms are in the highest frequency\*.

\* The most critical condition for the characteristics of LCD.

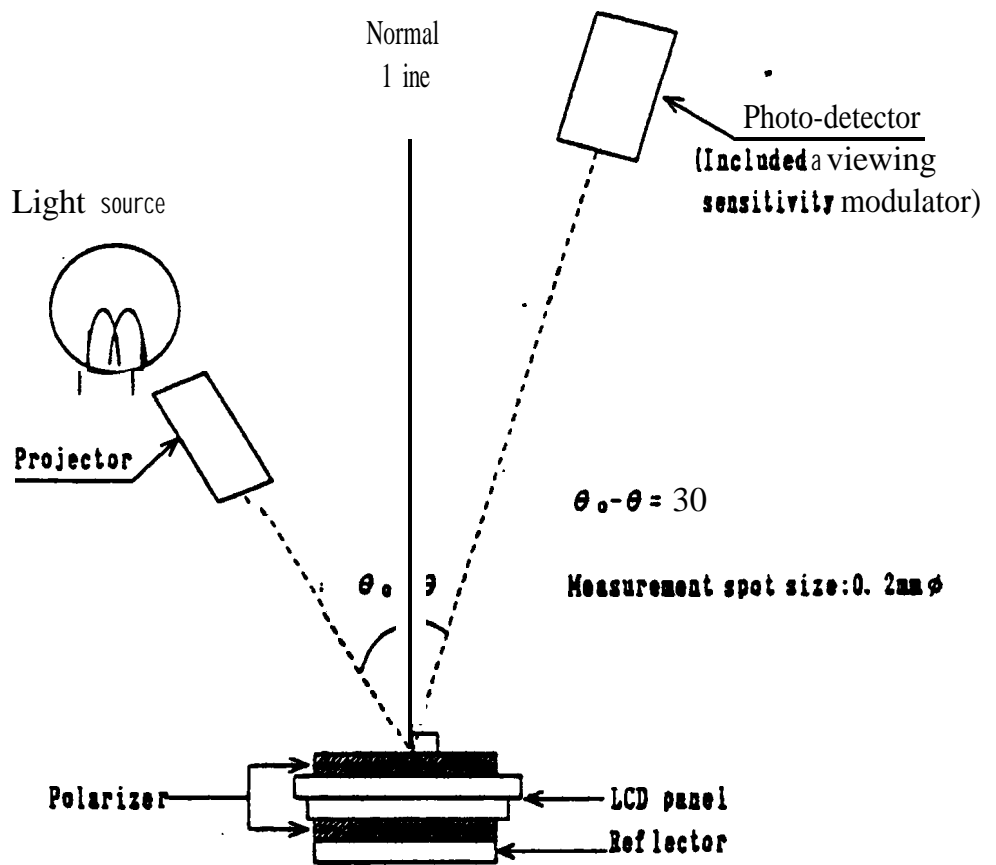

**Fig. 5. Optical Characteristics Test Method**

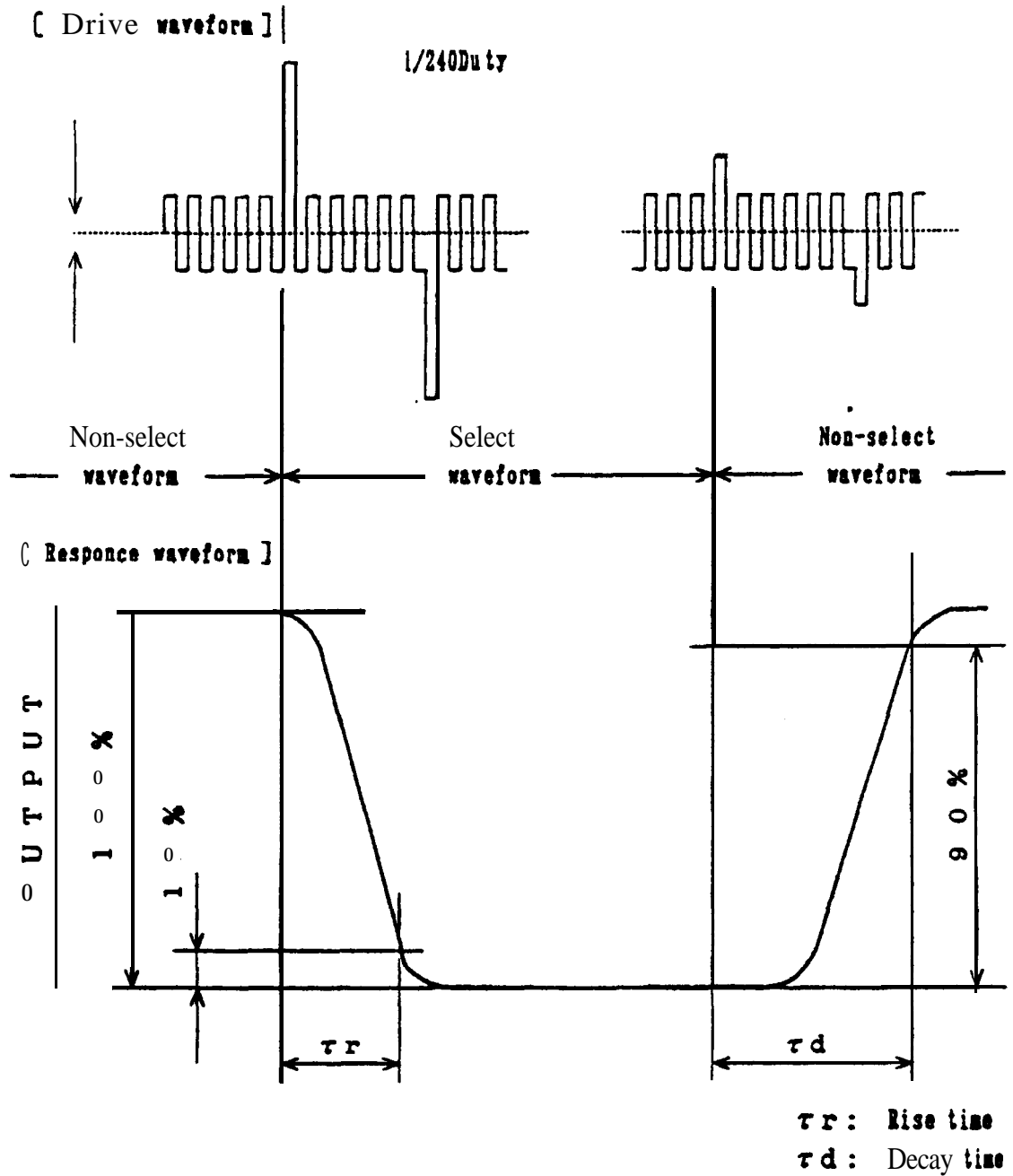
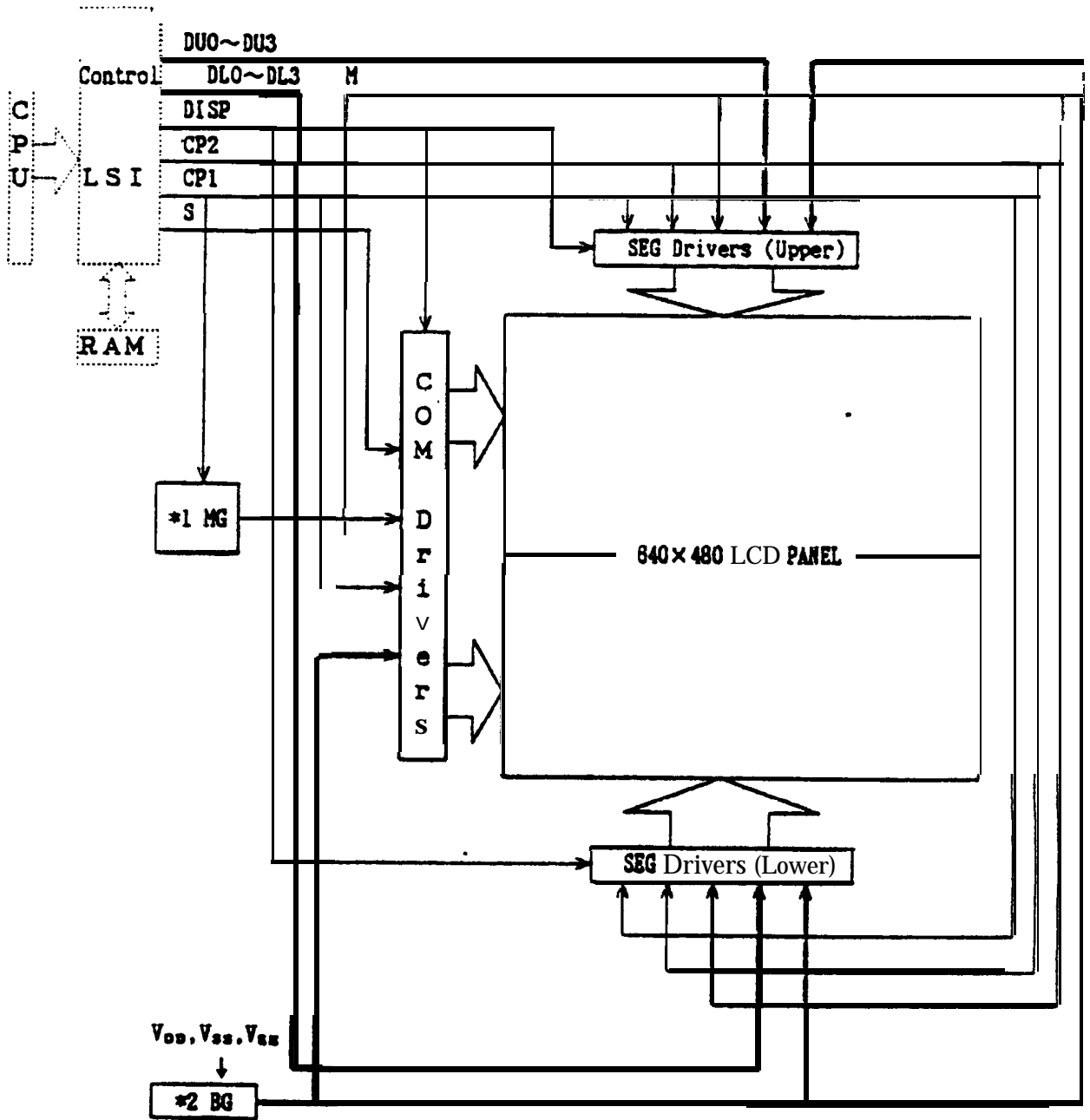

Fig.6 Definition of Response Time



\*1 MG: M GENERATOR CIRCUIT  
\*2 BG: BIAS GENERATOR CIRCUIT

Fig.7 Circuit block diagram

**SHARP**

SPEC No.  
LC92517

MODEL No.  
LM641521

PAGE  
18

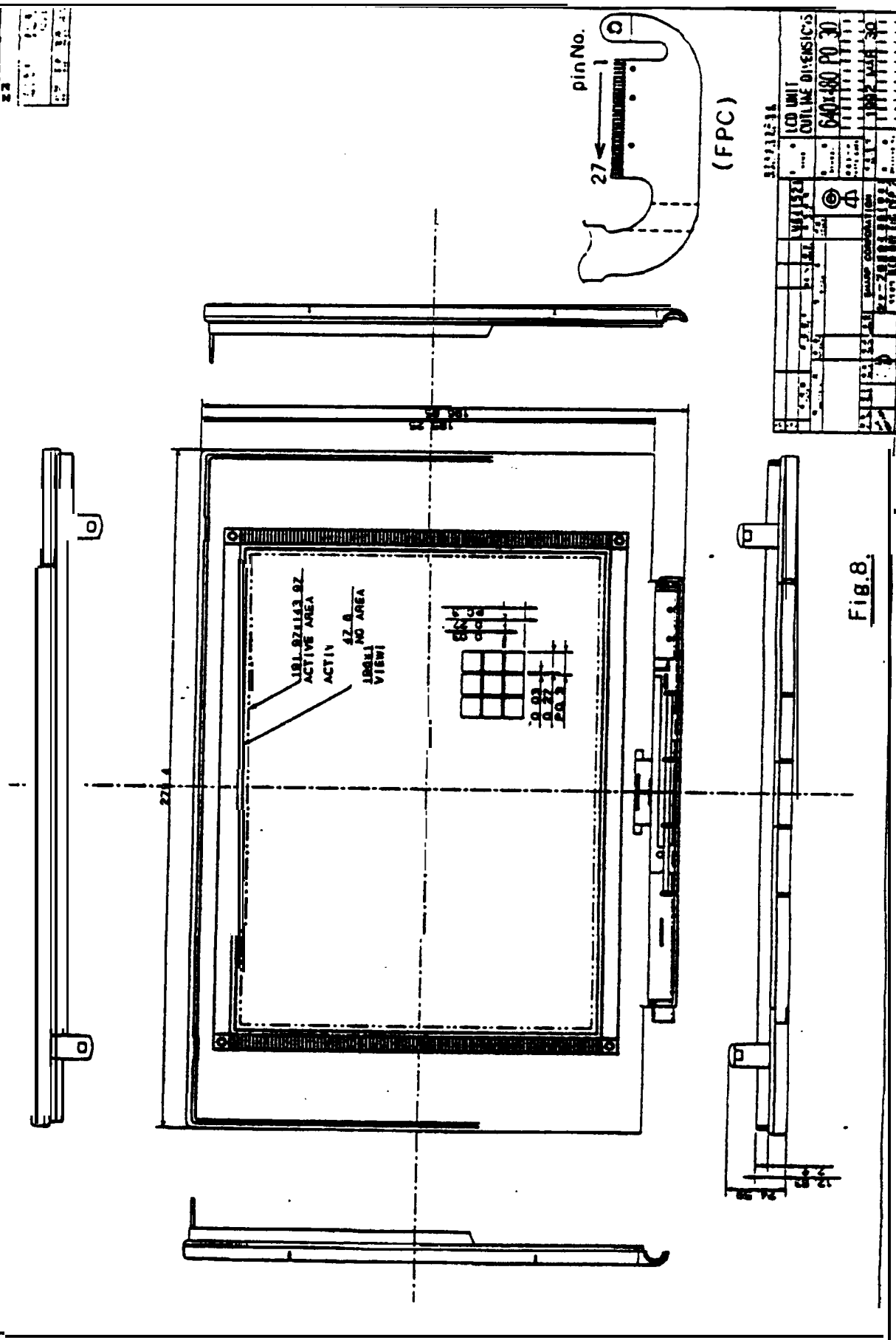

Fig. 8.

DATE	DESIGNED BY	CHECKED BY	APPROVED BY
LCD UNIT			
OUTLINE DIMENSIONS			
MODEL NO.	LM641521	PO	30
DATE			
DESIGNED BY			
CHECKED BY			
APPROVED BY			



## 8. Precautions

1) Industrial (Mechanical) design of the product in which this LCD unit will be incorporated must be so made that the viewing angle characteristics of the LCD may be optimized.

This unit's viewing angle is illustrated in Fig. 9.

$$\theta_1 < \text{viewing angle} < \theta_2 \quad (\theta_1 < 0^\circ, \theta_2 \geq 0^\circ)$$

(For the specific values of  $\theta_1, \theta_2$ , refer to the table 8.)

Please consider the optimum viewing conditions according to the purpose when installing the unit.

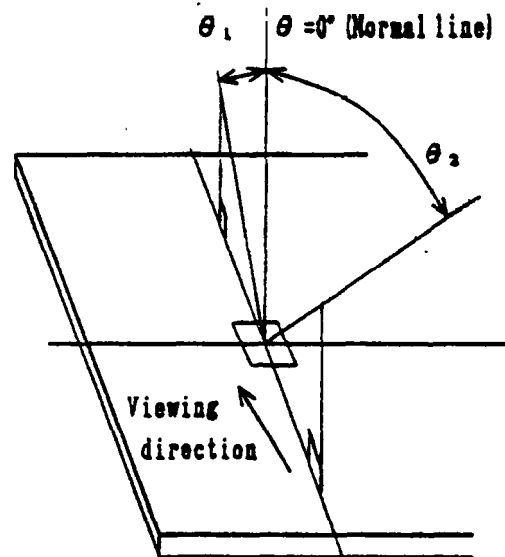

Fig. 9. Dot matrix LCD viewing angle

2) This unit is installed using mounting tabs at the four corners of PCB or bezel.

When installing the unit, pay attention and handle carefully not to allow any undue stress such as twist or bend.

A transparent acrylic resin board or other type of protective panel should be attached to the front of the unit to protect the polarizer, LCD cells, etc.

- 3) Since the front polarizer is easily damaged, please pay attention not to scratch on its face.
- 4) If the surface of the LCD ceils needs to be cleaned, wipe it swiftly with cotton or other soft cloth. If still not completely clear, blow on its and wipe.
- 5) later droplets, etc. must be wiped off immediately since they may cause color changer. staining, etc. if reuioed for a long time.
- 6) Since LCD is made of glass plates, dropping the unit or banging it against hard objects may cause cracking or fragmentation.
- 7) CMOS LSIs are equipped in this unit, so care must be taken to avoid the electro static charge, by earthing humanbody, etc. Take the following measures, to protect the unit from the electric discharge via mounting tabs from the main system the electrified with static electricity.
  - (1) Earth the retrilic case of the main system (contact of the unit and main system).
  - (2) Insulate the unit and uia system by attaching insulating rashers made of bakelite or nylon, etc.
- 8) The unit should be driven according to the specified ratings to avoid malfunction of permanent damage. DC voltage drive leads to rapid deterioration of LC, so ensure that the drive is alternating waveform by coatinoas application of the signal M. Especially the power ON/OFF sequence shorn on next page is strongly recommended to avoid latch-up of driver LSIs and application of DC voltage to LCD panel.
- 9) Avoid to expose the unit to the direct sun-light, strong ultra-violet light, etc. for a long time.
- 10) If stored at temperatures below specified storage temperature, the LC MY freeze and be deteriorated. If storage temperature exceed the specified rating, the molecular orieatatioa of the LC may change to that of a liquid, and they may not revert to their original state. As far as possible always store at normal room temperature.
- 11) Disassembling the LCD unit can cause permanent damage and should be strictly avoided.

Supply voltage sequence condition

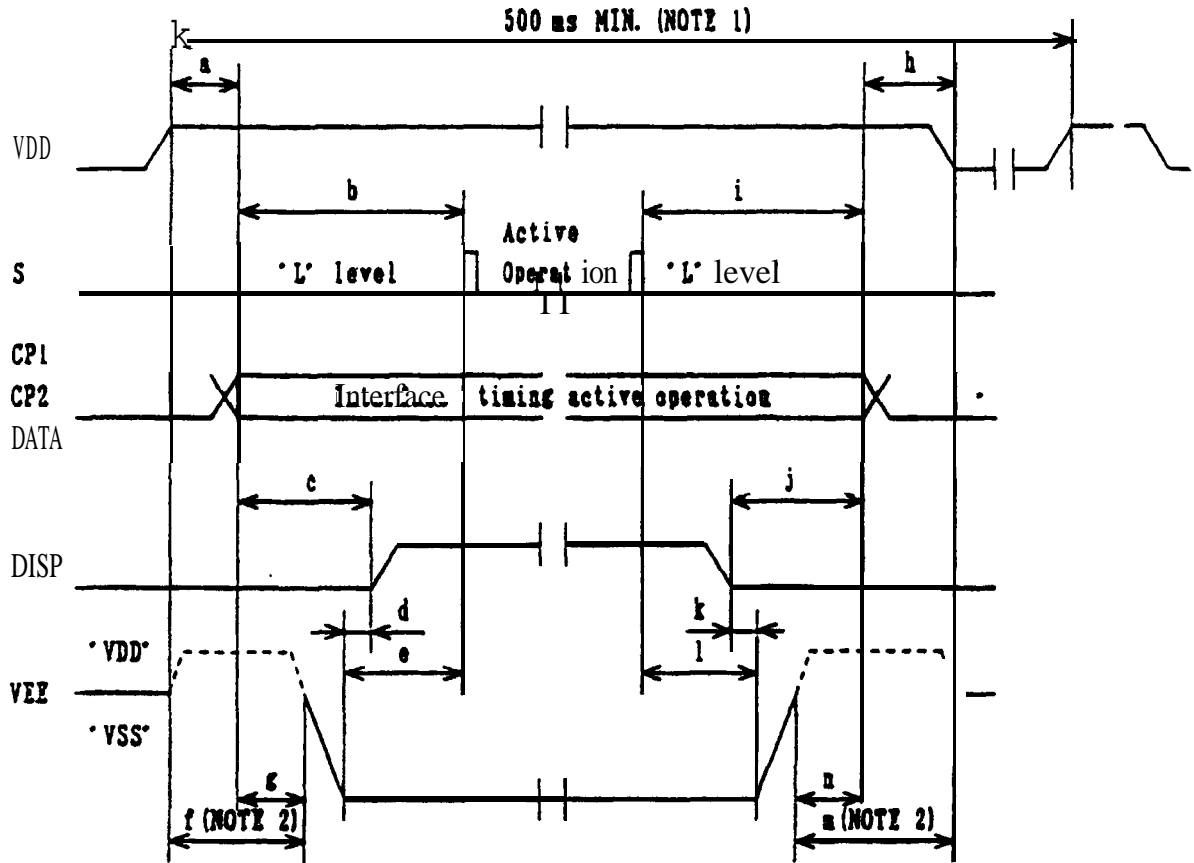

POWER ON			POWER OFF		
SYMBOL	With DISP control	Without DISP control	SYMBOL	With DISP control	Without DISP control
a	0 ms MIN.	0 ms MIN. 20 μ MAX.	h	0 ms MIN.	0 ms MIN. 20 ms MAX.
b	0 ms MIN.	20 ms MIN.	i	0 ms MIN.	20 ms MIN.
c	20 ms MIN.	-	j	20 ms MIN.	-
d	0 ms MIN.	-	k	0 ms MIN.	-
e	-	0 μ MIN.	l	-	0 ms MIN.
f	0 ms MIN.	(NOTE2)	m	0 ms MIN.	(NOTE2)
g	-	0 ms MIN. 100 ms MAX.	n	-	100 ms MIN.

(Note 1) Power ON/OFF cycle time. All signals and power line shall be in accordance with above sequence in case of power ON/OFF.

(Note 2) VEE to be set at 'VDD level' or 'open'. VEE should be in accordance with the dotted line when DISP (display control signal) is not used.

(note3) Connection of DISP (pin. No. 4)

○With DISP control  
input DISP control signal shown on page.19

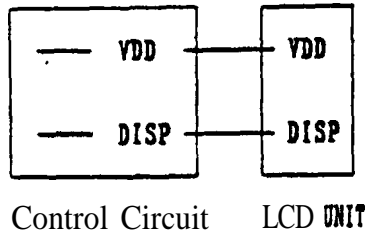

Control Circuit      LCD UNIT

○Without DISP control  
DISP to be connected with VDD.

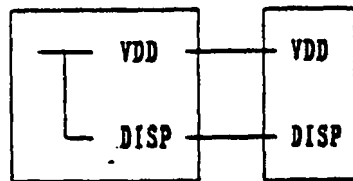

Control Circuit      LCD UNIT

9. Applicable inoocetioa standard

The LCD unit shall meet the following inspection standard  
:S-U-012-01

10. This specification describes display quality in case of no gray scale.  
Since display quality can be affected by gray scale methods, display quality shall be carefully evaluated for the usability of the LCD UNIT in case gray scale is displayed on the LCD UNIT.

**WARNING**

DON'T USE ANY MATERIALS WHICH EMIT FOLLOWING GAS FROM FRONT LCOIN (AMINEJ HARDENER) AND SILICONE ADHESIVE AGENT (DEALCOHOL OR DEOXYM) TO PREVENT CHANGE POLARIZED COLOR Owing TO GAS.