

### ■ Features :

- Protections: Short circuit / Overload / Over voltage
- Cooling by free air convection
- LED indicator for power on
- 100% full load burn-in test
- All using 105°C long life electrolytic capacitors
- Withstand 300VAC surge input for 5 second
- High operating temperature up to 70°C
- Withstand 5G vibration test
- High efficiency, long life and high reliability
- 3 years warranty



### SPECIFICATION

MODEL	RD-125A		RD-125B		
OUTPUT	OUTPUT NUMBER	CH1	CH2	CH1	CH2
	DC VOLTAGE	5V	12V	5V	24V
	RATED CURRENT	7.7A	7.7A	4.6A	4.6A
	CURRENT RANGE <small>Note.6</small>	2 ~ 15A	0.5 ~ 10A	2 ~ 10A	0.4 ~ 5A
	RATED POWER <small>Note.6</small>	130.9W		133.4W	
	RIPPLE & NOISE (max.) <small>Note.2</small>	80mVp-p	120mVp-p	80mVp-p	120mVp-p
	VOLTAGE ADJ. RANGE	CH1: 4.75 ~ 5.5V		CH1: 4.75 ~ 5.5V	
	VOLTAGE TOLERANCE <small>Note.3</small>	±5.0%	±7.0%	±5.0%	±7.0%
	LINE REGULATION <small>Note.4</small>	±1.0%	±2.0%	±1.0%	±2.0%
	LOAD REGULATION <small>Note.5</small>	±3.0%	±4.0%	±3.0%	±4.0%
	SETUP, RISE TIME	500ms, 20ms/230VAC      1200ms, 30ms/115VAC at full load			
HOLD UP TIME (Typ.)	25ms/230VAC      30ms/115VAC at full load				
INPUT	VOLTAGE RANGE	88 ~ 132VAC / 176 ~ 264VAC selected by switch		248 ~ 373VDC (Withstand 300VAC surge for 5sec. Without damage)	
	FREQUENCY RANGE	47 ~ 63Hz			
	EFFICIENCY (Typ.)	82%		85%	
	AC CURRENT (Typ.)	3A/115VAC      2A/230VAC			
	INRUSH CURRENT (Typ.)	COLD START 40A/230VAC			
LEAKAGE CURRENT	<2mA / 240VAC				
PROTECTION	OVERLOAD	110 ~ 150% rated output power Protection type : Hiccup mode, recovers automatically after fault condition is removed			
	OVER VOLTAGE	CH1: 5.75 ~ 6.75V Protection type : Hiccup mode, recovers automatically after fault condition is removed			
ENVIRONMENT	WORKING TEMP.	-25 ~ +70°C (Refer to output load derating curve)			
	WORKING HUMIDITY	20 ~ 90% RH non-condensing			
	STORAGE TEMP., HUMIDITY	-40 ~ +85°C, 10 ~ 95% RH			
	TEMP. COEFFICIENT	±0.03%/°C (0 ~ 50°C) on CH1 output			
VIBRATION	10 ~ 500Hz, 5G 10min./1cycle, period for 60min. each along X, Y, Z axes				
SAFETY & EMC <small>(Note 7)</small>	SAFETY STANDARDS	UL60950-1, TUV EN60950-1 approved			
	WITHSTAND VOLTAGE	I/P-O/P:3KVAC    I/P-FG:1.5KVAC    O/P-FG:0.5KVAC			
	ISOLATION RESISTANCE	I/P-O/P, I/P-FG, O/P-FG:100M Ohms / 500VDC / 25°C / 70% RH			
	EMI CONDUCTION & RADIATION	Compliance to EN55022 (CISPR22) Class B			
	HARMONIC CURRENT	Compliance to EN61000-3-2,-3			
EMS IMMUNITY	Compliance to EN61000-4-2,3,4,5,6,8,11; ENV50204, EN61000-6-2 (EN50082-2), heavy industry level, criteria A				
OTHERS	MTBF	232.4Khrs min.    MIL-HDBK-217F (25°C)			
	DIMENSION	199*98*38mm (L*W*H)			
	PACKING	0.7Kg; 20pcs/15Kg/0.8CUFT			
NOTE	<ol style="list-style-type: none"> <li>1. All parameters NOT specially mentioned are measured at 230VAC input, rated load and 25°C of ambient temperature.</li> <li>2. Ripple &amp; noise are measured at 20MHz of bandwidth by using a 12" twisted pair-wire terminated with a 0.1uF &amp; 47uF parallel capacitor.</li> <li>3. Tolerance : includes set up tolerance, line regulation and load regulation.</li> <li>4. Line regulation is measured from low line to high line at rated load.</li> <li>5. Load regulation is measured from 20% to 100% rated load, and other output at 60% rated load.</li> <li>6. Each output can work within current range. But total output power can't exceed rated output power.</li> <li>7. The power supply is considered a component which will be installed into a final equipment. The final equipment must be re-confirmed that it still meets EMC directives. For guidance on how to perform these EMC tests, please refer to "EMI testing of component power supplies." (as available on <a href="http://www.meanwell.com">http://www.meanwell.com</a>)</li> <li>8. Length of set up time is measured at cold first start. Turning ON/OFF the power supply very quickly may lead to increase of the set up time.</li> </ol>				

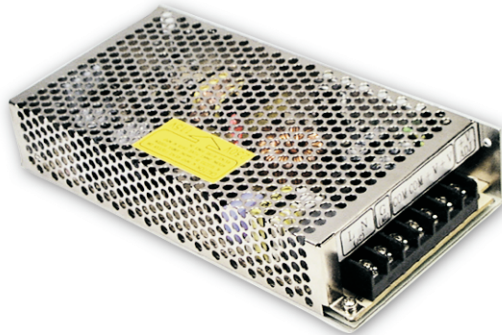

### ■ Features :

- Protections: Short circuit / Overload / Over voltage
- Cooling by free air convection
- LED indicator for power on
- 100% full load burn-in test
- All using 105°C long life electrolytic capacitors
- Withstand 300VAC surge input for 5 second
- High operating temperature up to 70°C
- Withstand 5G vibration test
- High efficiency, long life and high reliability
- 3 years warranty

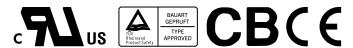

### SPECIFICATION

MODEL	RD-125-1224		RD-125-1248		RD-125-2448		
OUTPUT	OUTPUT NUMBER	CH1	CH2	CH1	CH2	CH1	CH2
	DC VOLTAGE	12V	24V	12V	48V	24V	48V
	RATED CURRENT	3.7A	3.7A	2.3A	2.3A	2A	2A
	CURRENT RANGE <small>Note.6</small>	1 ~ 7A	0.4 ~ 5A	1 ~ 7A	0.2 ~ 2.5A	0.5 ~ 4A	0.2 ~ 2.5A
	RATED POWER <small>Note.6</small>	133.2W		138W		144W	
	RIPPLE & NOISE (max.) <small>Note.2</small>	120mVp-p	200mVp-p	120mVp-p	240mVp-p	200mVp-p	240mVp-p
	VOLTAGE ADJ. RANGE	CH1: 11.4 ~ 13.2V		CH1: 11.4 ~ 13.2V		CH1: 22.8 ~ 26.4V	
	VOLTAGE TOLERANCE <small>Note.3</small>	±2.0%	+8,-5%	±2.0%	+8,-5%	±1.0%	±4.0%
	LINE REGULATION <small>Note.4</small>	±0.5%	±1.0%	±0.5%	±1.0%	±0.5%	±1.0%
	LOAD REGULATION <small>Note.5</small>	±1.0%	±5.0%	±1.0%	±5.0%	±1.0%	±3.0%
SETUP, RISE TIME	500ms, 20ms/230VAC    1200ms, 30ms/115VAC at full load						
HOLD UP TIME (Typ.)	25ms/230VAC    30ms/115VAC at full load						
INPUT	VOLTAGE RANGE	88 ~ 132VAC / 176 ~ 264VAC selected by switch		248 ~ 373VDC(Withstand 300VAC surge for 5sec. Without damage)			
	FREQUENCY RANGE	47 ~ 63Hz					
	EFFICIENCY (Typ.)	85%		86%		86%	
	AC CURRENT (Typ.)	3A/115VAC    2A/230VAC					
	INRUSH CURRENT (Typ.)	COLD START 40A/230VAC					
LEAKAGE CURRENT	<2mA / 240VAC						
PROTECTION	OVERLOAD	110 ~ 150% rated output power Protection type : Hiccup mode, recovers automatically after fault condition is removed					
	OVER VOLTAGE	CH1: 13.8 ~ 16.2V		CH1: 13.8 ~ 16.2V		CH1: 27.6 ~ 32.4V Protection type : Hiccup mode, recovers automatically after fault condition is removed	
ENVIRONMENT	WORKING TEMP.	-25 ~ +70°C (Refer to output load derating curve)					
	WORKING HUMIDITY	20 ~ 90% RH non-condensing					
	STORAGE TEMP., HUMIDITY	-40 ~ +85°C, 10 ~ 95% RH					
	TEMP. COEFFICIENT	±0.03%/°C (0 ~ 50°C) on CH1 output					
VIBRATION	10 ~ 500Hz, 5G 10min./1cycle, period for 60min. each along X, Y, Z axes						
SAFETY & EMC <small>(Note 7)</small>	SAFETY STANDARDS	UL60950-1, TUV EN60950-1 approved					
	WITHSTAND VOLTAGE	I/P-O/P:3KVAC    I/P-FG:1.5KVAC    O/P-FG:0.5KVAC					
	ISOLATION RESISTANCE	I/P-O/P, I/P-FG, O/P-FG:100M Ohms / 500VDC / 25°C / 70% RH					
	EMI CONDUCTION & RADIATION	Compliance to EN55022 (CISPR22) Class B					
	HARMONIC CURRENT	Compliance to EN61000-3-2,-3					
EMS IMMUNITY	Compliance to EN61000-4-2,3,4,5,6,8,11; ENV50204, EN61000-6-2 (EN50082-2), heavy industry level, criteria A						
OTHERS	MTBF	218.2Khrs min.    MIL-HDBK-217F (25°C)					
	DIMENSION	199*98*38mm (L*W*H)					
	PACKING	0.7Kg; 20pcs/15Kg/0.8CUFT					
NOTE	<ol style="list-style-type: none"> <li>1. All parameters NOT specially mentioned are measured at 230VAC input, rated load and 25°C of ambient temperature.</li> <li>2. Ripple &amp; noise are measured at 20MHz of bandwidth by using a 12" twisted pair-wire terminated with a 0.1uf &amp; 47uf parallel capacitor.</li> <li>3. Tolerance : includes set up tolerance, line regulation and load regulation.</li> <li>4. Line regulation is measured from low line to high line at rated load.</li> <li>5. Load regulation is measured from 20% to 100% rated load, and other output at 60% rated load.</li> <li>6. Each output can work within current range. But total output power can't exceed rated output power.</li> <li>7. The power supply is considered a component which will be installed into a final equipment. The final equipment must be re-confirmed that it still meets EMC directives. For guidance on how to perform these EMC tests, please refer to "EMI testing of component power supplies." (as available on <a href="http://www.meanwell.com">http://www.meanwell.com</a>)</li> <li>8. Length of set up time is measured at cold first start. Turning ON/OFF the power supply very quickly may lead to increase of the set up time.</li> </ol>						

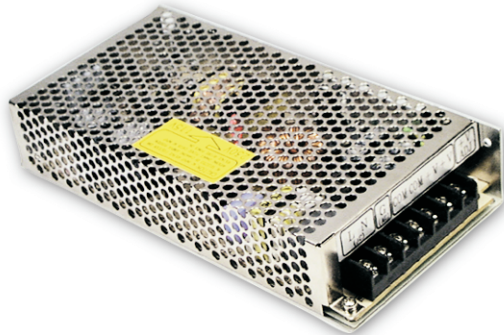

### Features :

- Protections: Short circuit/Overload/Over voltage
- Cooling by free air convection
- LED indicator for power on
- 100% full load burn-in test
- All using 105°C long life electrolytic capacitors
- Withstand 300VAC surge input for 5 second
- High operating temperature up to 70°C
- Withstand 5G vibration test
- High efficiency, long life and high reliability
- 3 years warranty

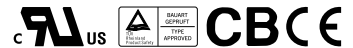

### SPECIFICATION

MODEL	RD-125-2412		RD-125-4812		RD-125-4824		
OUTPUT	OUTPUT NUMBER	CH1	CH2	CH1	CH2	CH1	CH2
	DC VOLTAGE	24V	12V	48V	12V	48V	24V
	RATED CURRENT	3.7A	3.7A	2.3A	2.3A	2A	2A
	CURRENT RANGE <small>Note.6</small>	0.5 ~ 5A	1 ~ 7A	0.3 ~ 2.5A	1 ~ 7A	0.3 ~ 2.5A	0.5 ~ 4A
	RATED POWER <small>Note.6</small>	133.2W		138W		144W	
	RIPPLE & NOISE (max.) <small>Note.2</small>	200mVp-p		240mVp-p		240mVp-p	
	VOLTAGE ADJ. RANGE	CH1: 22.8 ~ 26.4V		CH1: 45.6 ~ 52.8V		CH1: 45.6 ~ 52.8V	
	VOLTAGE TOLERANCE <small>Note.3</small>	±2.0%	±10%	±2.0%	±10%	±1.0%	±8.0%
	LINE REGULATION <small>Note.4</small>	±0.5%	±1.0%	±0.5%	±1.0%	±0.5%	±1.0%
	LOAD REGULATION <small>Note.5</small>	±1.0%	±5.0%	±1.0%	±5.0%	±1.0%	±5.0%
SETUP, RISE TIME	500ms, 20ms/230VAC    1200ms, 30ms/115VAC at full load						
HOLD UP TIME (Typ.)	25ms/230VAC    30ms/115VAC at full load						
INPUT	VOLTAGE RANGE	88 ~ 132VAC / 176 ~ 264VAC selected by switch				248 ~ 373VDC (Withstand 300VAC surge for 5sec. Without damage)	
	FREQUENCY RANGE	47 ~ 63Hz					
	EFFICIENCY (Typ.)	85%		86%		86%	
	AC CURRENT (Typ.)	3A/115VAC    2A/230VAC					
	INRUSH CURRENT (Typ.)	COLD START 40A/230VAC					
LEAKAGE CURRENT	<2mA / 240VAC						
PROTECTION	OVERLOAD	110 ~ 150% rated output power Protection type : Hiccup mode, recovers automatically after fault condition is removed					
	OVER VOLTAGE	CH1: 27.6 ~ 32.4V		CH1: 55.2 ~ 64.8V		CH1: 55.2 ~ 64.8V Protection type : Hiccup mode, recovers automatically after fault condition is removed	
ENVIRONMENT	WORKING TEMP.	-25 ~ +70°C (Refer to output load derating curve)					
	WORKING HUMIDITY	20 ~ 90% RH non-condensing					
	STORAGE TEMP., HUMIDITY	-40 ~ +85°C, 10 ~ 95% RH					
	TEMP. COEFFICIENT	±0.03%/°C (0 ~ 50°C) on CH1 output					
VIBRATION	10 ~ 500Hz, 5G 10min./1cycle, period for 60min. each along X, Y, Z axes						
SAFETY & EMC <small>(Note 7)</small>	SAFETY STANDARDS	UL60950-1, TUV EN60950-1 approved					
	WITHSTAND VOLTAGE	I/P-O/P:3KVAC    I/P-FG:1.5KVAC    O/P-FG:0.5KVAC					
	ISOLATION RESISTANCE	I/P-O/P, I/P-FG, O/P-FG:100M Ohms / 500VDC / 25°C / 70% RH					
	EMI CONDUCTION & RADIATION	Compliance to EN55022 (CISPR22) Class B					
	HARMONIC CURRENT	Compliance to EN61000-3-2,-3					
EMS IMMUNITY	Compliance to EN61000-4-2,3,4,5,6,8,11; ENV50204, EN61000-6-2 (EN50082-2), heavy industry level, criteria A						
OTHERS	MTBF	232.4Khrs min.    MIL-HDBK-217F (25°C)					
	DIMENSION	199*98*38mm (L*W*H)					
	PACKING	0.7Kg; 20pcs/15Kg/0.8CUFT					
NOTE	<ol style="list-style-type: none"> <li>1. All parameters NOT specially mentioned are measured at 230VAC input, rated load and 25°C of ambient temperature.</li> <li>2. Ripple &amp; noise are measured at 20MHz of bandwidth by using a 12" twisted pair-wire terminated with a 0.1uF &amp; 47uF parallel capacitor.</li> <li>3. Tolerance : includes set up tolerance, line regulation and load regulation.</li> <li>4. Line regulation is measured from low line to high line at rated load.</li> <li>5. Load regulation is measured from 20% to 100% rated load, and other output at 60% rated load.</li> <li>6. Each output can work within current range. But total output power can't exceed rated output power.</li> <li>7. The power supply is considered a component which will be installed into a final equipment. The final equipment must be re-confirmed that it still meets EMC directives. For guidance on how to perform these EMC tests, please refer to "EMI testing of component power supplies." (as available on <a href="http://www.meanwell.com">http://www.meanwell.com</a>)</li> <li>8. Length of set up time is measured at cold first start. Turning ON/OFF the power supply very quickly may lead to increase of the set up time.</li> </ol>						

Case No. 902A Unit:mm

**Mechanical Specification**

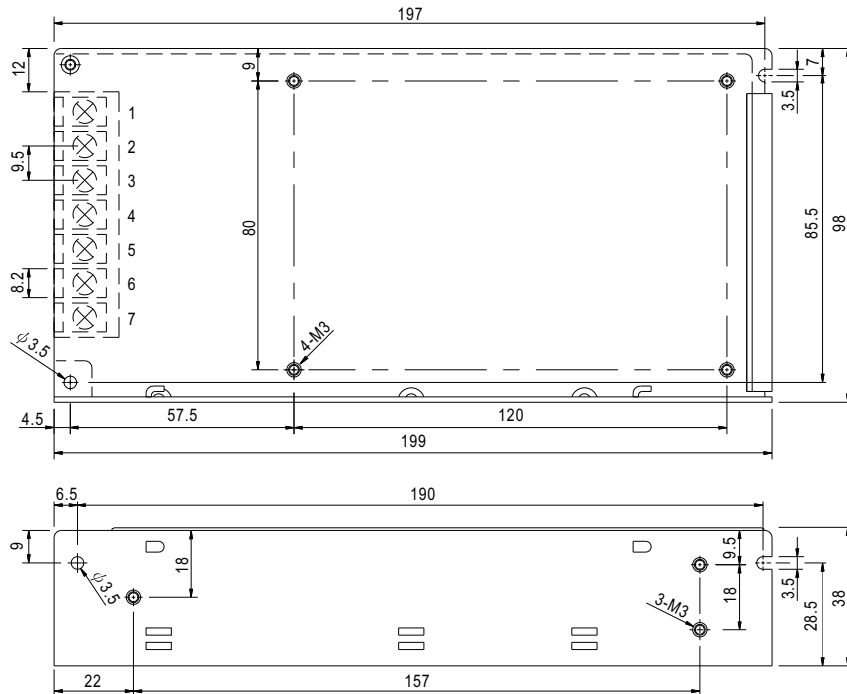

Terminal Pin No. Assignment

Pin No.	Assignment	Pin No.	Assignment
1	AC/L	4,6	DC OUTPUT COM
2	AC/N	5	DC OUTPUT +V2
3	FG $\perp$	7	DC OUTPUT +V1

**Block Diagram**

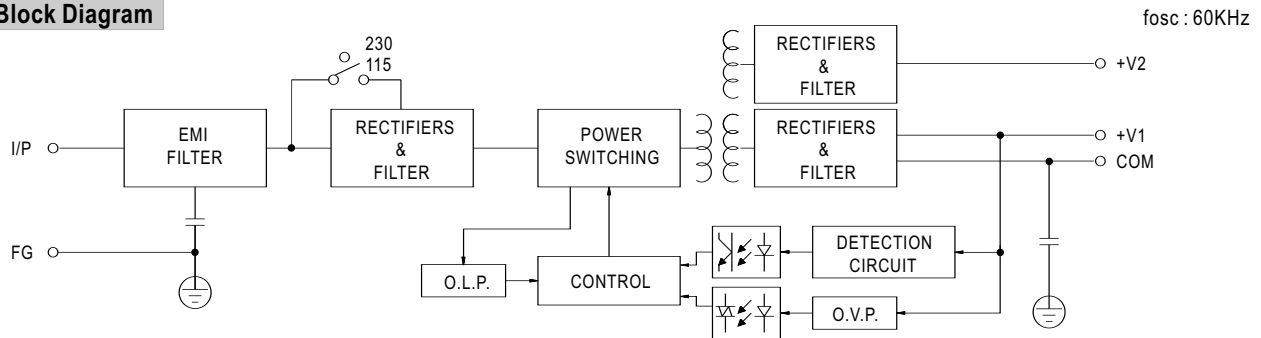

**Derating Curve**

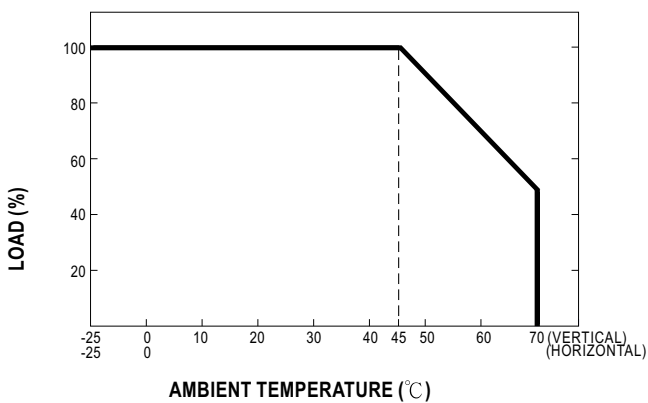

**Static Characteristics**

