



# 1700MHz to 2500MHz Variable-Gain Amplifier with Analog Gain Control

MAX2057

## General Description

The MAX2057 general-purpose, high-performance variable-gain amplifier (VGA) is designed to operate in the 1700MHz to 2500MHz frequency range\*. This device features 15.5dB of gain, 6dB of noise figure, and an output 1dB compression point of 23.8dBm. The MAX2057 also provides an exceptionally high OIP3 level of 37dBm, which is maintained over the entire attenuation range. In addition, the on-chip analog attenuators yield infinite control and high attenuation accuracy over selectable 21dB or 42dB control ranges. Each of these features makes the MAX2057 an ideal VGA for DCS/PCS, cdma2000™, W-CDMA, and PHS/PAS transmitter and power amplifier AGC circuits.

The MAX2057 is pin compatible with the MAX2056 800MHz to 1000MHz VGA, making this family of amplifiers ideal for applications where a common PC board layout is used for both frequency bands.

The MAX2057 operates from a single +5V supply and is available in a compact 36-pin thin QFN package (6mm x 6mm x 0.8mm) with an exposed paddle. Electrical performance is guaranteed over the extended -40°C to +85°C temperature range.

## Applications

DCS 1800/PCS 1900 2G and 2.5G EDGE Base-Station Transmitters and Power Amplifiers  
 cdmaOne™, cdma2000, Base-Station Transmitters and Power Amplifiers  
 UMTS/W-CDMA and Other 3G Base-Station Transmitters and Power Amplifiers  
 PHS/PAS Base-Station Transmitters and Power Amplifiers  
 Transmitter Gain Control  
 Receiver Gain Control  
 Broadband Systems  
 Automatic Test Equipment  
 Digital and Spread-Spectrum Communication Systems  
 Microwave Terrestrial Links

cdmaOne is a trademark of CDMA Development Group.  
 cdma2000 is a registered trademark of Telecommunications Industry Association.

## Features

- ◆ 1700MHz to 2500MHz RF Frequency Range\*
- ◆ 37dBm Constant OIP3 (Over All Gain Settings)
- ◆ 23.8dBm Output 1dB Compression Point
- ◆ 15.5dB Typical Gain at Maximum Gain Setting
- ◆ 0.5dB Gain Flatness Over 100MHz Bandwidth
- ◆ 6dB Noise Figure at Maximum Gain Setting (Using 1 Attenuator)
- ◆ Two Gain-Control Ranges: 21dB and 42dB
- ◆ Analog Gain Control
- ◆ Single +5V Supply Voltage
- ◆ Pin Compatible with MAX2056, 800MHz to 1000MHz RF VGA
- ◆ External Current-Setting Resistors Provide Option for Operating VGA in Reduced-Power/Reduced-Performance Mode
- ◆ Lead-Free Package Available

\*Note: Operation beyond this range is possible, but has not been characterized.

## Ordering Information

PART	TEMP RANGE	PIN-PACKAGE	PKG CODE
MAX2057ETX	-40°C to +85°C	36 Thin QFN-EP** 6mm x 6mm	T3666-2
MAX2057ETX-T	-40°C to +85°C	36 Thin QFN-EP** 6mm x 6mm	T3666-2
MAX2057ETX+D	-40°C to +85°C	36 Thin QFN-EP** 6mm x 6mm	T3666-2
MAX2057ETX+TD	-40°C to +85°C	36 Thin QFN-EP** 6mm x 6mm	T3666-2

\*\*EP = Exposed paddle.

+ = Lead (Pb) free.

D = Dry pack.

-T = Tape-and-reel package.

Pin Configuration/Functional Diagram appear at end of data sheet.

# 1700MHz to 2500MHz Variable-Gain Amplifier with Analog Gain Control

## ABSOLUTE MAXIMUM RATINGS

V <sub>CC</sub> to GND .....	-0.3V to +5.5V	θ <sub>JA</sub> (natural convection) .....	35°C/W
V <sub>CNTL</sub> to GND (with V <sub>CC</sub> applied) .....	0V to 4.75V	θ <sub>JA</sub> (1m/s airflow) .....	31°C/W
Current into V <sub>CNTL</sub> pin (V <sub>CC</sub> grounded) .....	40mA	θ <sub>JA</sub> (2.5m/s airflow) .....	29°C/W
All Other Pins to GND .....	-0.3V to (V <sub>CC</sub> + 0.3V)	θ <sub>JC</sub> (junction to exposed paddle) .....	10°C/W
RF Input Power (IN, IN_A, ATTN_OUT, OUT_A) .....	+20dBm	Operating Temperature Range .....	-40°C to +85°C
RF Input Power (AMP_IN) .....	+12dBm	Storage Temperature Range .....	-65°C to +150°C
		Junction Temperature .....	+150°C
		Lead Temperature (soldering, 10s) .....	+300°C

Stresses beyond those listed under "Absolute Maximum Ratings" may cause permanent damage to the device. These are stress ratings only, and functional operation of the device at these or any other conditions beyond those indicated in the operational sections of the specifications is not implied. Exposure to absolute maximum rating conditions for extended periods may affect device reliability.

## DC ELECTRICAL CHARACTERISTICS

(V<sub>CC</sub> = +4.75V to +5.25V, no RF signals applied, all input and output ports terminated with 50Ω, T<sub>A</sub> = -40°C to +85°C, unless otherwise noted. Typical values are at V<sub>CC</sub> = +5.0V, T<sub>A</sub> = +25°C, unless otherwise noted.)

PARAMETER	CONDITIONS	MIN	TYP	MAX	UNITS
Supply Voltage		4.75	5	5.25	V
Supply Current	R1 = 1.2kΩ, R2 = 2kΩ (Note 1)		180	230	mA
RSET1 Current	R1 = 1.2kΩ (Note 1)		1		mA
RSET2 Current	R1 = 2kΩ (Note 1)		0.6		mA
Gain-Control Voltage Range	(Note 2)	1.0		4.5	V
Gain-Control Pin Input Resistance	V <sub>CNTL</sub> = 1V to 4.5V	250	500		kΩ

## AC ELECTRICAL CHARACTERISTICS

(Typical Operating Circuit with one attenuator connected, V<sub>CC</sub> = +4.75V to +5.25V, T<sub>A</sub> = -40°C to +85°C, unless otherwise noted. Typical values are at V<sub>CC</sub> = +5.0V, R1 = 1.2kΩ, R2 = 2kΩ, P<sub>OUT</sub> = +5dBm, f<sub>IN</sub> = 2100MHz, V<sub>CNTL</sub> = 1V, 50Ω system impedance, second attenuator is not connected, T<sub>A</sub> = +25°C, unless otherwise noted.) (Note 3)

PARAMETER	CONDITIONS	MIN	TYP	MAX	UNITS
Frequency Range		1700		2500	MHz
Gain	T <sub>A</sub> = +25°C	13.5	15.5	17.5	dB
Maximum Gain Variation	T <sub>A</sub> = +25°C to -40°C	V <sub>CNTL</sub> = 1V		+0.9	dB
		V <sub>CNTL</sub> = 1.8V		+0.41	
		V <sub>CNTL</sub> = 2.6V		+0.09	
		V <sub>CNTL</sub> = 3.5V		-0.16	
	T <sub>A</sub> = +25°C to +85°C	V <sub>CNTL</sub> = 1V		-1	
		V <sub>CNTL</sub> = 1.8V		-0.56	
		V <sub>CNTL</sub> = 2.6V		-0.32	
		V <sub>CNTL</sub> = 3.5V		+0.1	
Reverse Isolation			37		dB
Noise Figure	(Note 4)		6		dB
Output 1dB Compression Point			+23.8		dBm
Output 2nd-Order Intercept Point	From maximum gain to 15dB attenuation, measured at f <sub>1</sub> + f <sub>2</sub> (Note 5)		+64		dBm
Output 3rd-Order Intercept Point	From maximum gain to 15dB attenuation (Note 5)		+37		dBm

# 1700MHz to 2500MHz Variable-Gain Amplifier with Analog Gain Control

MAX2057

## AC ELECTRICAL CHARACTERISTICS (continued)

(Typical Operating Circuit with one attenuator connected,  $V_{CC} = +4.75V$  to  $+5.25V$ ,  $T_A = -40^{\circ}C$  to  $+85^{\circ}C$ , unless otherwise noted. Typical values are at  $V_{CC} = +5.0V$ ,  $R_1 = 1.2k\Omega$ ,  $R_2 = 2k\Omega$ ,  $P_{OUT} = +5dBm$ ,  $f_{IN} = 2100MHz$ ,  $V_{CNTL} = 1V$ ,  $50\Omega$  system impedance, second attenuator is not connected,  $T_A = +25^{\circ}C$ , unless otherwise noted.) (Note 3)

PARAMETER	CONDITIONS	MIN	TYP	MAX	UNITS
Output 3rd-Order Intercept Point Variation Over Temperature	$T_A = +25^{\circ}C$ to $+85^{\circ}C$		-0.83		dB
	$T_A = +25^{\circ}C$ to $-40^{\circ}C$		-0.6		
2nd Harmonic	From maximum gain to 15dB attenuation, $P_{OUT} = +5dBm$		-65		dBc
3rd Harmonic	From maximum gain to 15dB attenuation, $P_{OUT} = +5dBm$		-83		dBc
RF Gain-Control Range	$f_{RF} = 1.7GHz$ to $2.2GHz$ , $V_{CNTL} = 1V$ to $4.5V$	One attenuator	17	20.7	dB
		Two attenuators	34	42.4	
RF Gain-Control Slope	$V_{CNTL} = 1.8V$ to $3.5V$		-10		dB/V
Maximum RF Gain-Control Slope	Maximum slope vs. gain-control voltage		-15.2		dB/V
Gain Flatness Over 100MHz Bandwidth	Peak-to-peak for all settings		0.5		dB
Attenuator Switching Time	15dB attenuation change (Note 6)		500		ns
Attenuator Insertion Loss	Second attenuator (IN_A, OUT_A)		2.2		dB
Input Return Loss	Entire band, all gain settings		18		dB
Output Return Loss	Entire band, all gain settings		15		dB
Group Delay	Input/output $50\Omega$ lines de-embedded		300		ps
Group Delay Flatness Over 100MHz Bandwidth	Peak to peak		20		ps
Group Delay Change vs. Gain Control	$V_{CNTL} = 1V$ to $4V$		-70		ps
Insertion Phase Change vs. Gain Control	$V_{CNTL} = 1V$ to $4V$		50		degrees

**Note 1:** Total supply current reduces as  $R_1$  and  $R_2$  are increased.

**Note 2:** Operating outside this range for extended periods may affect device reliability. Limit pin input current to 40mA when  $V_{CC}$  is not present.

**Note 3:** All limits include external component losses, unless otherwise noted.

**Note 4:** Noise figure increases by approximately 1dB for every 1dB of gain reduction.

**Note 5:**  $f_1 = 2100MHz$ ,  $f_2 = 2101MHz$ ,  $+5dBm$ /tone at OUT.

**Note 6:** Switching time is measured from 50% of the control signal to when the RF output settles to  $\pm 1dB$ .

# 1700MHz to 2500MHz Variable-Gain Amplifier with Analog Gain Control

## Typical Operating Characteristics

### One Attenuator Configuration

(Typical Application Circuit with **one attenuator** connected,  $V_{CC} = +5.0V$ ,  $R1 = 1.2k\Omega$ ,  $R2 = 2k\Omega$ ,  $f_{IN} = 2100MHz$ , maximum gain setting,  $P_{OUT} = +5dBm$ , linearity measured at  $P_{OUT} = +5dBm/$ tone,  $T_A = +25^\circ C$ , unless otherwise noted.)

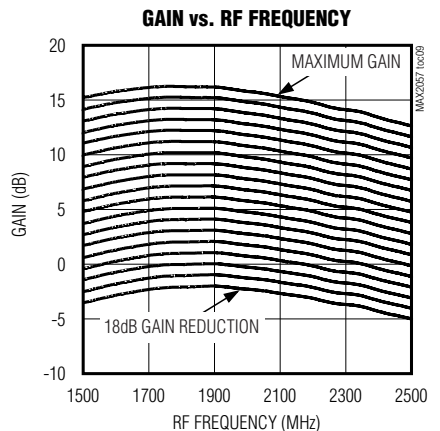
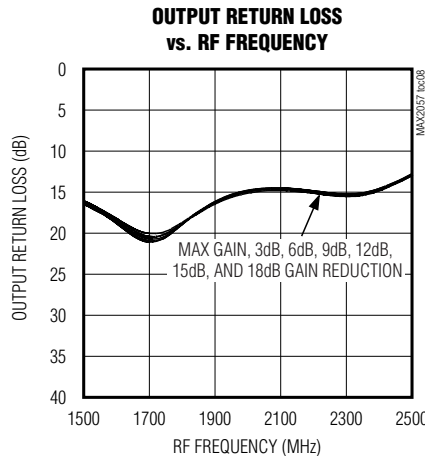
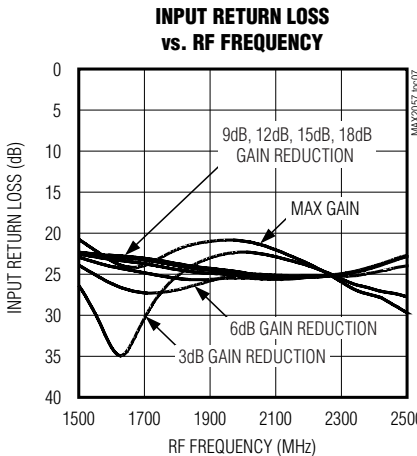
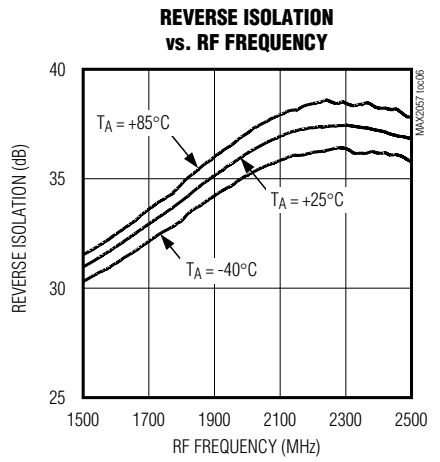
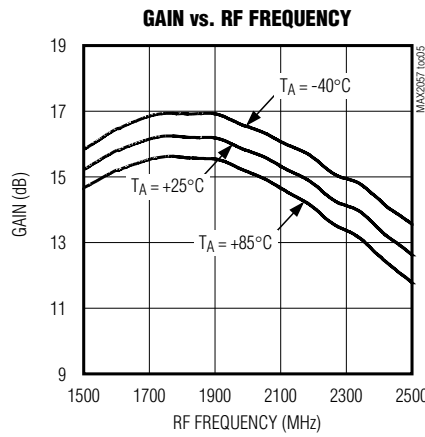
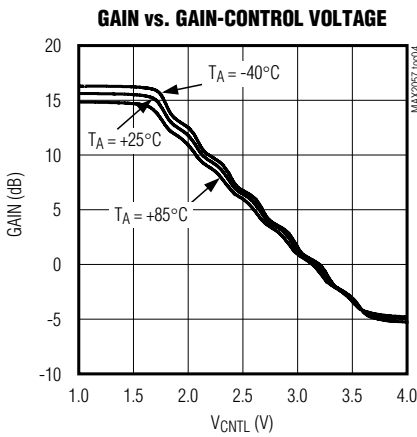
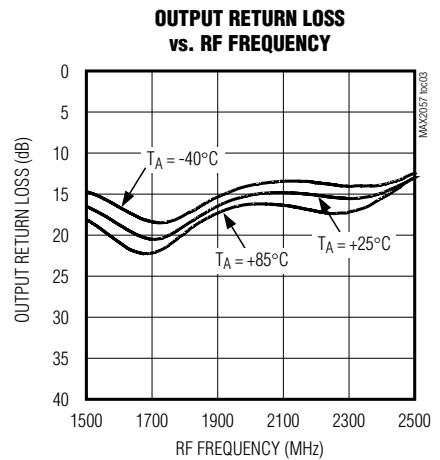
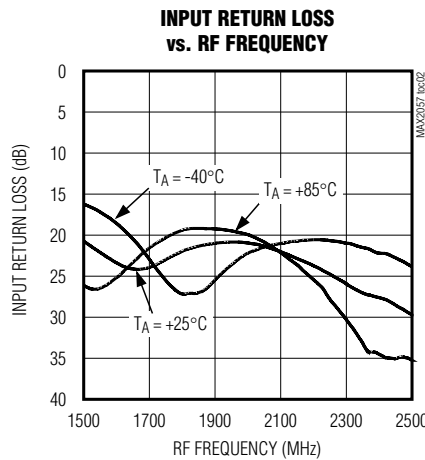
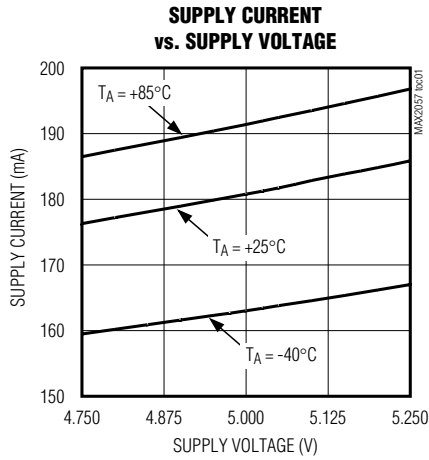

# 1700MHz to 2500MHz Variable-Gain Amplifier with Analog Gain Control

MAX2057

## Typical Operating Characteristics (continued)

### One Attenuator Configuration

(Typical Application Circuit with **one attenuator** connected,  $V_{CC} = +5.0V$ ,  $R_1 = 1.2k\Omega$ ,  $R_2 = 2k\Omega$ ,  $f_{IN} = 2100MHz$ , maximum gain setting,  $P_{OUT} = +5dBm$ , linearity measured at  $P_{OUT} = +5dBm/$ tone,  $T_A = +25^\circ C$ , unless otherwise noted.)

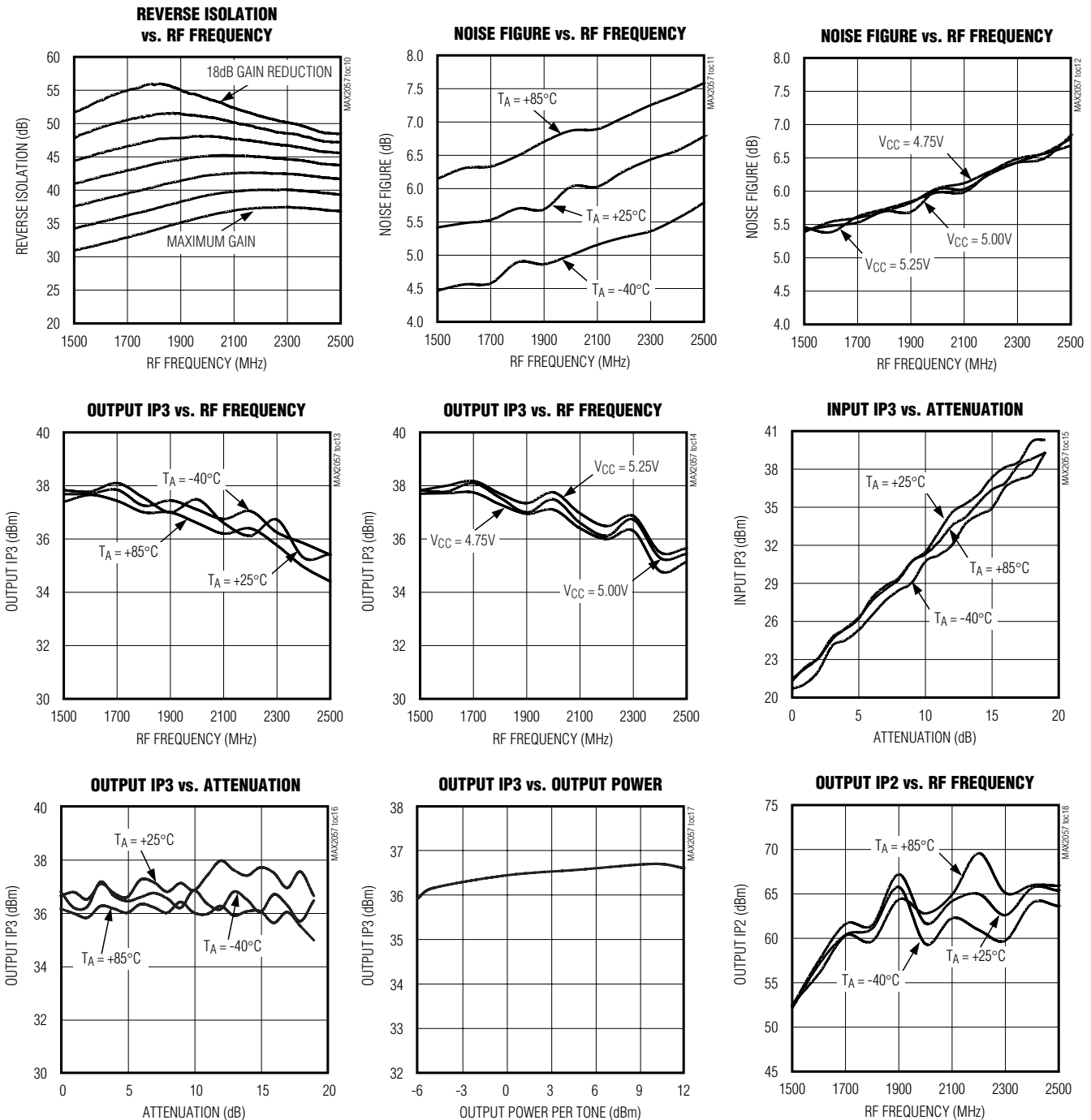

# 1700MHz to 2500MHz Variable-Gain Amplifier with Analog Gain Control

## Typical Operating Characteristics (continued)

### One Attenuator Configuration

(Typical Application Circuit with **one attenuator** connected,  $V_{CC} = +5.0V$ ,  $R1 = 1.2k\Omega$ ,  $R2 = 2k\Omega$ ,  $f_{IN} = 2100MHz$ , maximum gain setting,  $P_{OUT} = +5dBm$ , linearity measured at  $P_{OUT} = +5dBm/$ tone,  $T_A = +25^\circ C$ , unless otherwise noted.)

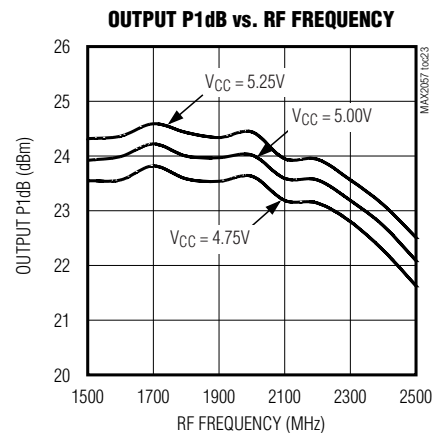
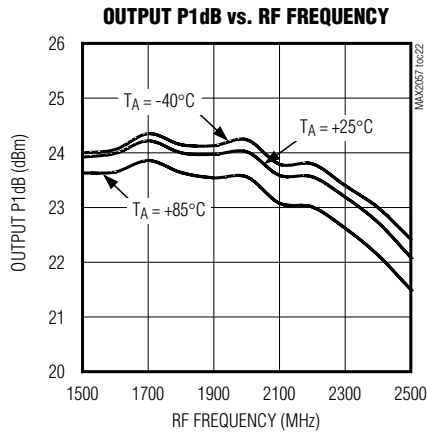
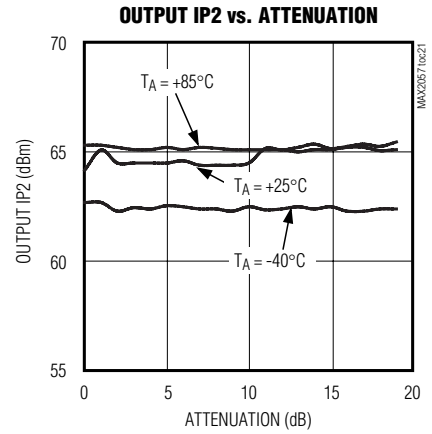
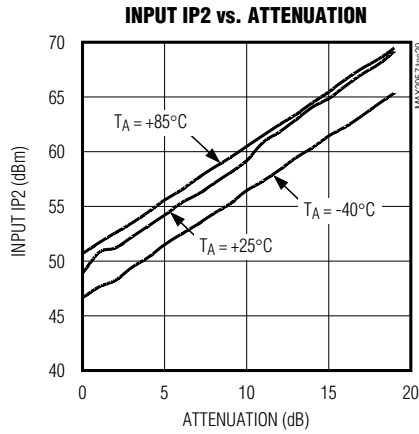
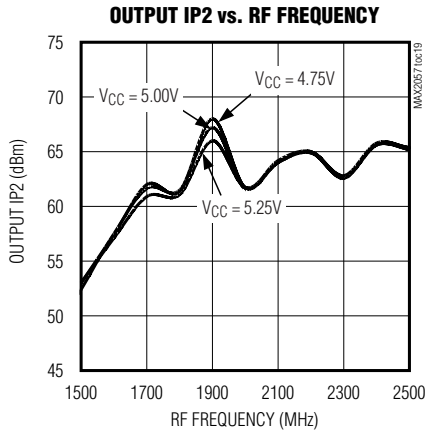

# 1700MHz to 2500MHz Variable-Gain Amplifier with Analog Gain Control

MAX2057

## Typical Operating Characteristics

### Two Attenuator Configuration

(Typical Application Circuit with **two attenuators** connected,  $V_{CC} = +5.0V$ ,  $R1 = 1.2k\Omega$ ,  $R2 = 2k\Omega$ ,  $f_{IN} = 2100MHz$ , maximum gain setting,  $P_{OUT} = +5dBm$ , linearity measured at  $P_{OUT} = +5dBm/$ tone,  $T_A = +25^\circ C$ , unless otherwise noted.)

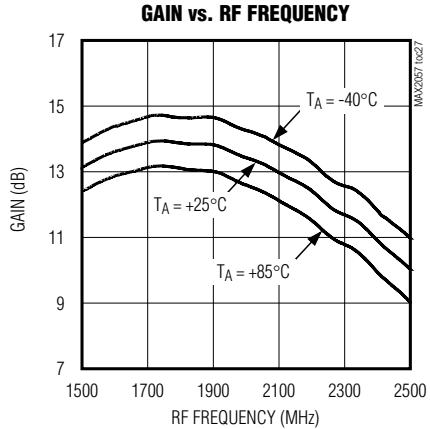
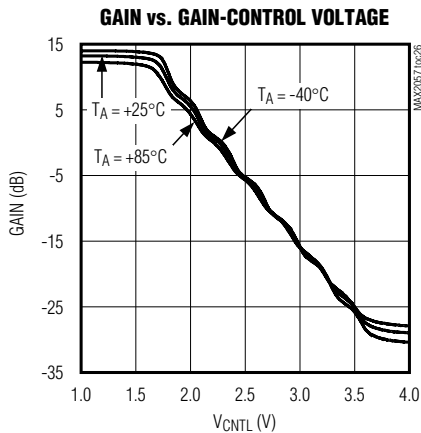
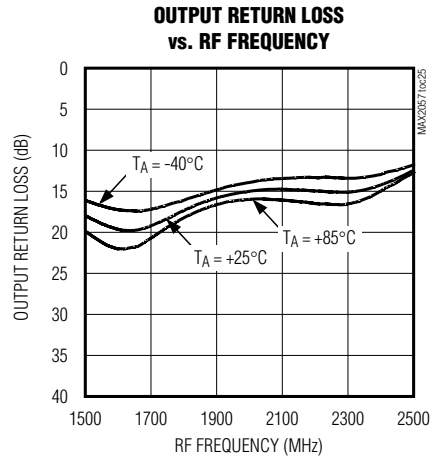
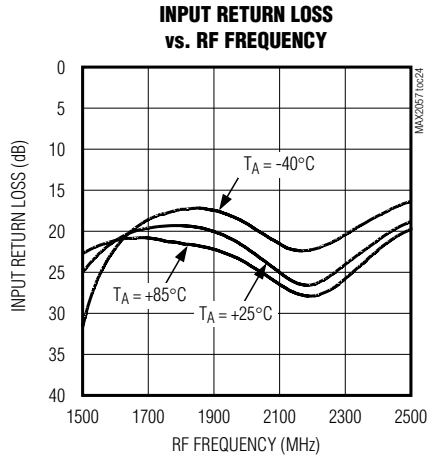

# 1700MHz to 2500MHz Variable-Gain Amplifier with Analog Gain Control

## Typical Operating Characteristics (continued)

### Two Attenuator Configuration

(Typical Application Circuit with **two attenuators** connected,  $V_{CC} = +5.0V$ ,  $R1 = 1.2k\Omega$ ,  $R2 = 2k\Omega$ ,  $f_{IN} = 2100MHz$ , maximum gain setting,  $P_{OUT} = +5dBm$ , linearity measured at  $P_{OUT} = +5dBm$ /tone,  $T_A = +25^\circ C$ , unless otherwise noted.)

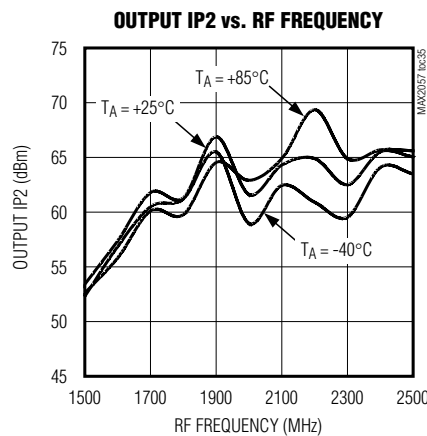
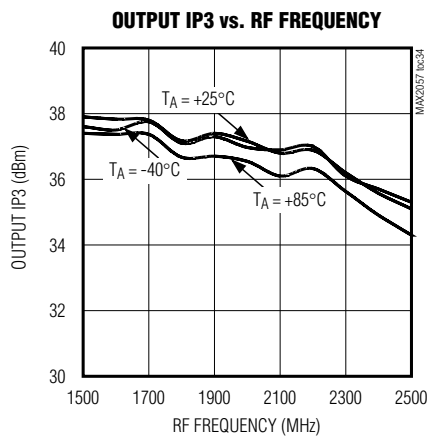
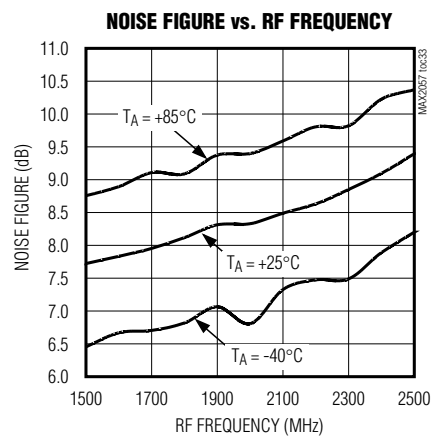
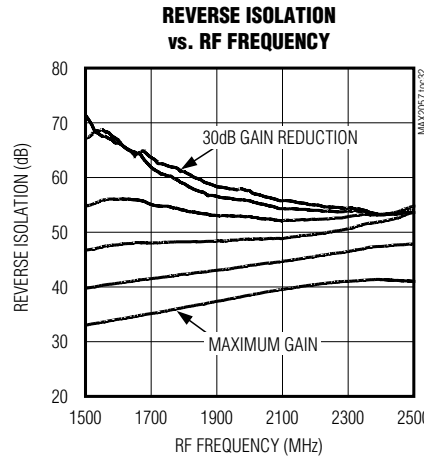
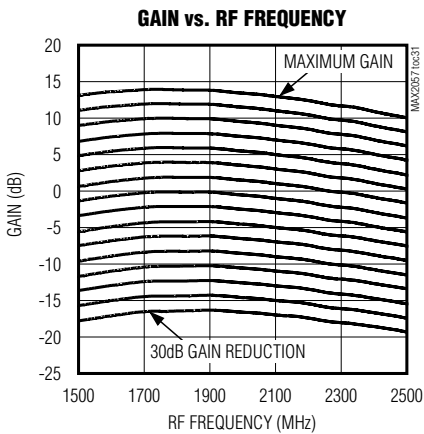
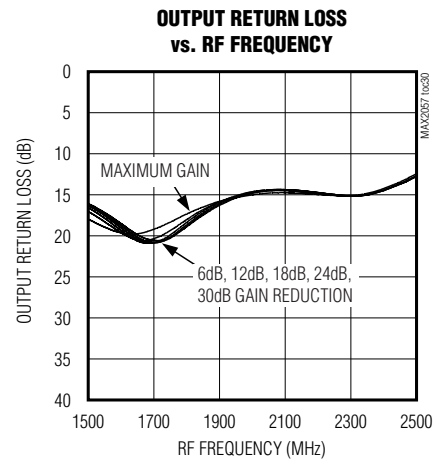
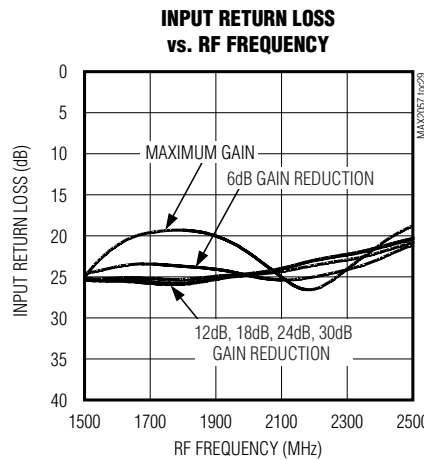
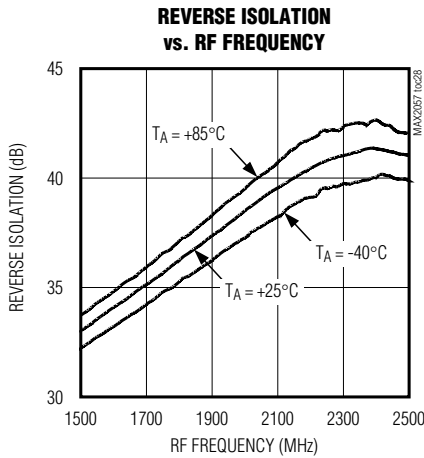



# 1700MHz to 2500MHz Variable-Gain Amplifier with Analog Gain Control

## Pin Description

MAX2057

PIN	NAME	FUNCTION
1, 3, 4, 6, 7, 9, 10, 12, 14, 18, 19, 21–24, 27, 28, 30, 31, 33, 34, 36	GND	Ground. Connect to the board's ground plane using low-inductance layout techniques.
2	OUT_A	Second-Attenuator Output. Internally matched to 50Ω over the operating frequency band. Connect to IN through a DC-blocking capacitor if greater than 21dB of gain-control range is required. No connection is required if the second attenuator is not used.
5, 13, 16, 25, 32	VCC	Power Supply. Bypass each pin to GND with capacitors as shown in the <i>Typical Application Circuit</i> . Place capacitors as close to the pin as possible.
8	IN_A	Second-Attenuator Input. Internally matched to 50Ω over the operating frequency band. Connect to a 50Ω RF source through a DC-blocking capacitor if greater than 21dB of gain-control range is required. No connection is required if the second attenuator is not used.
11	VCNTL	Analog Gain-Control Input. <b>Limit voltages applied to this pin to a 1V to 4.5V range when Vcc is present to ensure device reliability.</b>
15	RSET1	First-Stage Amplifier Bias-Current Setting. Connect to GND through a 1.2kΩ resistor.
17	RSET2	Second-Stage Amplifier Bias-Current Setting. Connect to GND through a 2kΩ resistor.
20	OUT	RF Output. Internally matched to 50Ω over the operating frequency band. Requires a DC-blocking capacitor and a shunt-matching capacitor.
26	AMP_IN	Amplifier Input. Internally matched to 50Ω over the operating frequency band. Connect to ATTN_OUT through a DC-blocking capacitor.
29	ATTN_OUT	Attenuator Output. Internally matched to 50Ω over the operating frequency band. Connect to AMP_IN through a DC-blocking capacitor.
35	IN	RF Input. Internally matched to 50Ω over the operating frequency band. Connect to a 50Ω RF source through a DC-blocking capacitor if the second attenuator is not used.
Exposed Paddle	GND	Exposed Paddle Ground Plane. This paddle affects RF performance and provides heat dissipation. This paddle <b>MUST</b> be soldered evenly to the board's ground plane for proper operation.

# 1700MHz to 2500MHz Variable-Gain Amplifier with Analog Gain Control

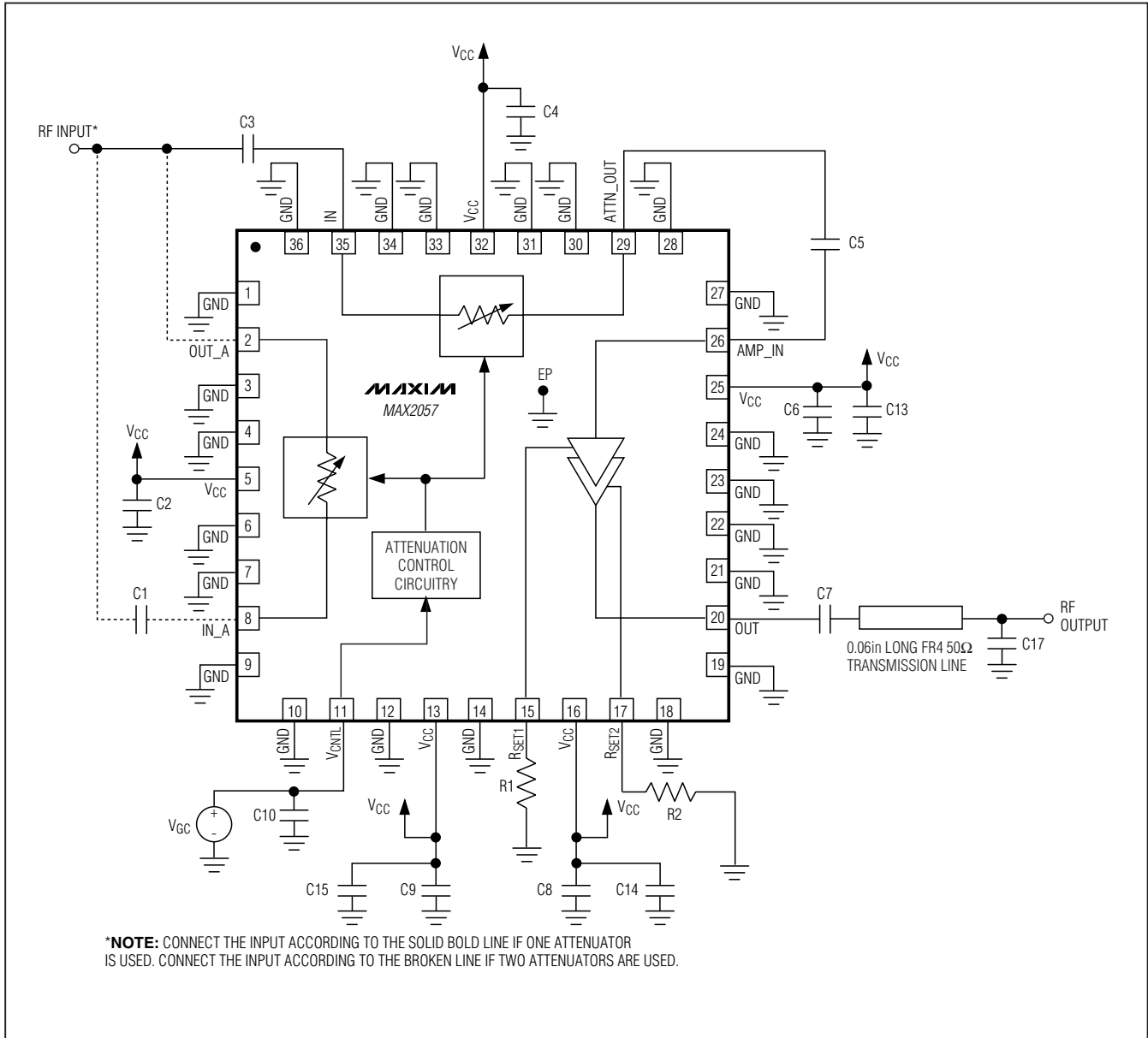

Figure 1. Typical Application Circuit

## Detailed Description

The MAX2057 general-purpose, high-performance VGA with analog gain control is designed to interface with 50Ω systems operating in the 1700MHz to 2500MHz frequency range.

The MAX2057 integrates two attenuators to provide 21dB or 42dB of precision analog gain control, as well

as a two-stage amplifier that has been optimized to provide high gain, high IP3, low noise figure, and low power consumption. The bias current of each amplifier stage can be adjusted by individual external resistors to further reduce power consumption for applications that do not require high linearity.

# 1700MHz to 2500MHz Variable-Gain Amplifier with Analog Gain Control

**Table 1. Typical Application Circuit Component Values**

DESIGNATION	VALUE	TYPE
C1, C3, C5, C7, C10	22pF	Microwave capacitors (0402)
C2, C4, C6, C8, C9	1000pF	Microwave capacitors (0402)
C13, C14, C15	0.1 $\mu$ F	Microwave capacitors (0603)
C17	0.75pF	Microwave capacitor (0402)
R1	1.2k $\Omega$	$\pm$ 1% resistor (0402)
R2	2k $\Omega$	$\pm$ 1% resistor (0402)

## Applications Information

### Analog Attenuation Control

A single input voltage at the  $V_{CNTL}$  pin adjusts the gain of the MAX2057. Up to 21dB of gain-control range is provided through a single attenuator. At the maximum gain setting, each attenuator's insertion loss is approximately 2.2dB. With the single attenuator at the maximum gain setting, the device provides a nominal 15.5dB of cascaded gain and 6dB of cascaded noise figure.

If a larger gain-control range is desired, a second on-chip attenuator can be connected in the signal path to provide an additional 21dB of gain-control range. With the second attenuator connected at the maximum gain setting, the device typically exhibits 13.3dB of cascaded gain. Note that the  $V_{CNTL}$  pin simultaneously adjusts both on-chip attenuators.

The  $V_{CNTL}$  input voltage drives a high-impedance load (>250k $\Omega$ ). It is suggested that a current-limiting resistor be included in series with this connection to limit the input current to less than 40mA should the control voltage be applied when  $V_{CC}$  is not present. A series resistor of greater than 200 $\Omega$  will provide complete protection for 5V control voltage ranges. **Limit  $V_{CNTL}$  input voltages to a 1.0V to 4.5V range when  $V_{CC}$  is present to ensure the reliability of the device.**

### Amplifier Bias Current

The MAX2057 integrates a two-stage amplifier to simultaneously provide high gain and high IP3. Optimal performance is obtained when R1 and R2 are equal to 1.2k $\Omega$  and 2k $\Omega$ , respectively. The typical supply current is 180mA and the typical output IP3 is 37dBm under these conditions.

Increasing R1 and R2 from the nominal values of 1.2k $\Omega$  and 2k $\Omega$  reduces the bias current of each amplifier stage, which reduces the total power consumption and IP3 of the device. This feature can be utilized to further decrease power consumption for applications that do not require high IP3.

### Layout Considerations

A properly designed PC board is an essential part of any RF/microwave circuit. Keep RF signal lines as short as possible to reduce losses, radiation, and inductance. For best performance, route the ground-pin traces directly to the exposed pad underneath the package. This pad **MUST** be connected to the ground plane of the board by using multiple vias under the device to provide the best RF and thermal conduction path. Solder the exposed pad on the bottom of the device package to a PC board exposed pad.

### Power-Supply Bypassing

Proper voltage-supply bypassing is essential for high-frequency circuit stability. Bypass each VCC pin with capacitors placed as close to the device as possible. Place the smallest capacitor closest to the device. Refer to the MAX2057 evaluation kit data sheet for more details.

### Exposed Paddle RF and Thermal Considerations

The EP of the MAX2057's 36-pin thin QFN-EP package provides a low-thermal-resistance path to the die. It is important that the PC board on which the IC is mounted be designed to conduct heat from this contact. In addition, the EP provides a low-inductance RF ground path for the device.

The EP **MUST** be soldered to a ground plane on the PC board either directly or through an array of plated via holes. Soldering the pad to ground is also critical for efficient heat transfer. Use a solid ground plane wherever possible.

# 1700MHz to 2500MHz Variable-Gain Amplifier with Analog Gain Control

## Pin Configuration/ Functional Diagram

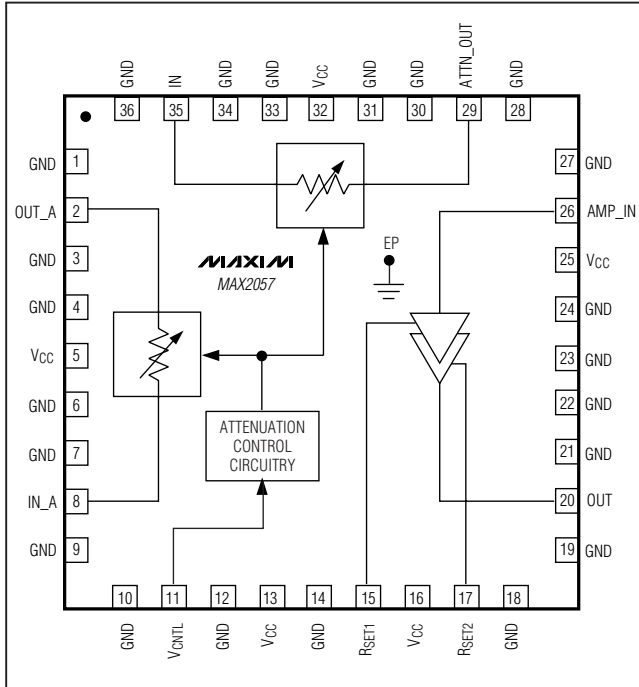

## Chip Information

TRANSISTOR COUNT: 5191  
PROCESS: BICMOS

## Package Information

For the latest package outline information, go to [www.maxim-ic.com/packages](http://www.maxim-ic.com/packages).

Maxim cannot assume responsibility for use of any circuitry other than circuitry entirely embodied in a Maxim product. No circuit patent licenses are implied. Maxim reserves the right to change the circuitry and specifications without notice at any time.

12 **Maxim Integrated Products, 120 San Gabriel Drive, Sunnyvale, CA 94086 408-737-7600**