

SONY**CXA1343M/N****Low Power FM IF Amplifier****Description**

CXA1343M/N are single-chip ICs for FM Radio such as CELLULAR mobile, etc...

Features

- It includes the all the functions needed to the cellular mobile such as second mixer, FM detecting circuit, RSSI (Received Signal Strength Indicator) etc...
- Built in gain adjustable AF amplifier and built in RSSI output buffer for low impedance output. (AF out 3.0V MAX, RSSI output imp. $\approx 100 \Omega$)
- It has wide operating voltage (4.5 to 9.5V) and low current consumption. ($I_{cc} = 5.7\text{mA}$ typ., at $V_{cc} = 5\text{V}$)
- It has wide RSSI range and excellent temperature characteristics.
- Very small package 24 pin SOP/VSOP

Functions

- Second mixer and oscillator
- IF amplifier and limiter
- RSSI output buffer
- FM detecting circuit
- Gain adjustable AF amplifier

Structure

Bipolar silicon monolithic IC

Package Outline

Unit : mm

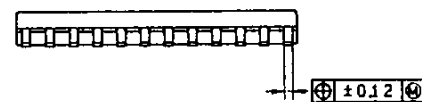
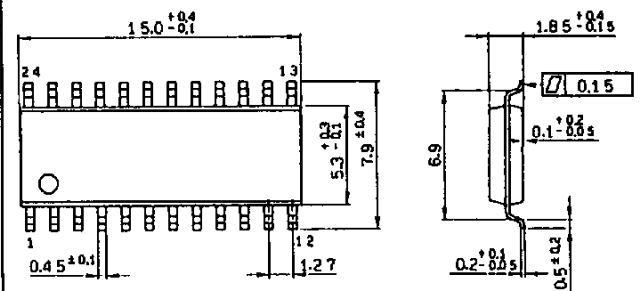
CXA1343M 24 pin SOP (Plastic)

SOP - 24P - L01

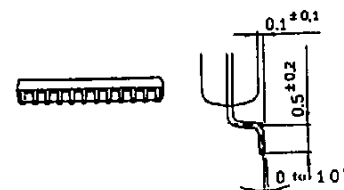
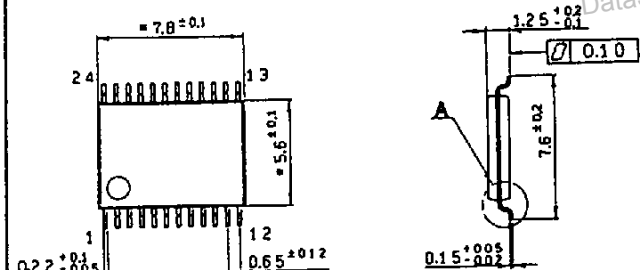
CXA1343N 24 pin VSOP (Plastic)

VSOP 24P L01

Absolute Maximum Ratings (Ta = 25°C)

• Supply voltage	V_{cc}	17	V
• Operating temperature	T_{opr}	-35 to +85	°C
• Storage temperature	T_{stg}	-65 to +150	°C
• Allowable power dissipation	P_D	780	mW (CXA1343M)
		500	mW (CXA1343N)

Recommended Operating Condition

• Supply voltage	V_{cc}	4.5 to 9.5	V
------------------	----------	------------	---

www.DataSheet4U.com

E89202 - ST

Block Diagram and Pin Configuration (Top View)

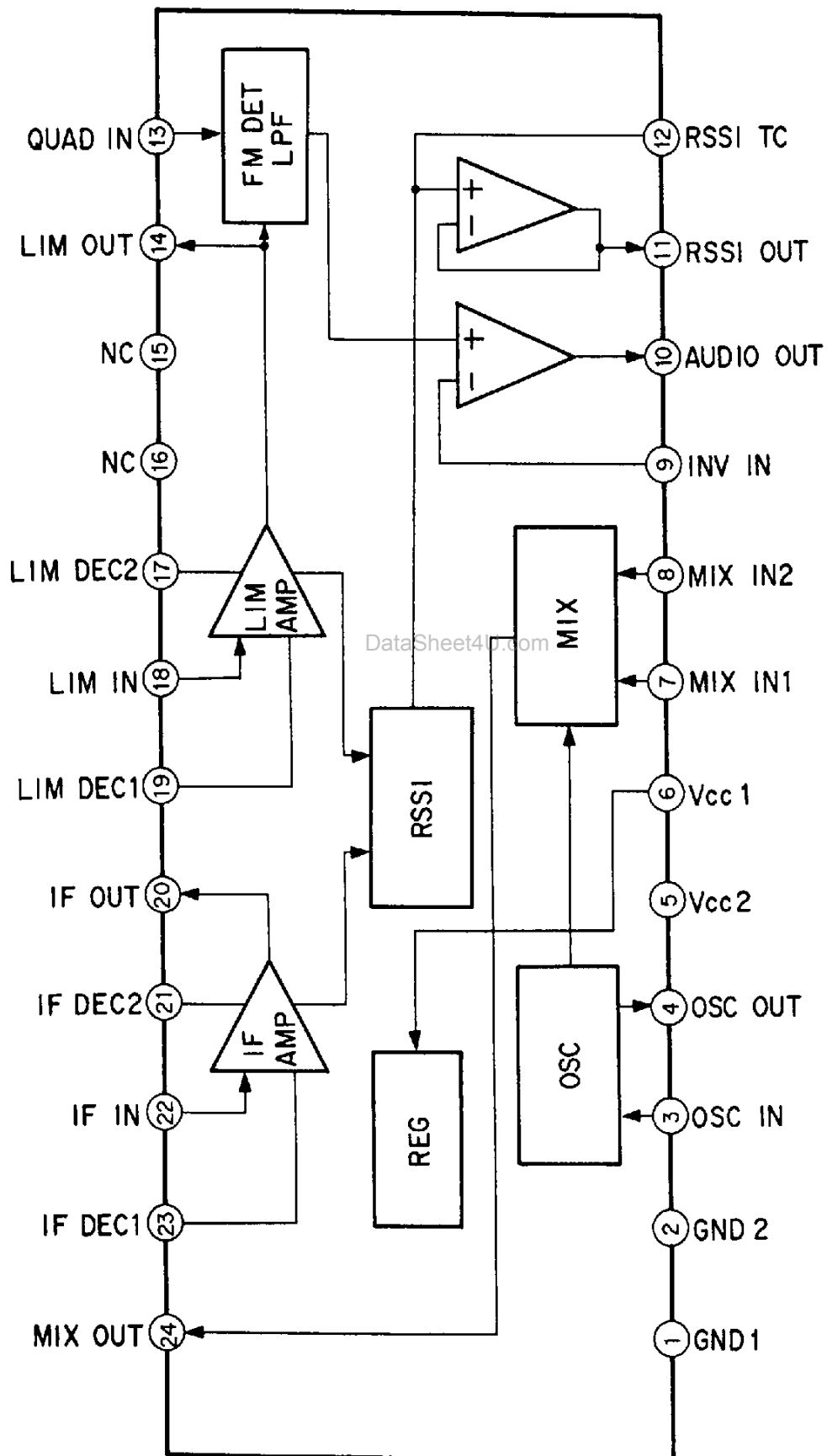

Pin Description

No.	Symbol	Voltage (Typ.)	Equivalent circuit	Description
1 2	GND1 GND2	0V		Grounding pin
3 4	OSC IN OSC OUT	3.0V 2.3V		<p>Connect a crystal oscillator to compose a Colpitts type oscillation circuit.</p> <p>In case of using an external oscillator, input a signal to pin ③ and connect pin ④ to Vcc.</p>
5 6	Vcc2 Vcc1	5.0V		Power supply pin
7 8	MIX IN1 MIX IN2	1.2V 1.2V		<p>Input pin of mixer.</p> <p>In case of using a single input, connect pin ⑧ to GND with capacitor.</p>
9	INV IN	2.5V		Inverse input pin of the audio output amplifier
10	AUDIO OUT	2.5V		Output pin of the FM-detected signal. Amplifier gain can be adjusted by connecting an appropriate feedback circuit between this pin and pin ⑨.
11	RSSI OUT			RSSI output pin. Output voltage is corresponding to the level of signals input to the IF and LIM amplifiers.
12	RSSI TC			Time constant pin for RSSI. Current output is converted into voltage by connecting an appropriate R, C parallel circuit.

No.	Symbol	Voltage (Typ.)	Equivalent circuit	Description
13	QUAD IN	3.3V		Input pin of quadrature detecting circuit. Connect a resonance circuit between pin ⑬ and ⑭.
14	LIM OUT	1.7V		Output pin of limiter.
17 18 19	LIM DEC2 LIM IN LIM DEC1	1.7V 1.7V 1.7V		Input and decoupling pin of limiter. Connect pin ⑰ and ⑱ to GND with capacitor (0.01 to 0.047 μ F).
20	IF OUT	1.6V		Output pin of IF amp.
21 22 23	IF DEC2 IF IN IF DEC1	1.6V 1.6V 1.6V		Input pin and decoupling pin of IF amp. Connect pin ⑳ and ㉓ to GND with capacitor (0.01 to 0.047 μ F).
24	MIX OUT	3.8V		Output pin of mixer.

Electrical Characteristics (Ta = 25°C, Vcc = 5V See the Electrical Characteristics Test Circuit)
0dBm = 223.6mVrms

No.	Item	Symbol	SW which turns ON	Input signal, No.	Remark	Test point	Min.	Typ.	Max.	Unit
1	Consumption current	Icc				I1	4.7	5.7	7.3	mA
2	Mixer conversion gain	VG1		VIN1 : 80.0MHz, - 40dBm VIN2 : 80.455MHz, 10dBm	fOUT = 455kHz Output level of 455kHz component input level of pin ①.	V1	18	20	22	dB
3	3rd order intercepting point	IM1		VIN1 : 80.06MHz VIN2 : 80.12MHz VIN3 : 80.455MHz, 10dBm	fOUT = 455kHz See Note	V1	- 6.0	- 4.5		dBm
4	Oscillator output voltage	VO1	S1, S2		0dB = 223.6mVrms	V2	- 5	0	5	dB
5	IF amp voltage gain	VG2		VIN4 : 455kHz, - 50dBm		V3	34	36	38	dB
6	Limiting voltage gain	VG3		VIN5 : 455kHz, - 90dBm		V4	70	72	74	dB
7	Limiting output voltage	VO3		VIN5 : 455kHz, - 20dBm		V4	500	570	640	mVp-p
8	Audio output voltage	VO4	S5	VIN5 : 455kHz, - 20dBm fA = 1kHz, DEV = ± 8kHz FM	GV = 1, RL = 2kΩ	V5	155	195	245	mVrms
9	Audio output S/N	SN4	S5		GV = 1, RL = 2kΩ	V5	40			dB
10	Audio output AMRR	AR4	S5	VIN5 : 455kHz, - 20dBm fA = 1kHz, MOD = 80% AM	GV = 1, RL = 2kΩ	V5	30			dB
11	Audio maximum output voltage	VM4	S5, S6	VIN5 : 455kHz, - 20dBm fA = 1kHz, FM	GV = 7, RL = 2kΩ	V5	3.0			Vp-p
12	Audio output distortion	VD4	S5, S6	VIN5 : 455kHz, - 20dBm fA = 1kHz, FM	GV = 7, RL = 2kΩ, Adjust DEV. AFout = 2.5V	V5			1	%
13	Audio output impedance	ZO4			GV = 1				10	Ω
14	RSSI output voltage L	VL5		VIN4 : 455kHz, - 100dBm		V6	0.25	0.40	0.55	V
15	RSSI output voltage H	VH5		VIN5 : 455kHz, - 20dBm		V6	1.50	1.85	2.20	V
16	RSSI output impedance	ZO5					80	100	130	Ω

Description of Operation

The signals which have been input from pins ⑦ and ⑧ are mixed with the local oscillation signals from the oscillator in the mixer, and the frequency converted signal is output from pin ⑭. The oscillator is self-oscillated by composing Colpitts type crystal oscillation circuit between pin ③ and ④. In addition, it is possible to apply a local oscillation signal to pin ③ from the external circuit. After the bandwidth is limited by BPF, the mixer output is amplified by IF amplifier and output from pin ⑭. The IF amplifier output is limited its bandwidth again, and amplitude limited by the limiter and output from pin ⑭. The limiter amplifier output is phase-shifted by LC resonance circuit, etc., and audio signal is output from pin ⑩ after being quadrature detected.

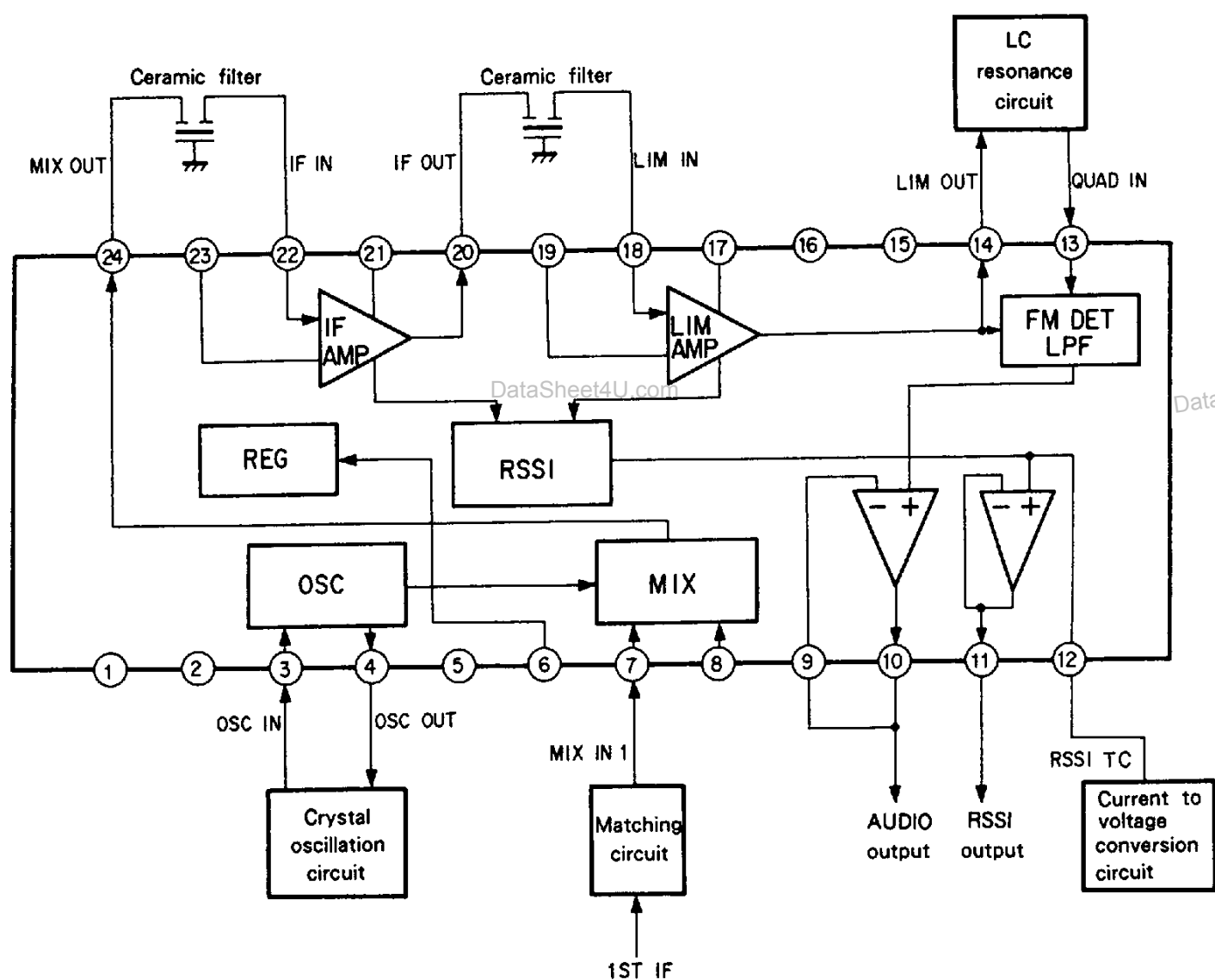

The RSSI output is the currents corresponding to the input levels at the IF amplifier and the limiter. It is possible to convert a current into a voltage by connecting a proper I. V conversion circuit.

Application Circuit

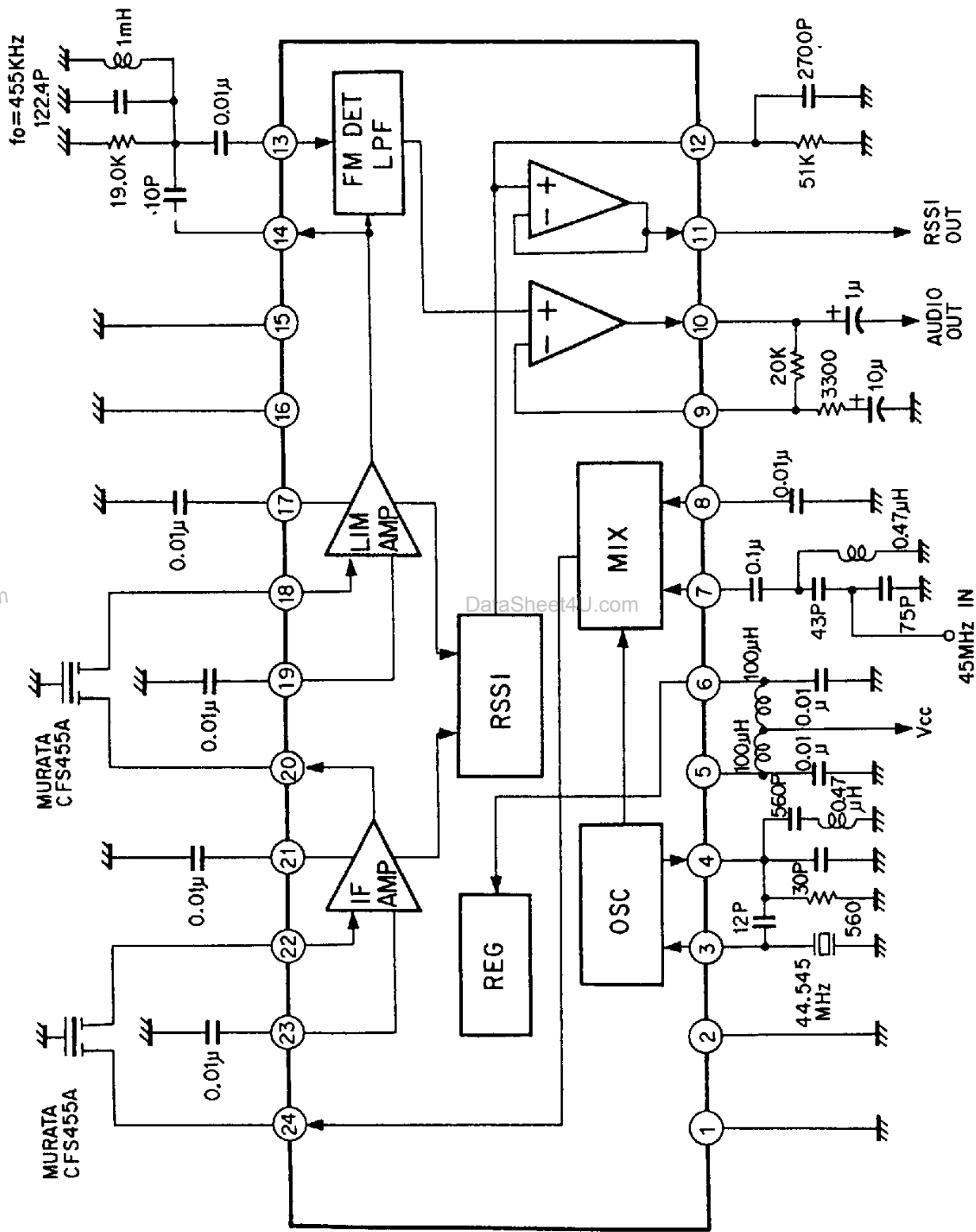

Note on Use

CXA1343M/N have very high at voltage gain, so take care of the following.

1. Decouple pin ⑤ (V_{CC2}) and ⑥ (V_{CC1}) with L and C as near to the pins as possible.
2. Connect pin ⑮ and ⑯ (NC) to GND.
3. Separate input line from the output line as far as possible, and make the wiring short.
4. Connect pin ⑧, ⑳, ㉓, ㉑ and ㉒ to GND with capacitor as near to pins as possible.
5. The GND impedance should be as low as possible.
6. It is better to separate statically the input from the output of the limiter with shielding plate.

Notes on Application

1) Power supply

The CXA1343M/N have a voltage regulator within the IC, so these have wide operating power supply range (+4.5 to +9.5V; Typ: 5.0V). There is little change in characteristics in the operating range. Decouple pin ⑤ (V_{CC2}) and ⑥ (V_{CC1}) with L and C. (See Fig. right)

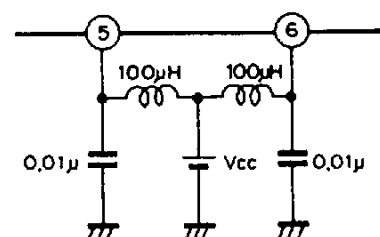

Power supply decoupling

2) Oscillator

The method to use oscillator of CXA1343M/N is the following:

- (a) Method to input from pin ③ with the self-excitation oscillation signal by composing a crystal oscillation circuit of the Colpitts type to pin ③ and ④.
- (b) Method to input directly the external local oscillation signal to pin ③.

< Crystal oscillation circuit >

The 3rd overtone crystal oscillation circuit of the Colpitts type is Fig. bellow.

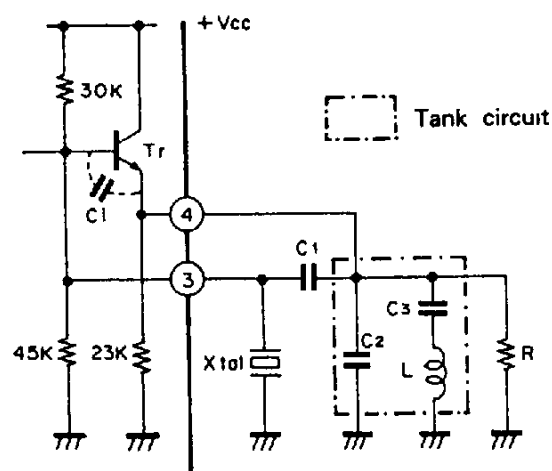

Colpitts type crystal oscillation circuit

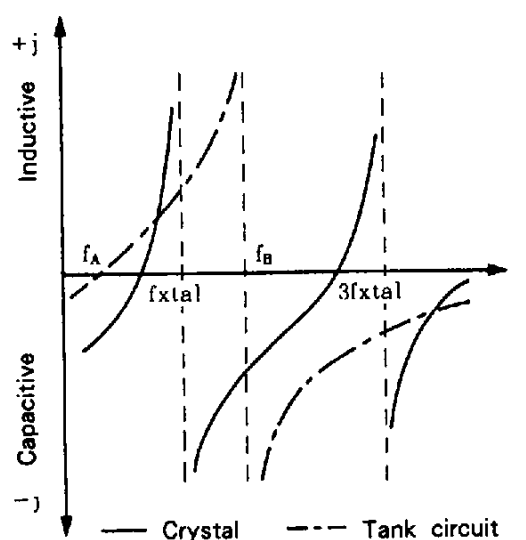

Reactance characteristics

The conditions of the 3rd overtone oscillation of this oscillation circuit are the following.

- The parallel resonance frequency (f_B) of the tank circuit should be smaller than the 3rd oscillation frequency ($3f_{xtal}$) and the serial resonance frequency (f_A) should be smaller than the basic oscillation frequency (f_{xtal}) ($3f_{xtal} > f_B$, $f_{xtal} > f_A$).
- The load capacitance (C_L) of the crystal should be adequate.
- The f_t of the amplifier (T_r) should be sufficiently larger than $3f_{xtal}$.

The constant is determined so as to satisfy these conditions.

The oscillation level is set at 280 to 890mVrms (Typ: 500mVrms) and adjust the level by changing the resistance value (R). The slight adjustments of the oscillation frequency and oscillation level are performed with C_2 and L.

< In case of direct input >

In case of direct input, connect pin ④ to V_{cc} and input external local oscillation signal to pin ③.

Input level at this point is also 280 to 890mVrms (Typ: 500mVrms).

3) Mixer

Mixer of the CXA1343M/N is a double balance type. Input ports are pin ⑦ and ⑧, and in case of single input, input signal to pin ⑦, and connect pin ⑧ to GND with capacitor. It is possible to use differential input. The standard input level is -110 to -30 dBm (0.7μ to 7.0mVrms), and input through a suitable matching circuit.

4) Filter

The band-pass filters which are connected between pin ⑭ and ⑫ and between pin ⑫ and ⑩ of the CXA1343M/N are desired to have the specifications as follows.

- Input/output impedance : $1.5k \Omega \pm 10 \%$
- Insertion loss (center frequency) : < 6 dB

5) Phase shifter

Input to pin ⑬ to shift the phase of the limiter output (pin ⑭) 90° by the RLC parallel resonance circuit or the discriminator, etc. in order to quadrature FM detection. The Fig. below shows the RLC phase shifter. In this case, determine the L and C values so that the 2nd IF signal frequency and the parallel resonance frequency are the same, and the audio output level is determined by R value. RLC Phase shifter or Oscillator is connected between pin ⑬ and ⑭, the phase shifted signal is input to pin ⑬ and demodulated in quadrature detector.

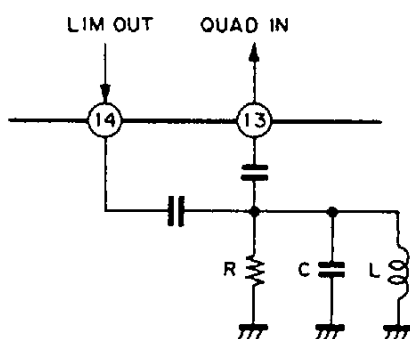

RLC phase shifter

6) Audio output

The FM modulated audio signal is demodulated in the prior stage and is output from pin ⑩ (AUDIO OUT). Amplifier gain can be adjusted by connecting an appropriate feedback circuit between this pin and pin ⑪.

7) RSSI

RSSI is a function that detects input signal level. In this CXA1343/N, the current output is converted into voltage by the current/voltage conversion circuit connected to pin 12, then it is output from pin 11. The signal is amplified almost uniformly within the IF input level range from -100 to 0 dBm (2.24μ to 224 mVrms). The power supply and temperature effect little on output current. However, the output current is distributed within the range of ± 20 % due to the resistance within the IC.

The value of resistances connected to pin ⑫ is determined by the RSSI maximum output current and the allowable maximum voltage of pin ⑫. The RSSI maximum output current is approximately 60μ A (Typ: 45μ A) and the allowable maximum voltage (recommended maximum voltage) is $V_{CC} - 1.8$ V, select the resistance according to the power supply and the required output voltage. In case the output voltage is required above $V_{CC} - 1.8$ V, amplify a voltage using an operational amplifier, etc.

The AMPS defines that the RSSI output voltage increases monotonously from 0. The CXA1343M/N have an offset of approximately 0.3 to 0.5V ($V_{CC} = 5$ V $R_L = 51$ k Ω), so perform from 0V with the offset correction circuit.

DataSheet4U.com

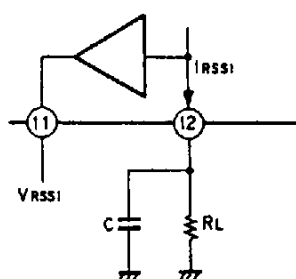

Current to voltage conversion with resistance of RSSI output

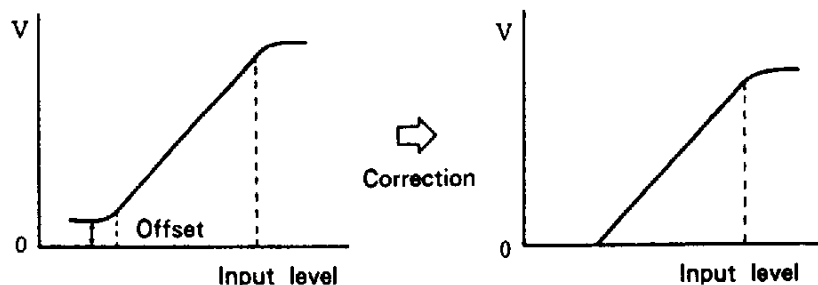

Offset correction of RSSI output voltage

Mixer I/O characteristics and the 3rd order intercepting point

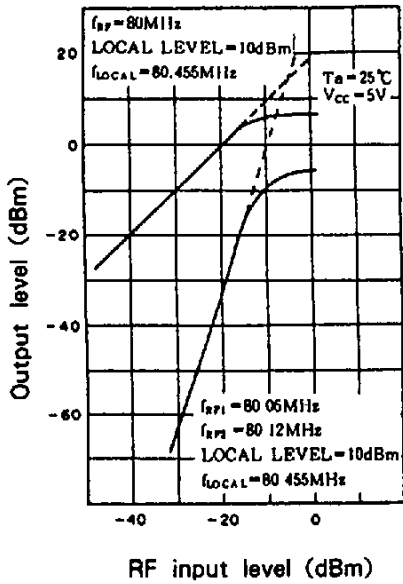

Mixer conversion gain vs. Local input level

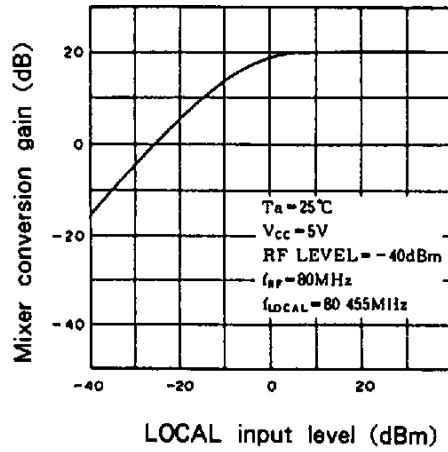

Mixer conversion gain frequency characteristics

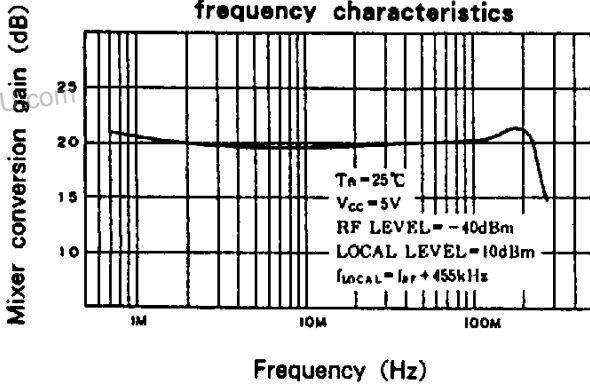

IF amplifier voltage gain frequency characteristics

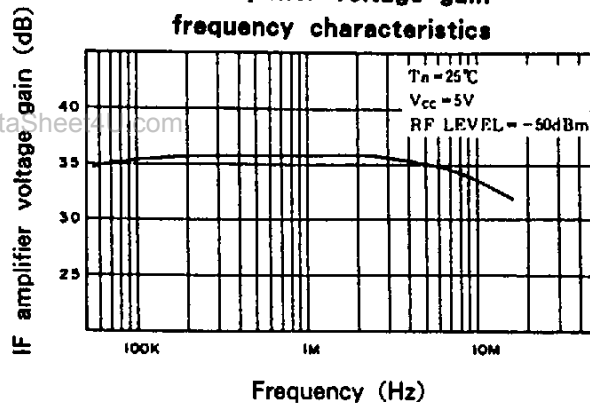

Limiter voltage gain frequency characteristics

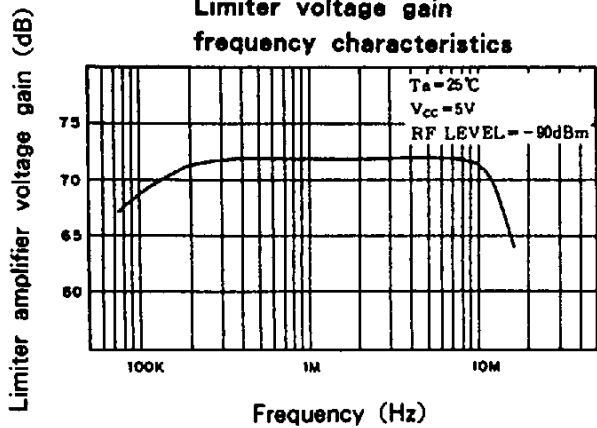

Audio demodulation characteristics (IF IN/Audio OUT)

* Uses AUDIO MEASUREMENT CIRCUIT

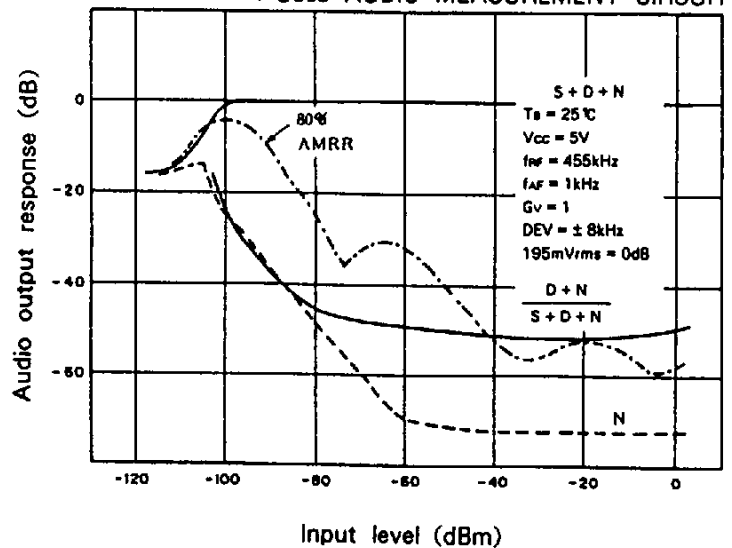

Audio I/O characteristics

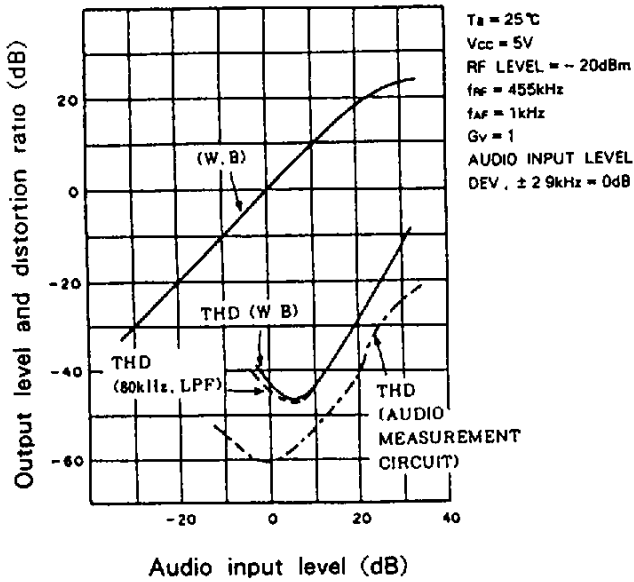

RSSI characteristics (MIX IN/RSSI OUT)

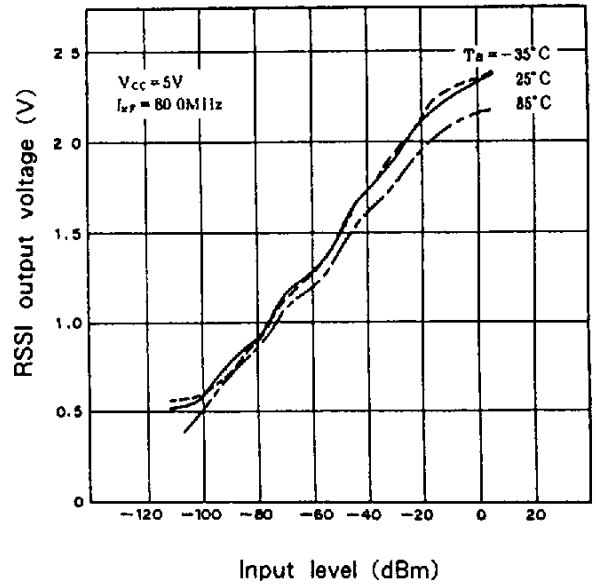

RX-audio filter frequency characteristics
(A - B : AMPS Typ.) (BPF + DEEMP)

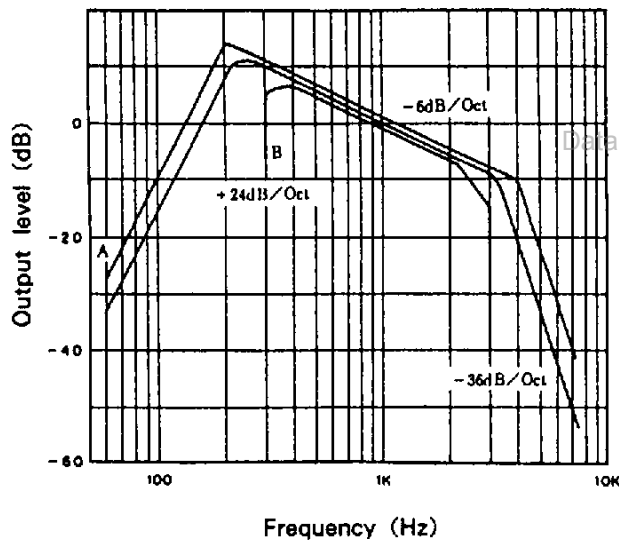



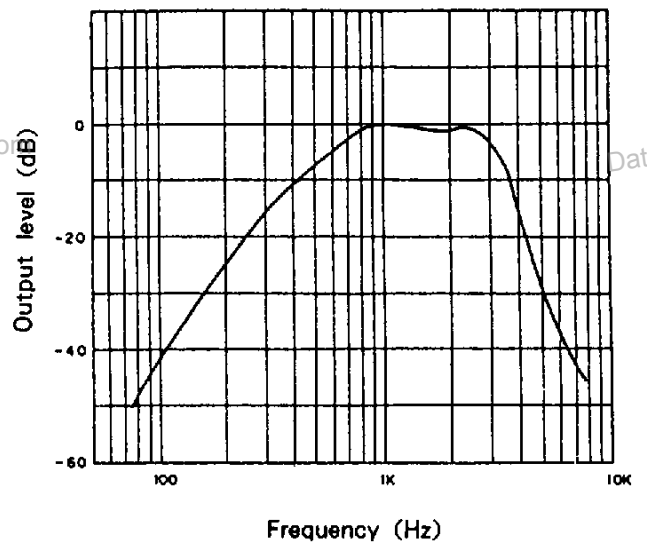



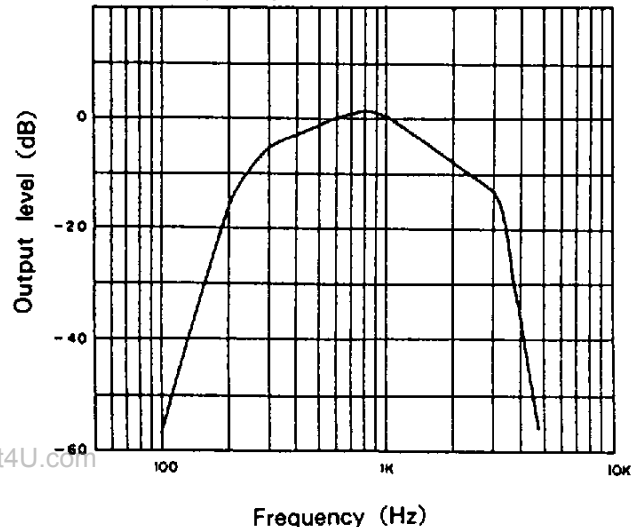







C-message filter frequency characteristics



Audio measurement circuit frequency characteristics



Package Name

Type	Package name		Package	Features				
	Symbol	Description		Material*	Lead pitch	Lead shape	Lead pull out direction	
Inserted	Standard	D I P	DUAL IN-LINE PACKAGE		P C	2.54mm (100MIL)	Through Hole Lead	2-direction
		S I P	SINGLE IN LINE PACKAGE		P	2.54mm (100MIL)	Through Hole Lead	1-direction
		Z I P	ZIG ZAG IN-LINE PACKAGE		P	2.54mm (100MIL) Zig-Zag in-line	Through Hole Lead	1-direction
		P G A	PIN GRID ARRAY		C	2.54mm (100MIL)	Through Hole Lead	Package under side
		PIGGY BACK	PIGGY BACK		C	2.54mm (100MIL)	Through Hole Lead	2-direction
	Shrink	SDIP	SHRINK DUAL IN-LINE PACKAGE		P	1.778mm (70MIL)	Through Hole Lead	2-direction
	SZIP	SHRINK ZIG-ZAG IN-LINE PACKAGE		P	1.778mm (70MIL) Zig-Zag in-line	Through Hole Lead	1-direction	
Surface mounted	Standard flat package	Q F P	QUAD FLAT L LEADED PACKAGE		P C	1.0mm 0.8mm 0.65mm	Gull-Wing	4-direction
		S O P	SMALL OUTLINE L-LEADED PACKAGE		P	1.27mm (50MIL)	Gull-Wing	2-direction
	Standard 2-direction chip carrier	S O J	SMALL OUTLINE J-LEADED PACKAGE		P	1.27mm (50MIL)	J-Lead	2-direction
	Shrink flat package	VQFP	VERY SMALL QUAD FLAT PACKAGE		P	0.5mm	Gull-Wing	4-direction
		VSOP	VERY SMALL OUTLINE PACKAGE		P	0.65mm	Gull-Wing	2-direction
		TSOP	THIN SMALL OUTLINE PACKAGE		P	0.5mm (0.55mm)	Gull-Wing	2-direction
	Standard chip carrier	Q F J	QUAD FLAT J-LEADED PACKAGE		P	1.27mm (50MIL)	J-Lead	4-direction
		Q F N	QUAD FLAT NON-LEADED PACKAGE		C	1.27mm (50MIL)	Leadless	Package under side

*PPlastic, CCeramic