

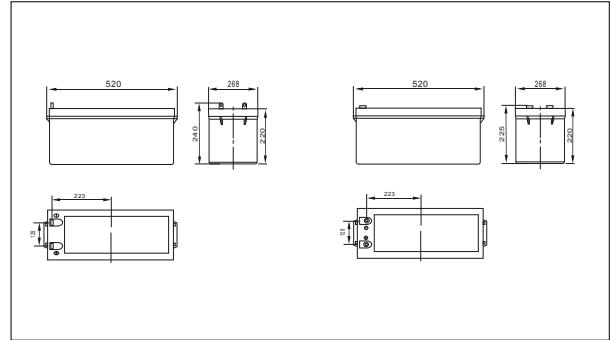

SW122500(12V250AH)



Outer dimensions (mm)



Specifications

Nominal Voltage		12V
Rated capacity (10 hour rate)		250 Ah
Dimensions	Total Height	241 mm (9.29inches)
	Height	220 mm (8.66 inches)
	Length	520 mm (20.5 inches)
	Width	268 mm (10.55 inches)
Weight Approx		76 Kg (174 lbs)

Terminal Type (mm)

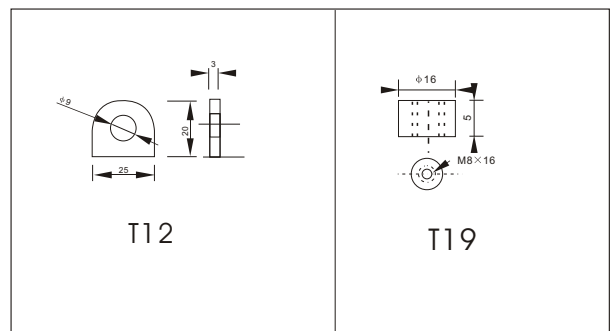

Characteristics

Capacity 25°C(77°F)	10 hour rate(25.0A) 5 hour rate(40.0A) 1 hour rate(150A)	250 AH 200AH 150 AH
Internal Resistance	Full charged Battery at 25°C(77°F)	approx 2.0 m Ω
Capacity affected by Temperature (10hour rate)	40°C(104°F) 25°C(77°F) 0°C(32°F) -15°C(5°F)	102% 100% 85% 65%
Self-Discharge at 25°C(77°F)	Capacity after 3 month storage Capacity after 6 month storage Capacity after 12 month storage	91% 82% 64%
Terminal	T12.T19	
Charge (constant Voltage)	Cycle	Initial Charging Current less than 100 A Voltage 14.10-14.40V
	Float	Voltage 13.50-13.80V

Discharge Curves 25°C(77°F)

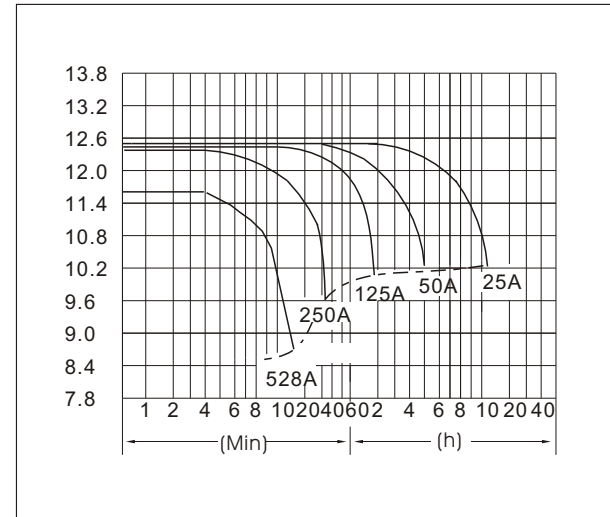

Constant Current(Amp) and Constant Power(Watt) Discharge Table at 25°C(77°F)

Time		5min	10min	15min	30min	1h	2h	3h	4h	5h	8h	10h	20h
9.60V	A	801	528	425	285.0	150.0	87.5	64.3	50.0	41.3	29.25	26.25	14.18
	W	8264	5634	4560	3064	1620	961	715	563	469	335	303	164.8
10.20V	A	776	476	401	272.5	141.0	83.5	62.5	48.8	40.5	28.50	25.75	13.75
	W	8282	5315	4482	3059	1595	962	724	567	472	333	303	161.3
10.50V	A	750	426	350	255.0	136.5	81.5	61.0	48.0	40.0	28.25	25.25	13.75
	W	8193	4843	3997	2935	1581	945	711	562	469	332	299	162.5
10.80V	A	723	401	326	235.0	132.0	79.5	59.5	47.3	39.0	27.50	25.00	13.50
	W	8112	4627	3750	2723	1536	931	702	558	461	326	297	160.8
11.10V	A	699	376	301	210.0	127.5	77.5	57.5	46.0	38.0	26.75	23.75	12.75
	W	7924	4354	3498	2457	1499	916	683	548	453	320	286.7	154.5