

# Technical Information

PrimeSTACK

# 2PS1200R17KE3-4GH



**Zieldaten**  
**target data**

## Key data

1x 629A AC at 690V AC, forced air (fan not implemented)

## General information for:

**Stacks for various inverter application. Semiconductors, heat sinks, drivers and sensors included. These are only technical data!**

**Please read carefully the complete documentation and maintain the proper design environment! Especially note the EMC environment and the controller's functionality.**

Topology	1/2 B2I	
Application / Modulation	Inverter / Sine	
Load type	resistive, inductive	
Cooling	forced air (fan not implemented)	
Market	common industrial, drives, power supply	
Monitors	current, temperature	
Semicond. (Unit 1)	none	
DC Link		
Semicond. (Unit 2)	IGBT	4x FF300R17KE3
Interface IGBT	electrical CMOS	
Standards	EN50178, UL94, prepared for UL508C	
Product ID (eupec)	28476	
Mechanical drawing number	38000031	
Electrical drawing number	2PS-C4-V	

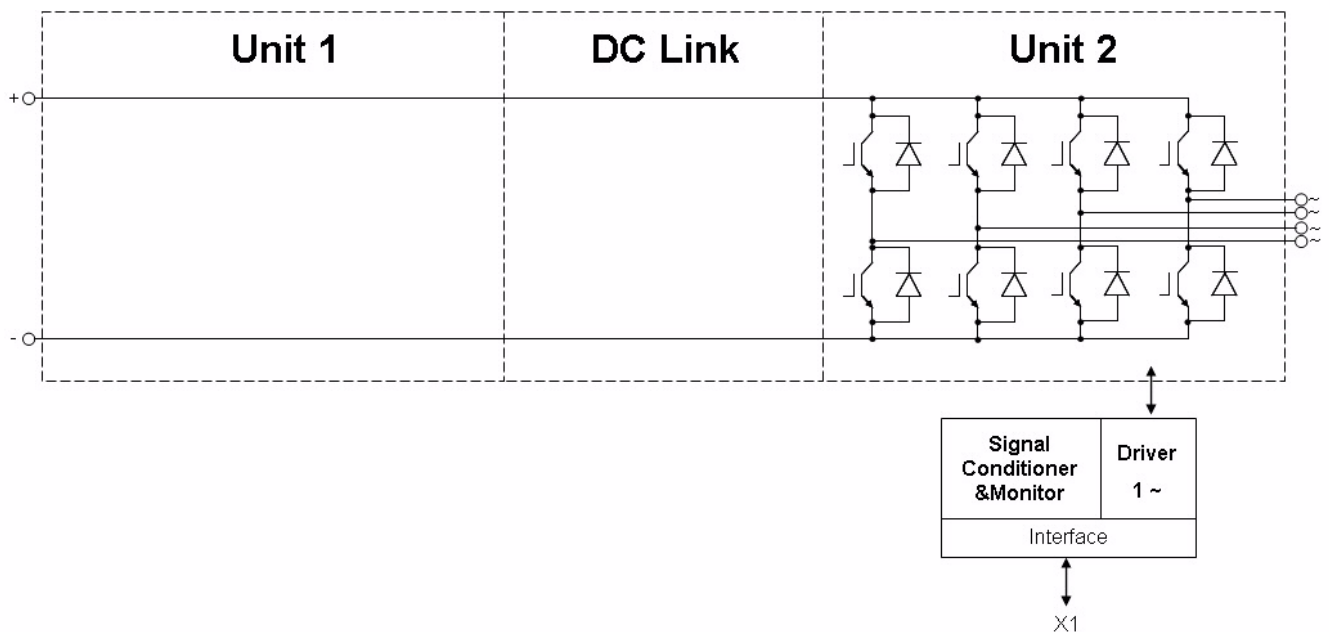
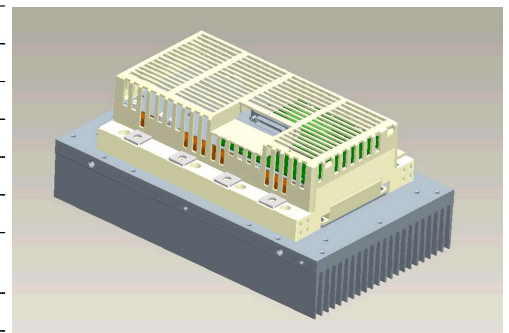

prepared by: Hoelbe Oliver	date of publication: 2008-04-11
approved by: Jürgen Schiele	revision: 1.2



**Zieldaten  
target data**

**Note**

**Overvoltage and Overcurrent shutdown:**  
 - It must be realized by the customer.  
**Overvoltage and Overcurrent shutdown reaction time:**  
 - This parameter refers to the customers controller.

**Electrical data**

DC Link			min	typ	max	units
Voltage		V <sub>DC</sub>		1100	1200	V

Unit 2 AC			min	typ	max	units
Voltage	depending on controller	V <sub>Unit2</sub>		690		V <sub>RMS</sub>
Continuous current	V <sub>Unit2</sub> = 690V <sub>RMS</sub> , V <sub>DC</sub> = 1100V, T <sub>inlet</sub> = 40°C, T <sub>J</sub> ≤ 125°C, f <sub>Unit2</sub> = 50Hz, f <sub>sw2</sub> = 2000Hz, cos(phi) = 0,85	I <sub>Unit2</sub>			629	A <sub>RMS</sub>
Continuous current overload cap.	T <sub>inlet</sub> = 40°C, for overload capability 150% for 60s			452		A <sub>RMS</sub>
Short time current	T <sub>inlet</sub> = 40°C, 10s, every 180s, initial load = 551A <sub>RMS</sub>	I <sub>Unit2</sub>			689	A <sub>RMS</sub>
DC current	no rotating field, T <sub>inlet</sub> = 40°C	I <sub>Unit2 DC</sub>			301,0	A <sub>av</sub>
Overcurrent shutdown	within 15µs			1860		A <sub>peak</sub>
Switching frequency		f <sub>sw2</sub>			6000	Hz
Power losses	V <sub>Unit2</sub> = 690V, V <sub>DC</sub> = 1100V, T <sub>inlet</sub> = 40°C, T <sub>J</sub> ≤ 125°C, f <sub>Unit2</sub> = 50Hz, f <sub>sw2</sub> = 2000Hz, cos(phi) = 0,85, I <sub>Unit2</sub> = 629A <sub>RMS</sub>	P <sub>loss2</sub>		2390		W
Power factor		cos(phi) <sub>Unit2</sub>	-1,00		1,00	

General data			min	typ	max	units
Power losses (PCB)		P <sub>loss aux</sub>			t.b.d.	W
EMC test	according to IEC61800-3 at named interfaces	power	V <sub>Burst</sub>	2		kV
		control	V <sub>Burst</sub>	1		kV
		aux (24V)	V <sub>Surge</sub>	1		kV
Insulation management is designed for		V <sub>Line</sub>		690		V <sub>RMS</sub>
Insulation test voltage	according to EN50178, f = 50Hz, t = 60s	V <sub>isol</sub>		2,5		kV <sub>RMS</sub>

prepared by: Hoelbe Oliver	date of publication: 2008-04-11
approved by: Jürgen Schiele	revision: 1.2

# Technical Information

PrimeSTACK

# 2PS1200R17KE3-4GH



## Zieldaten target data

### Controller interface data

			min	typ	max	units
Auxiliary voltage		$V_{aux}$	18	24	30	$V_{av}$
Auxiliary power requirement	$V_{aux} = 24V_{av}$	$P_{aux}$	40			W
Driver and interface board	see separate technical information		DR240			
Driver core			EiceDRIVER 2ED300C17-S			
Digital input level	resistor to GND 10,0k $\Omega$ , capacitor to GND 1nF	$V_{in}$	0,0		15,0	V
Digital output level	open collector, low = ok, max 15mA	$V_{out}$	0,0		30,0	V
Analog current outputs Unit 2	load max 1mA; at 629A	$V_{ana out}$	3,38	3,45	3,52	V
Analog temperature output	load max 1mA; at $T_{NTC} = 84^{\circ}C$ correspond to $T_j = 125^{\circ}C$	$V_{T out}$	10,47	10,68	10,89	V
Overtemperature shutdown	at $T_{NTC} = 84^{\circ}C$ correspond to $T_j = 125^{\circ}C$	$V_{T out OT}$		10,68		V
Overvoltage shutdown reaction time	after overvoltage message by PrimeSTACK interface				50	$\mu s$
Overcurrent shutdown reaction time	after overvoltage message by PrimeSTACK interface				10	$\mu s$

### Heat sink air cooled / Thermal data

			min	typ	max	units
Airflow	$T_{Air} = 20^{\circ}C$ , $P_{air} = 1013hPa$ , dry- and dust free, measured on side of heat sink. according to DIN 41882	$\Delta V / \Delta t_{Air}$	500			$m^3/h$
Air pressure drop		$\Delta p_{Air}$		540		Pa
Cooling air inlet temperature	heat sink temperature $> -25^{\circ}C$	$T_{inlet}$	-40		40	$^{\circ}C$

prepared by: Hoelbe Oliver	date of publication: 2008-04-11
approved by: Jürgen Schiele	revision: 1.2



**Zieldaten  
target data**

**IGBT data unit 2**

Type	assumed		min	typ	max	units
collector-emitter saturation voltage	$I_c = 300A; V_{ge} = 15V$	$V_{CE\ sat}$		2,4		V
parameter for linear model	$T_{vj} = 25^\circ C$	$V_{ce1}$		1,025		V
parameter for linear model	$T_{vj} = 25^\circ C$	$r_{ce1}$		3,25		mΩ
parameter for linear model	$T_{vj} = 125^\circ C$	$V_{ce2}$		0,975		V
parameter for linear model	$T_{vj} = 125^\circ C$	$r_{ce2}$		4,75		mΩ
turn-on / turn-off energy loss per pulse	$T_{vj} = 25^\circ C$	$E_1$		71 / 64		mJ
turn-on / turn-off energy loss per pulse	$T_{vj} = 125^\circ C$	$E_2$		105 / 94		mJ
thermal resistance, junction to case	per IGBT	$R_{thjc}$		0,085		K/W
thermal resistance, case to heatsink	per IGBT	$R_{thch}$		0,033		K/W

**Diode data unit 2**

Type	assumed		min	typ	max	units
forward voltage	$I_F = 300A; V_{ge} = 0V$	$V_F$		1,9		V
parameter for linear model	$T_{vj} = 25^\circ C$	$V_{F1}$		1,035		V
parameter for linear model	$T_{vj} = 25^\circ C$	$r_{F1}$		2,55		mΩ
parameter for linear model	$T_{vj} = 125^\circ C$	$V_{F2}$		0,925		V
parameter for linear model	$T_{vj} = 125^\circ C$	$r_{F2}$		3,25		mΩ
reverse recovery energy	$T_{vj} = 25^\circ C$	$E_{rec1}$		40		mJ
reverse recovery energy	$T_{vj} = 125^\circ C$	$E_{rec2}$		72		mJ
thermal resistance, junction to case	per Diode	$R_{thjc}$		0,13		K/W
thermal resistance, case to heatsink	per Diode	$R_{thch}$		0,051		K/W

prepared by: Hoelbe Oliver	date of publication: 2008-04-11
approved by: Jürgen Schiele	revision: 1.2

# Technical Information

PrimeSTACK

# 2PS1200R17KE3-4GH



## Zieldaten target data

### Environmental conditions

			min	typ	max	units
Storage temperature		$T_{stor}$	-40		85	°C
Ambient temperature (PCB)		$T_{amp}$	-25		55	°C
Operating temperature	see chapter Heat sink air cooled / Thermal data					
Cooling air velocity (PCB)		$V_{Air PCB}$	0,3			m/s
Air pressure	standard atmosphere	$p_{Air}$	900		1100	hPa
Humidity	no condensation	Rel. F	5		85	%
Installation height			0		1000	m
Vibration	according to IEC60721				5	m/s <sup>2</sup>
Shock	according to IEC60721				40	m/s <sup>2</sup>
Protection degree			IP00			
Pollution degree			2			
Torque at DC Terminals		$M_{DC}$	6,0		10,0	Nm
Torque at AC Terminals		$M_{AC}$	16,0		20,0	Nm
Dimensions	width × depth × height		216	360	165	mm
Weight with heat sink	approximation			12,8		kg
Weight without heat sink	approximation			3,8		kg

### Matching Code

110-12000-0111-0330-0150-400-400-400-00-060427

prepared by: Hoelbe Oliver	date of publication: 2008-04-11
approved by: Jürgen Schiele	revision: 1.2



Zieldaten  
target data

fo - derating curves IGBT (motor)  
cos(phi) = 0,85  
T<sub>cool medium</sub> = 40°C

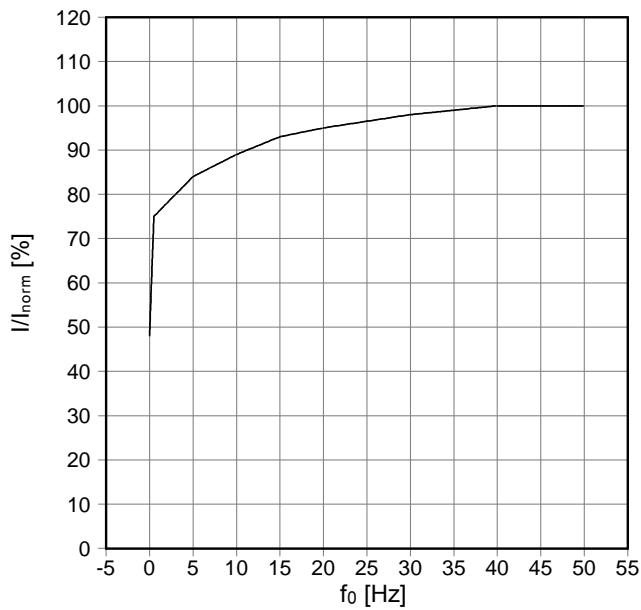

fsw - derating curve IGBT (motor)  
IGBT, cos(phi) = 0,85  
T<sub>cool medium</sub> = 40°C

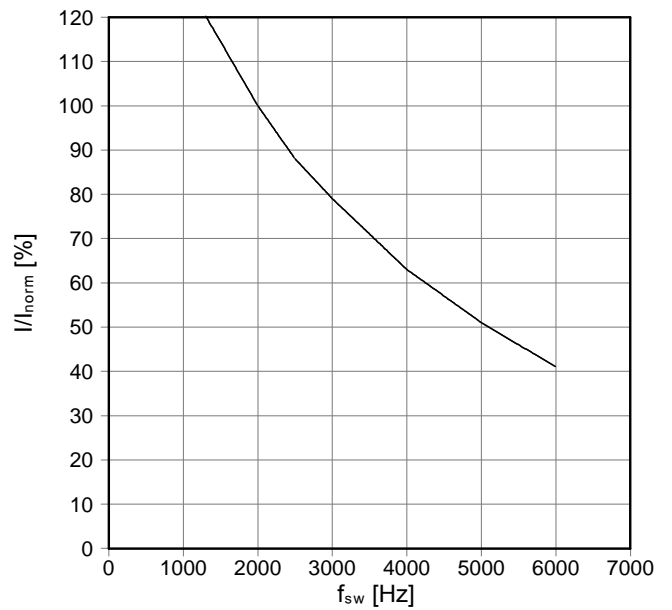

Transient thermal impedance per module  
T<sub>cool medium</sub> = 40

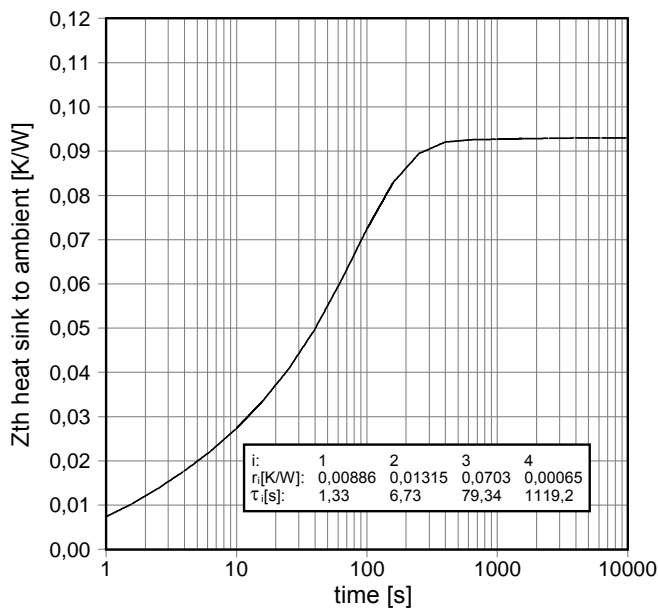

prepared by: Hoelbe Oliver	date of publication: 2008-04-11
approved by: Jürgen Schiele	revision: 1.2

Zieldaten  
target data

Mechanical drawing

2PS...-4...  
4PS...-4...  
6PS...-4...  
PrimeSTACK C4  
38000031

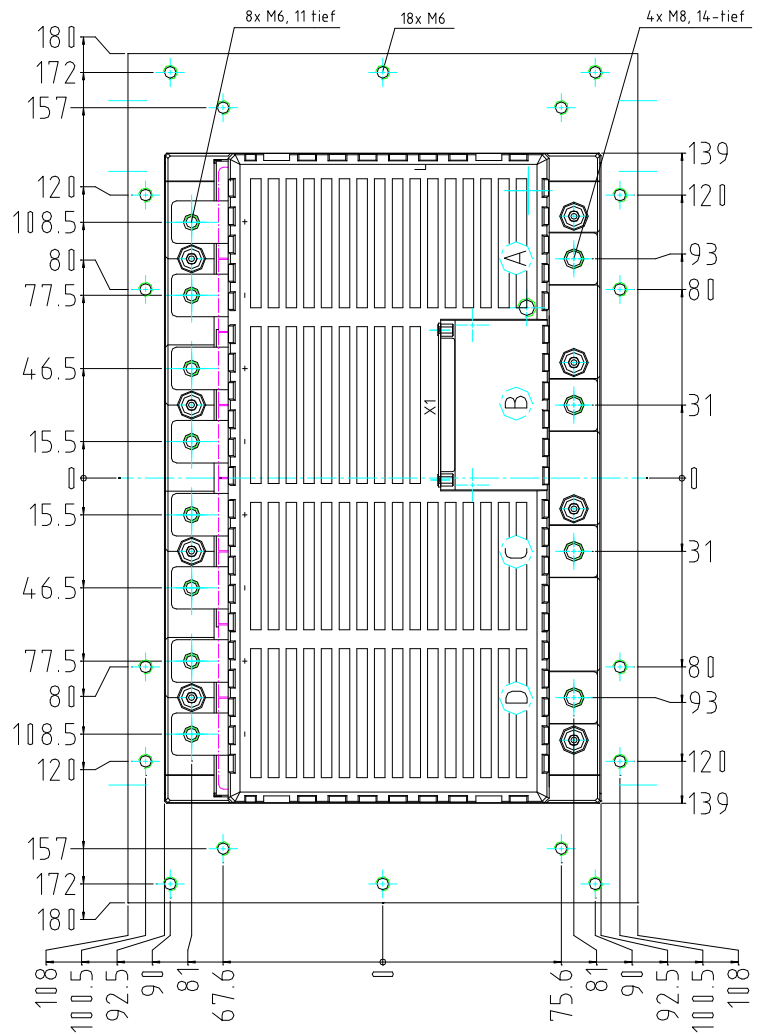
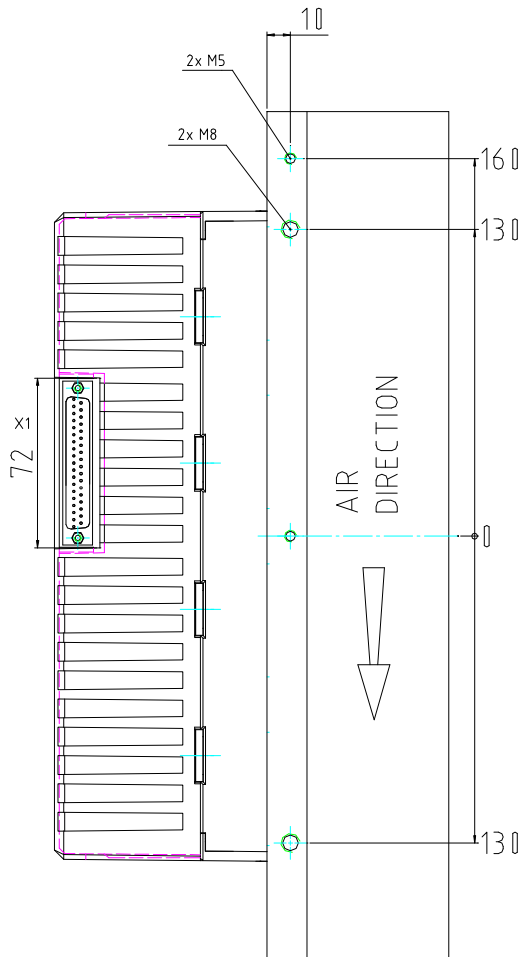
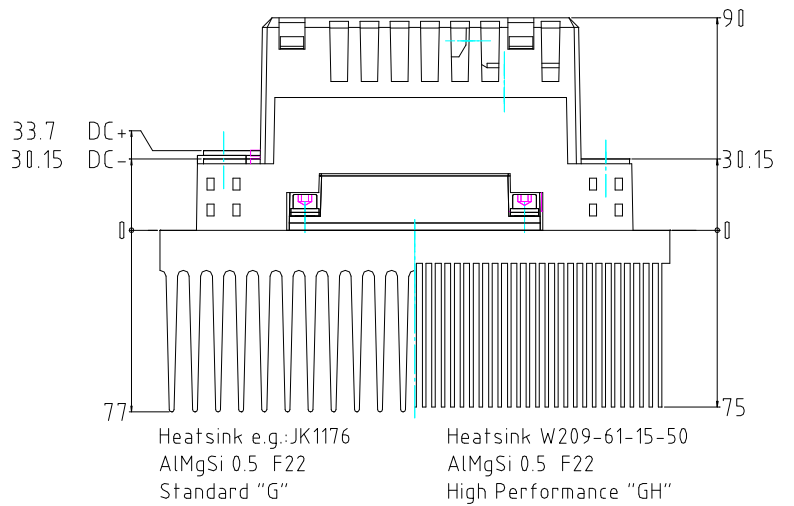

- X1:  
 2PS : SUB-D-Connector 25 pole, male  
 4PS : SUB-D-Connector 25 pole, male  
 6PS : SUB-D-Connector 37 pole, male

prepared by: Hoelbe Oliver	date of publication: 2008-04-11
approved by: Jürgen Schiele	revision: 1.2

Zieldaten  
target data

Circuit diagram

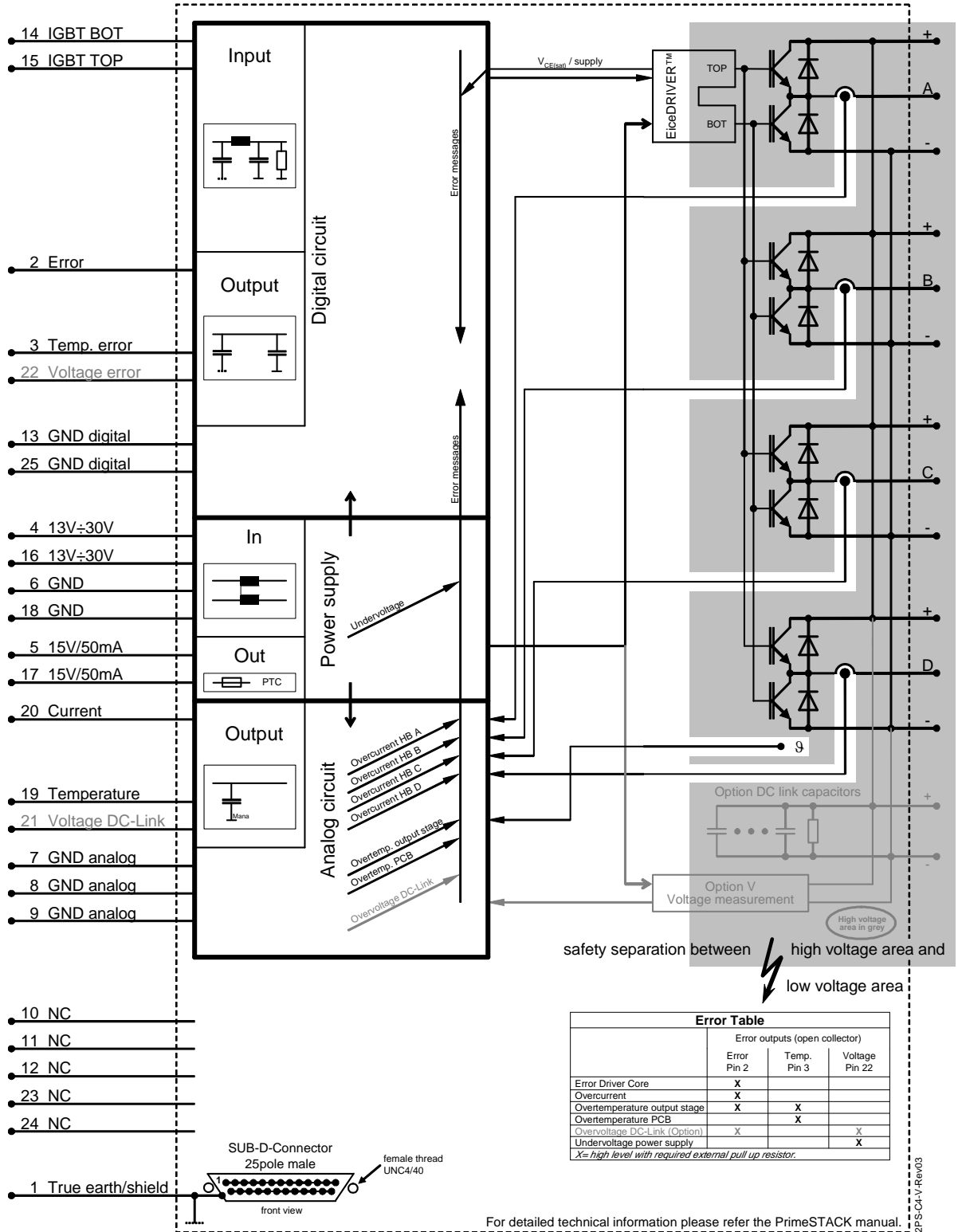

	Error outputs (open collector)		
	Error Pin 2	Temp. Pin 3	Voltage Pin 22
Error Driver Core	X		
Overcurrent	X		
Overtemperature output stage	X	X	
Overtemperature PCB		X	
Overvoltage DC-Link (Option)	X		X
Undervoltage power supply			X

X = high level with required external pull up resistor.

For detailed technical information please refer the PrimeSTACK manual.

2PS04-V Rev03





**Zieldaten  
target data**

**Nutzungsbedingungen**

Die in diesem Produktdatenblatt enthaltenen Daten sind ausschließlich für technisch geschultes Fachpersonal bestimmt. Die Beurteilung der Eignung dieses Produktes für Ihre Anwendung sowie die Beurteilung der Vollständigkeit der bereitgestellten Produktdaten für diese Anwendung obliegt Ihnen bzw. Ihren technischen Abteilungen.

In diesem Produktdatenblatt werden diejenigen Merkmale beschrieben, für die wir eine liefervertragliche Gewährleistung übernehmen. Eine solche Gewährleistung richtet sich ausschließlich nach Maßgabe der im jeweiligen Liefervertrag enthaltenen Bestimmungen. Garantien jeglicher Art werden für das Produkt und dessen Eigenschaften keinesfalls übernommen.

Sollten Sie von uns Produktinformationen benötigen, die über den Inhalt dieses Produktdatenblatts hinausgehen und insbesondere eine spezifische Verwendung und den Einsatz dieses Produktes betreffen, setzen Sie sich bitte mit dem für Sie zuständigen Vertriebsbüro in Verbindung (siehe [www.infineon.com](http://www.infineon.com), Vertrieb&Kontakt). Für Interessenten halten wir Application Notes bereit.

Aufgrund der technischen Anforderungen könnte unser Produkt gesundheitsgefährdende Substanzen enthalten. Bei Rückfragen zu den in diesem Produkt jeweils enthaltenen Substanzen setzen Sie sich bitte ebenfalls mit dem für Sie zuständigen Vertriebsbüro in Verbindung.

Sollten Sie beabsichtigen, das Produkt in Anwendungen der Luftfahrt, in gesundheits- oder lebensgefährdenden oder lebenserhaltenden Anwendungsbereichen einzusetzen, bitten wir um Mitteilung. Wir weisen darauf hin, dass wir für diese Fälle

- die gemeinsame Durchführung eines Risiko- und Qualitätsassessments;
- den Abschluss von speziellen Qualitätssicherungsvereinbarungen;
- die gemeinsame Einführung von Maßnahmen zu einer laufenden Produktbeobachtung dringend empfehlen und gegebenenfalls die Belieferung von der Umsetzung solcher Maßnahmen abhängig machen.

Soweit erforderlich, bitten wir Sie, entsprechende Hinweise an Ihre Kunden zu geben.

Inhaltliche Änderungen dieses Produktdatenblatts bleiben vorbehalten.

**Terms & Conditions of usage**

The data contained in this product data sheet is exclusively intended for technically trained staff. You and your technical departments will have to evaluate the suitability of the product for the intended application and the completeness of the product data with respect to such application.

This product data sheet is describing the characteristics of this product for which a warranty is granted. Any such warranty is granted exclusively pursuant the terms and conditions of the supply agreement. There will be no guarantee of any kind for the product and its characteristics.

Should you require product information in excess of the data given in this product data sheet or which concerns the specific application of our product, please contact the sales office, which is responsible for you (see [www.infineon.com](http://www.infineon.com), sales&contact). For those that are specifically interested we may provide application notes.

Due to technical requirements our product may contain dangerous substances. For information on the types in question please contact the sales office, which is responsible for you.

Should you intend to use the Product in aviation applications, in health or live endangering or life support applications, please notify. Please note, that for any such applications we urgently recommend

- to perform joint Risk and Quality Assessments;
- the conclusion of Quality Agreements;
- to establish joint measures of an ongoing product survey, and that we may make delivery depended on the realization of any such measures.

If and to the extent necessary, please forward equivalent notices to your customers.

Changes of this product data sheet are reserved.

prepared by: Hoelbe Oliver	date of publication: 2008-04-11
approved by: Jürgen Schiele	revision: 1.2



**Sicherheitshinweise**

Bevor Sie mit der Installation und dem Betrieb der Baugruppe beginnen, lesen Sie bitte sorgfältig alle Sicherheitshinweise, Warnungen und beachten Sie die angebrachten Warnschilder. Vergewissern Sie sich, dass alle Warnschilder in leserlichem Zustand verbleiben und fehlende oder beschädigte Schilder ersetzt werden.

**Safety Instructions**

Prior to installation and operation, all safety notices and warnings and all warning signs attached to the equipment have to be carefully read. Make sure that all warning signs remain in a legible condition and that missing or damaged signs are replaced. To installation and operation, all safety notices and warnings and all warning signs attached to the equipment have to be carefully read. Make sure that all warning signs remain in a legible condition and that missing or damaged signs are replaced.

prepared by: Hoelbe Oliver	date of publication: 2008-04-11
approved by: Jürgen Schiele	revision: 1.2