

- Arc barrier equipped
- High dielectric strength (2,000 VAC)
- Long dependable service life assured by AgCdO contacts
- Choose models with single or bifurcated contacts, LED indicator, diode surge suppression, push-to-test button, or RC circuit
- All models meet UL and CSA approvals; VDE, LR, and SEV approved versions are available

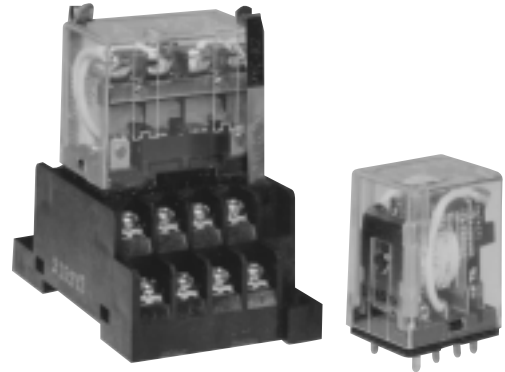

## Ordering Information

To Order: Select the part number and add the desired coil voltage rating (e.g., LY1-DC6).

Type	Terminal	Contact form	Part number					
			Single contact			Bifurcated contact		
			Standard bracket mounting	Upper mounting bracket	Lower mounting bracket	Standard bracket mounting	Upper mounting bracket	Lower mounting bracket
Standard	Plug-in/solder	SPDT	LY1	LY1F	LY1S	—	—	—
		DPDT	LY2	LY2F	LY2S	LY2Z	LY2ZF	LY2ZS
		3PDT	LY3	LY3F	LY3S	—	—	—
		4PDT	LY4	LY4F	LY4S	—	—	—
	PCB	SPDT	LY1-0	—	—	—	—	—
		DPDT	LY2-0	—	—	LY2Z-0	—	—
		3PDT	LY3-0	—	—	—	—	—
		4PDT	LY4-0	—	—	—	—	—
LED indicator	Plug-in/solder	SPDT	LY1N	—	—	—	—	—
		DPDT	LY2N	—	—	LY2ZN	—	—
		3PDT	LY3N	—	—	—	—	—
		4PDT	LY4N	—	—	—	—	—
Diode surge suppression	Plug-in/solder	SPDT	LY1-D	—	—	—	—	—
		DPDT	LY2-D	—	—	LY2Z-D	—	—
		3PDT	LY3-D	—	—	—	—	—
		4PDT	LY4-D	—	—	—	—	—
LED indicator and diode surge suppression	Plug-in/solder	SPDT	LY1N-D2	—	—	—	—	—
		DPDT	LY2N-D2	—	—	LY2ZN-D2	—	—
		4PDT	LY4N-D2	—	—	—	—	—
RC circuit	Plug-in/solder	SPDT	LY1-CR	—	—	—	—	—
		DPDT	LY2-CR	—	—	LY2Z-CR	—	—
LED indicator and RC circuit	Plug-in/solder	SPDT	LY1N-CR	—	—	—	—	—
		DPDT	LY2N-CR	—	—	LY2ZN-CR	—	—

Note: 1. Types with specifications other than those listed are available. Contact your OMRON Sales representative.  
 2. To order connecting sockets and mounting tracks, see "Accessories" section.

## Ordering Information, continued

www.DataSheet4U.com

Type	Terminal	Contact form	Part number					
			Single contact			Bifurcated contact		
			Standard bracket mounting	Upper mounting bracket	Lower mounting bracket	Standard bracket mounting	Upper mounting bracket	Lower mounting bracket
Push-to-test button	Plug-in/solder	SPDT	<b>LY1I4</b>	—	—	—	—	—
		DPDT	<b>LY2I4</b>	—	—	<b>LY2ZI2</b>	—	—
		3PDT	<b>LY3I4</b>	—	—	—	—	—
		4PDT	<b>LY4I4</b>	—	—	—	—	—
LED indicator and push-to-test button	Plug-in/solder	DPDT	<b>LY2I4N</b>	—	—	<b>LY2ZI2N</b>	—	—
		4PDT	<b>LY4I4N</b>	—	—	—	—	—

Note: 1. Types with specifications other than those listed are available. Contact your OMRON Sales representative.  
2. To order connecting sockets and mounting tracks, see "Accessories" section.

## ■ ACCESSORIES

### Connecting Sockets

To Order: Select the appropriate part numbers for sockets, clips, and mounting tracks (if required) from the following charts.

#### Track mounted sockets

Relay	Socket*	Relay hold-down clip		Mounting track
		Standard	RC circuit	
SPDT DPDT	<b>PTF08A-E</b>	<b>PYC-A1</b>	<b>Y92H-3</b>	<b>PFM-100N/PFM-50N &amp; PFM-M or PFM-100N2 PFM-S (Option spacer)</b>
3PDT	<b>PTF11A</b>			
4PDT	<b>PTF14A-E</b>			

\* Track mounted socket can be used as a front connecting socket.

#### Back connecting sockets

Relay	Solder terminal socket	Wire wrap terminal socket	Relay hold-down clip				Socket Mounting Plate			
			Standard	Push-to-test	RC circuit	Mtg. plate	1	10	12	18
SPDT DPDT	<b>PT08</b>	<b>PT08QN</b>	<b>PYC-P</b>	<b>PYC-P2</b>	<b>PYC-1</b>	<b>PYC-S</b>	<b>PYP-1</b>	—	—	<b>PYP-18</b>
3PDT	<b>PT11</b>	<b>PT11QN</b>					<b>PTP-1-3</b>	—	<b>PTP-12</b>	—
4PDT	<b>PT14</b>	<b>PT14QN</b>					<b>PTP-1</b>	<b>PTP-10</b>	—	—

Note: Types PYP-18, PTP-12 and PTP-10 may be cut to any desired length.

Relay	PC terminal socket	Relay hold-down clip		
		Standard	Push-to-test	RC circuit
SPDT DPDT	<b>PT08-0</b>	<b>PYC-P</b>	<b>PYC-P2</b>	<b>PYC-1</b>
3PDT	<b>PT11-0</b>			
4PDT	<b>PT14-0</b>			

# Specifications

www.DataSheet4U.com

## ■ CONTACT DATA

Load	Single contact				Bifurcated contact	
	SPDT		DPDT, 3PDT, 4PDT		DPDT	
	Resistive load (p.f. = 1)	Inductive load (p.f. = 0.4) (L/R = 7 ms)	Resistive load (p.f. = 1)	Inductive load (p.f. = 0.4) (L/R = 7 ms)	Resistive load (p.f. = 1)	Inductive load (p.f. = 0.4) (L/R = 7 ms)
Rated load	15 A at 110 VAC 15 A at 24 VDC	10 A at 110 VAC 7 A at 24 VDC	10 A at 110 VAC 10 A at 24 VDC	7.5 A at 110 VAC 5 A at 24 VDC	5 A at 110 VAC 5 A at 24 VDC	4 A at 110 VAC 4 A at 24 VDC
Contact material	AgCdO					
Carry current	15 A		10 A		7 A	
Max. operating voltage	250 VAC 125 VDC					
Max. operating current	15 A		10 A		7 A	
Max. switching capacity	1,700 VA 360 W	1,100 VA 170 W	1,100 VA 240 W	830 VA 120 W	550 VA 120 W	440 VA 100 W
Min. permissible load	100 mA, 5 VDC				10 mA, 5 VDC	

## ■ COIL DATA

### 1- and 2-pole types – AC

Rated voltage (V)	Rated current (mA)		Coil resistance (Ω)	Coil inductance (ref. value) (H)		Pick-up voltage (% of rated voltage)	Dropout voltage	Maximum voltage	Power consumption (VA, W)
	50 Hz	60 Hz		Armature OFF	Armature ON				
6	214.10	183	12.20	0.04	0.08	80% max.	30% min.	110%	Approx. 1.00 to 1.20 (60 Hz)
12	106.50	91	46	0.17	0.33				
24	53.80	46	180	0.69	1.30				
50	25.70	22	788	3.22	5.66				
100/110	11.70/12.90	10/11	3,750	14.54	24.60				Approx. 0.90 to 1.10 (60 Hz)
110/120	9.90/10.80	8.40/9.20	4,430	19.20	32.10				
200/220	6.20/6.80	5.30/5.80	12,950	54.75	94.07				
220/240	4.80/5.30	4.20/4.60	18,790	83.50	136.40				

### 1- and 2-pole types – DC

Rated voltage (V)	Rated current (mA)	Coil resistance (Ω)	Coil inductance (ref. value) (H)		Pick-up voltage (% of rated voltage)	Dropout voltage	Maximum voltage	Power consumption (VA, W)
			Armature OFF	Armature ON				
6	150	40	0.16	0.33	80% max.	10% min.	110%	Approx. 0.90
12	75	160	0.73	1.37				
24	36.90	650	3.20	5.72				
48	18.50	2,600	10.60	21				
100/110	9.10/10	11,000	45.60	86.20				

- Note: 1. The rated current and coil resistance are measured at a coil temperature of 23°C (73°F) with tolerances of +15%, -20% for AC rated current, and ±15% for DC rated coil resistance.  
 2. The AC coil resistance and inductance are reference values at 60 Hz.  
 3. The performance characteristics are measured at a coil temperature of 23°C (73°F).  
 4. Class B coil insulation is available.

## ■ COIL DATA(continued)

### 3-pole type – AC

Rated voltage (V)	Rated current (mA)		Coil resistance (Ω)	Coil inductance (ref. value) (H)		Pick-up voltage (% of rated voltage)	Dropout voltage	Maximum voltage	Power consumption (VA, W)
	50 Hz	60 Hz		Armature OFF	Armature ON				
6	310	270	6.70	0.03	0.05	80% max.	30% min.	110%	Approx. 1.60 to 2.00 (60 Hz)
12	159	134	24	0.12	0.21				
24	80	67	100	0.44	0.79				
50	38	33	410	2.24	3.87				
100/110	15.90/18.30	13.60/15.60	2,300	10.50	18.50				
120	17.30	14.8	2,450	11.50	20.60				
200/220	10.50/11.60	9.00/9.90	8,650	34.80	59.50				
240	9.40	8	10,400	38.60	74.60				

### 3-pole type – DC

Rated voltage (V)	Rated current (mA)	Coil resistance (Ω)	Coil inductance (ref. value) (H)		Pick-up voltage (% of rated voltage)	Dropout voltage	Maximum voltage	Power consumption (VA, W)
			Armature OFF	Armature ON				
6	234	25.70	0.11	0.21	80% max.	10% min.	110%	Approx. 1.40
12	112	107	0.45	0.98				
24	58.60	410	1.89	3.87				
48	28.20	1,700	8.53	13.90				
100/110	12.70/13	8,500	29.60	54.30				

### 4-pole type – AC

Rated voltage (V)	Rated current (mA)		Coil resistance (Ω)	Coil inductance (ref. value) (H)		Pick-up voltage (% of rated voltage)	Dropout voltage	Maximum voltage	Power consumption (VA, W)
	50 Hz	60 Hz		Armature OFF	Armature ON				
6	386	330	5	0.02	0.04	80% max.	30% min.	110%	Approx. 1.95 to 2.50 (60 Hz)
12	199	170	20	0.10	0.17				
24	93.60	80	78	0.38	0.67				
50	46.80	40	350	1.74	2.88				
100/110	22.50/25.50	19/21.80	1,800	10.50	17.30				
120	19.00	16.40	2,200	9.30	19				
200/220	11.50/13.10	9.80/11.20	6,700	33.10	57.90				
240	11.00	9.50	9,000	33.20	63.40				

### 4-pole type – DC

Rated voltage (V)	Rated current (mA)	Coil resistance (Ω)	Coil inductance (ref. value) (H)		Pick-up voltage (% of rated voltage)	Dropout voltage	Maximum voltage	Power consumption (VA, W)
			Armature OFF	Armature ON				
6	240	25	0.09	0.21	80% max.	10% min.	110%	Approx. 1.50
12	120	100	0.39	0.84				
24	69	350	1.41	2.91				
48	30	1,600	6.39	13.60				
100/110	15/15.90	6,900	32	63.70				

- Note: 1. The rated current and coil resistance are measured at a coil temperature of 23°C (73°F) with tolerances of +15%, -20% for AC rated current, and ±15% for DC rated coil resistance.  
 2. The AC coil resistance and inductance are reference values at 60 Hz.  
 3. The performance characteristics are measured at a coil temperature of 23°C (73°F).  
 4. Class B coil insulation is available.

■ CHARACTERISTICS

Contact resistance	50 mΩ max.	
Operate time	25 ms max.	
Release time	25 ms max.	
Operating frequency	Mechanically	18,000 operations/hour
	Under rated load	1,800 operations/hour
Insulation resistance	100 MΩ min. (at 500 VDC)	
Dielectric strength	2,000 VAC, 50/60 Hz for 1 minute	
	1,000 VAC, 50/60 Hz for 1 minute between contacts of same polarity	
Vibration	Mechanical durability	10 to 55 Hz, 1.00 mm (0.04 in) double amplitude
	Malfunction durability	10 to 55 Hz, 1.00 mm (0.04 in) double amplitude
Shock	Mechanical durability	1,000 m/s <sup>2</sup> (approx. 100 G)
	Malfunction durability	200 m/s <sup>2</sup> (approx. 20 G)
Ambient temperature	Operating	-40° to 70°C (-40° to 158°F)
Humidity	35 to 85% RH	
Service Life	Mechanically	AC: 50 million operations min. (at operating frequency of 18,000 operations/hour) DC: 100 million operations min. (at operating frequency of 18,000 operations/hour)
	Electrically	See "Characteristic Data"
Weight	SPDT, DPDT: Approx. 40 g (1.41 oz), 3PDT: Approx. 50 g (1.76 oz) 4PDT: Approx. 70 g (2.47 oz)	

Note: Data shown are of initial value.

■ CHARACTERISTIC DATA

Maximum switching capacity

LY1

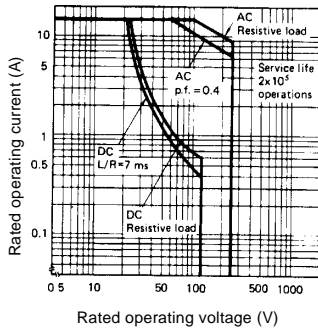

LY2

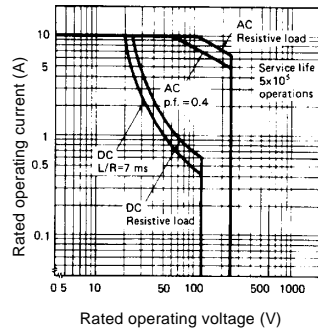

LY3, LY4

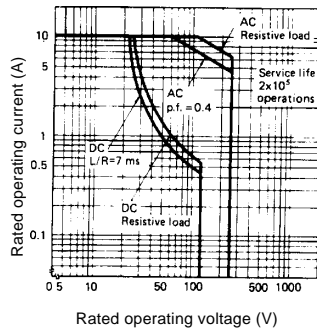

LY2Z

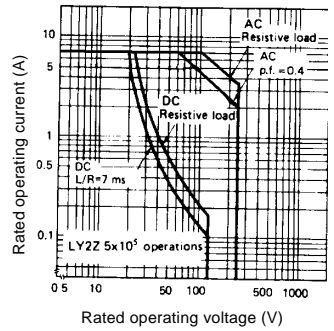

Electrical service life

LY1

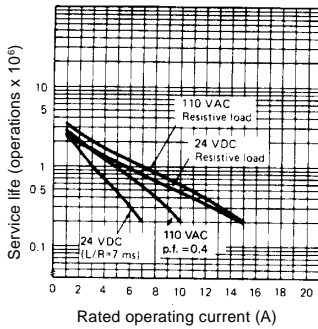

LY2

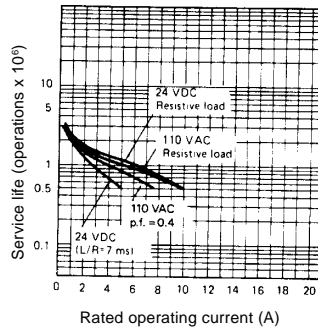

LY3, LY4

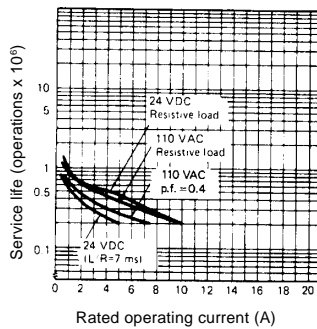

LY2Z

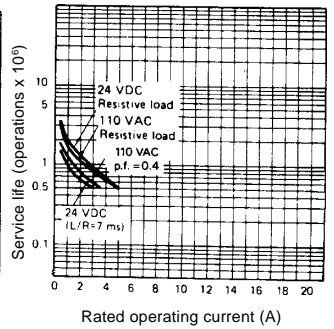

# Dimensions

Unit: mm (inch)

## RELAYS

LY1

Terminal arrangement (Bottom view)

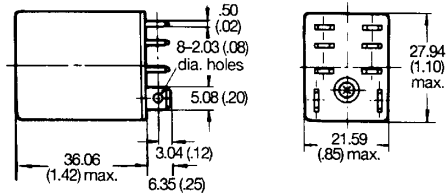

LY2

Terminal arrangement (Bottom view)

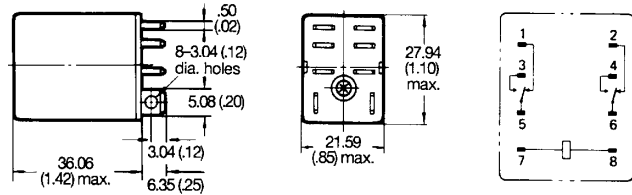

LY3

Terminal arrangement (Bottom view)

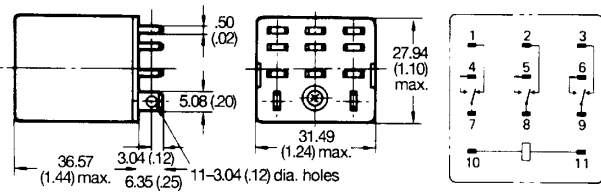

LY4

Terminal arrangement (Bottom view)

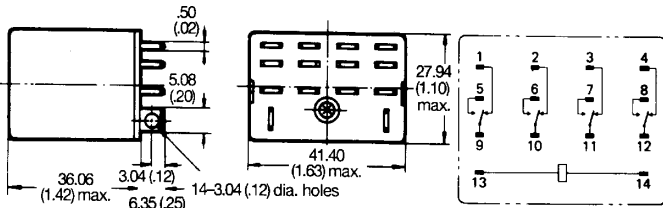

LY1-0, LY2-0, LY3-0, LY4-0

Mounting holes for LY1-0, LY2-0, LY3-0, LY4-0 (Bottom view)

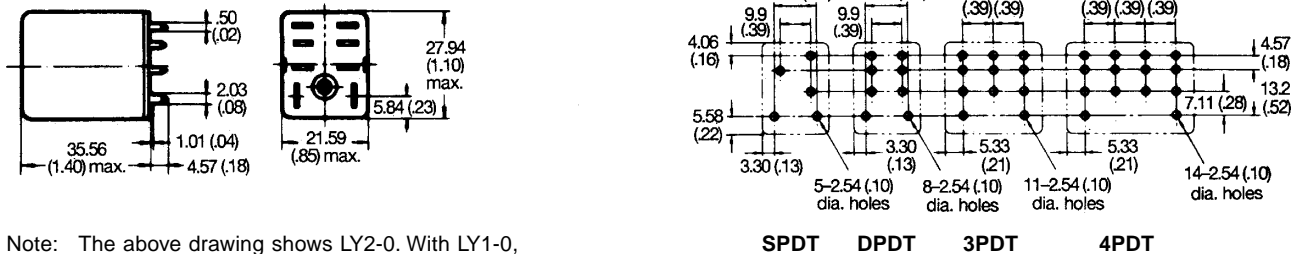

Note: The above drawing shows LY2-0. With LY1-0, dimension "\*" should read as 6.35 (.25).

LY1F, LY2F

Mounting holes

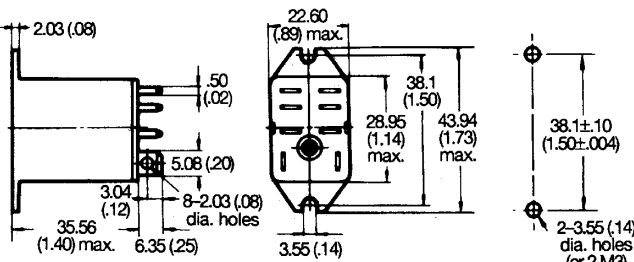

LY3F

Mounting holes

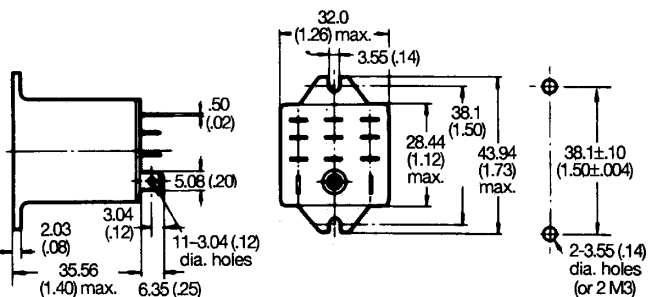

Note: The above drawing shows LY1F. With LY2F, dimension "\*" should read as eight 3.05 mm (0.12 inch) dia. holes.

LY4F

www.DataSheet4U.com

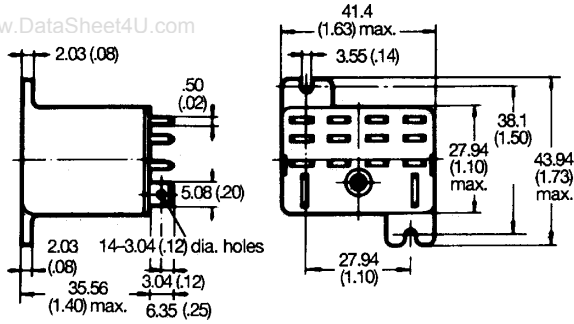

Mounting holes

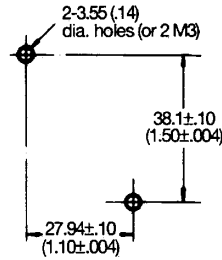

LY1S, LY2S

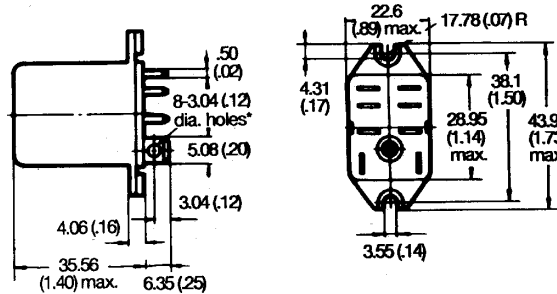

Round hole

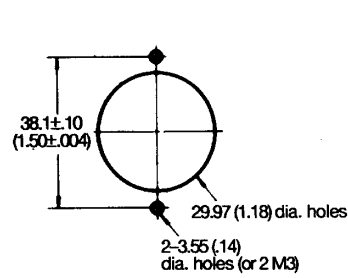

Rectangular hole

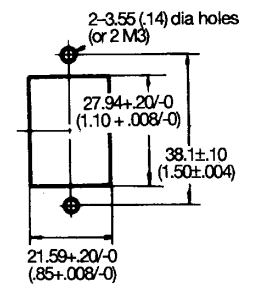

Note: The above drawing shows LY2S-US. With LY1S-US, dimension "\*" should read as eight 2.03 mm (0.08 in) dia. holes.

LY3S

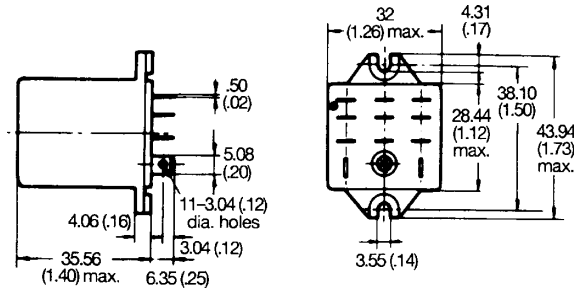

Round hole

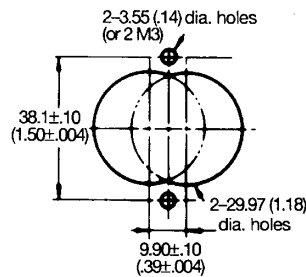

Rectangular hole

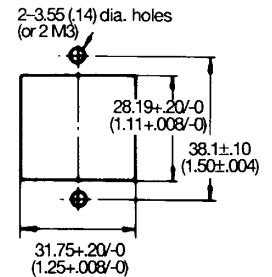

LY4S

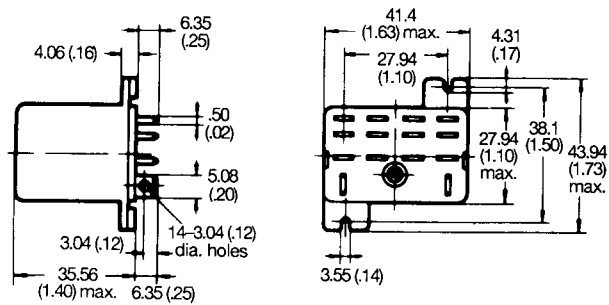

Round hole

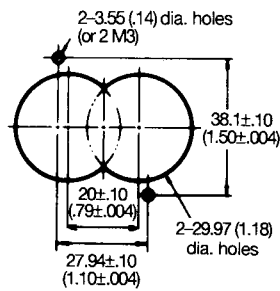

Rectangular hole

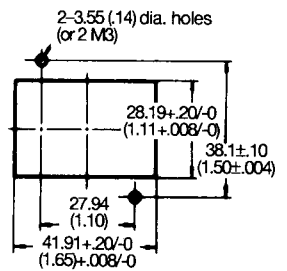

■ ACCESSORIES

Unit: mm (inch)  
www.DataSheet4U.com

Track mounted sockets (UL File No. E87929) (CSA Report No. LR31928)

PTF08A-E

Terminal arrangement/  
mounting holes  
(Top view)

PTF11A

Terminal arrangement/  
mounting holes  
(Top view)

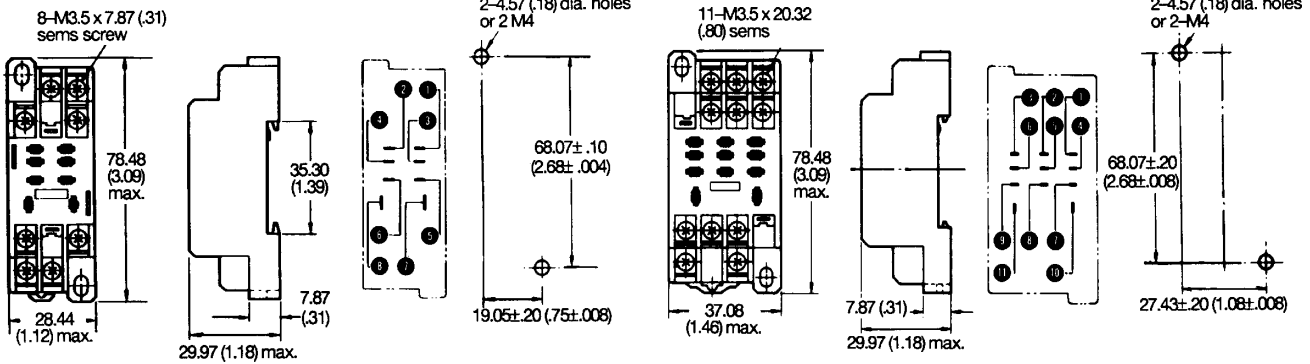

Track mounting sockets (UL File No. E87929) (CSA Report No. LR31928)

PTF14A-E

Terminal arrangement/  
mounting holes  
(Top view)

Mounting height of  
relay with socket  
(Applies to all PTF□A sockets)

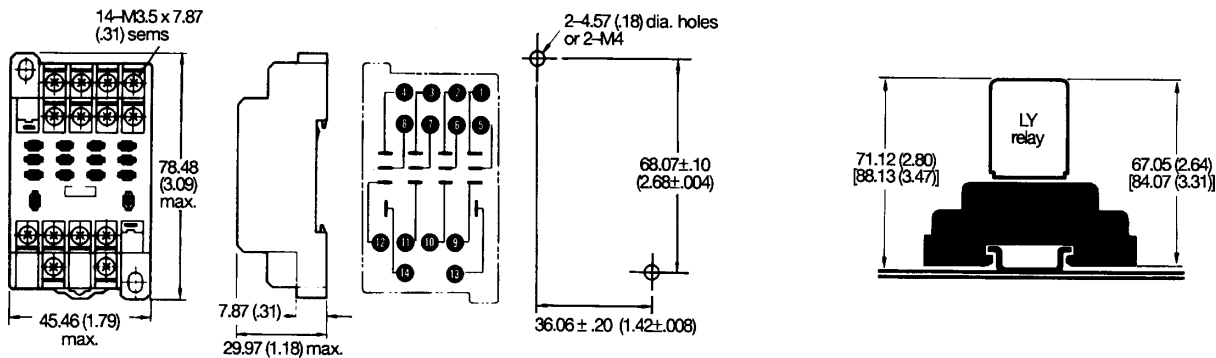

- Note: 1. UL/CSA does not apply to wire wrap (Q) type sockets.  
2. Values in brackets for LY□CR.

Back connecting socket (UL File No. E87929) (CSA Report No. LR31928)

PT08

Terminal arrangement  
(Bottom view)

PT11

Terminal arrangement  
(Bottom view)

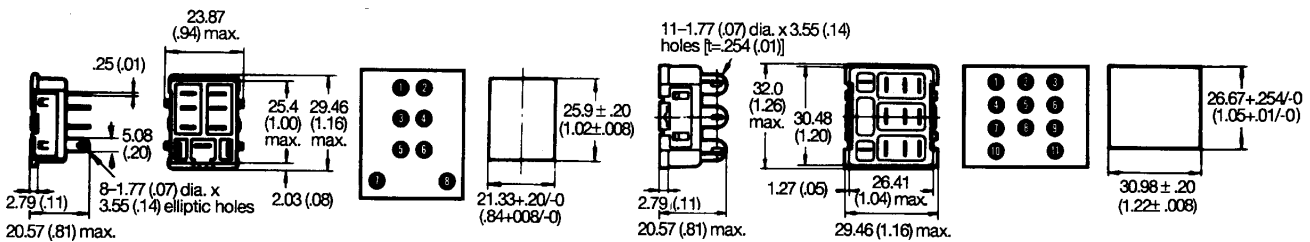



**Back connecting socket (UL File No. E87929) (CSA Report No. LR31928)**

**PT14**

www.DataSheet4U.com

**Terminal arrangement**  
(Bottom view)

**Mounting height of relay with socket**  
(Applies to all PT sockets)

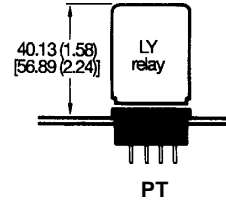
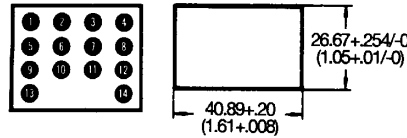
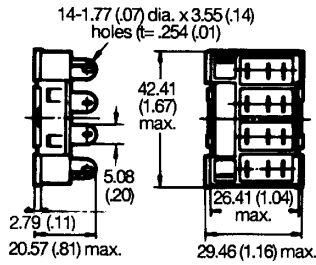

Note: Values in brackets for LY□CR.

**Back connecting socket (UL File No. E87929) (CSA Report No. LR31928)**

**PT08QN**

Panel cut-out and terminal arrangement are the same as Type PT08.

**PT11QN**

Panel cut-out and terminal arrangement are the same as Type PT11.

**PT14QN**

Panel cut-out and terminal arrangement are the same as Type PT14.

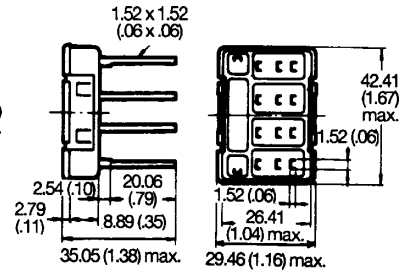
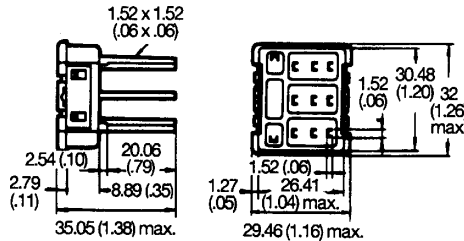
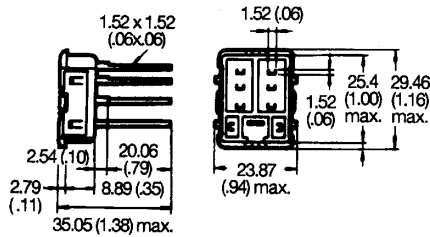

**Back connecting socket (UL File No. E87929) (CSA Report No. LR31928)**

**PT08-0**

Terminal arrangement is the same as Type PT08.

**Mounting holes**  
(Bottom view)

**PT11-0**

Terminal arrangement is the same as Type PT11.

**Mounting holes**  
(Bottom view)

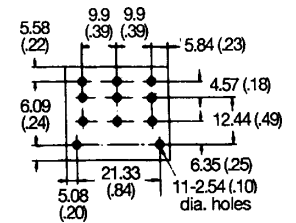
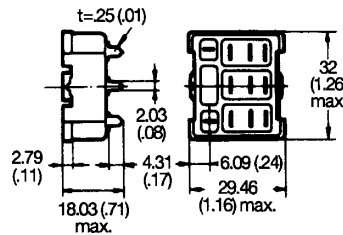
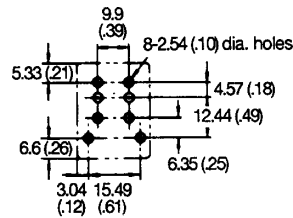
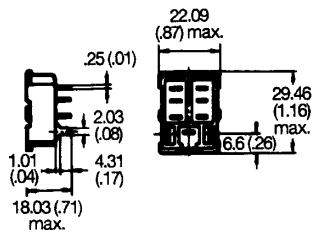

**Back connecting socket (UL File No. E87929) (CSA Report No. LR31928)**

**PT14-0**

Terminal arrangement is the same as Type PT14.

**Mounting holes**  
(Bottom view)

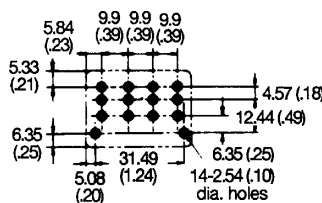
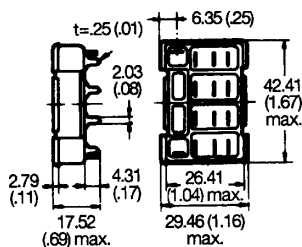

■ ACCESSORIES (continued)

Unit: mm (inch)  
www.DataSheet4U.com

Relay hold-down clips

**PYC-A1**

For PTF□A socket

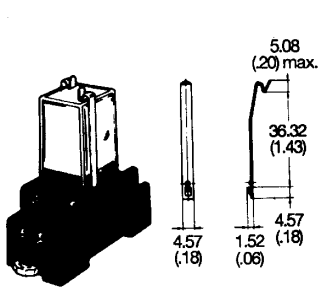

**PYC-S**

For relay mounting plates  
(Applicable to Type PYP-1 and PYP-18 socket mounting plates only.)

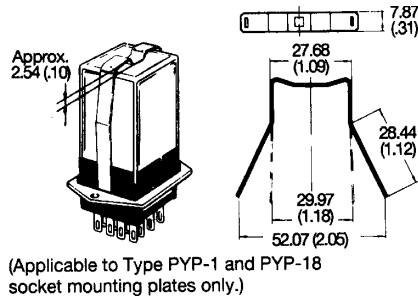

**PYC-P**

For PT□ socket

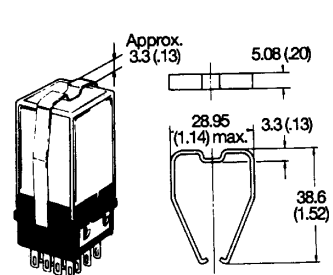

Relay hold-down clips

**PYC-P2**

For push-to-test button type with PT□ socket

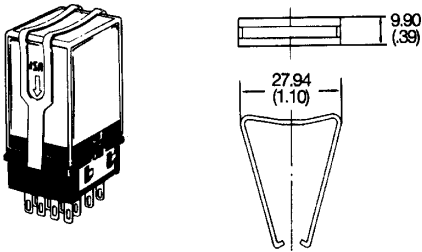

**Y92H-3**

For RC circuit type

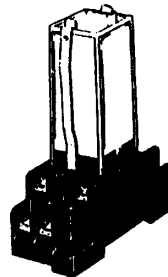

**PYC-1**

For RC circuit type



Mounting track/end plate/spacer

**PFP-100N/PFP-50N mounting track**

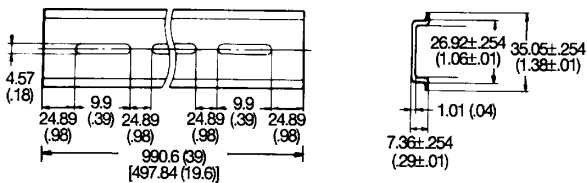

**PFP-M end plate**

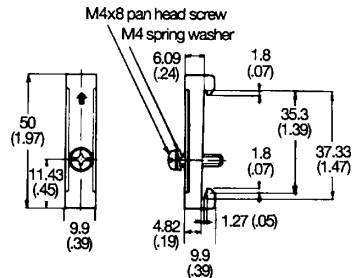

PFP-100N2 mounting track

www.DataSheet4U.com

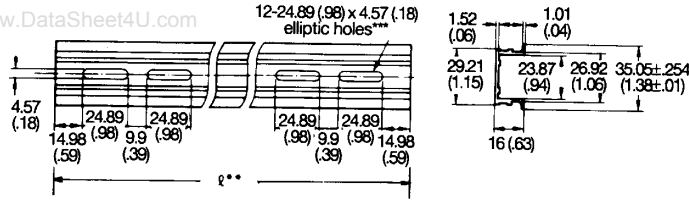

PFP-S spacer

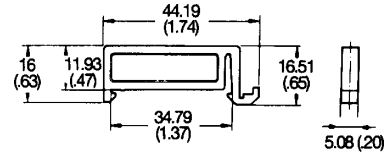

\* This dimension is 14.99 mm (0.59 in) on both ends in the case of PFP-100N, but on one end in the case of PFP-50N.

\*\* L = Length

PFP-50N ..... L = 497.84 mm (19.60 in)

PFP-100N ..... L = 990.60 mm (39.00 in)

PFP-100N2 ..... L = 990.60 mm (39.00 in)

\*\*\* A total of twelve 24.89 x 4.57 mm (0.98 x 0.18 in) elliptical holes are provided, with six holes cut from each end of the track at a pitch of 9.91 (0.39) between holes.

Socket mounting plates [t=1.52 (.06)]

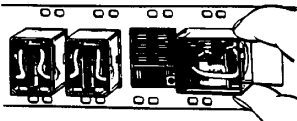

	Number of socket specs.			
Socket needed	1	10	12	18
PT08, PT08QN	PYP-1	-	-	PYP-18
PT11, PT11QN	PTP-1-3	-	PTP-1-2	-
PT14, PT14QN	PTP-1	PTP-10	-	-

PYP-1

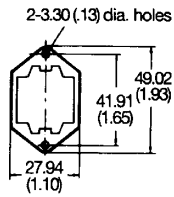

PTP-1-3

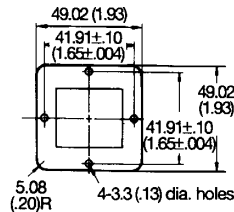

PTP-1

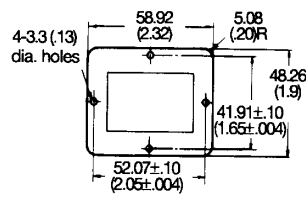

PYP-18

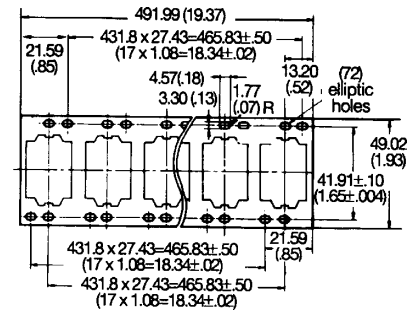

PTP-10

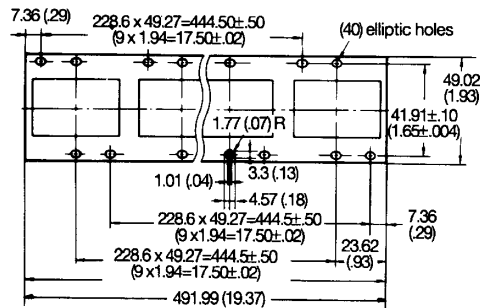

PTP-12

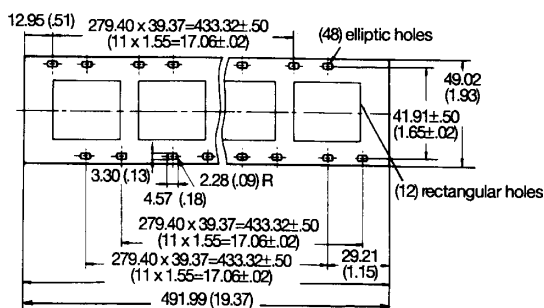

**RELAY OPTIONS**

**LED Indicator**

Specifications and dimensions same as the Standard Type with the following exception. With the LED indicator type, the rated current is approximately 0 to 5.0 mA higher than the Standard Type.

**Terminal arrangement/Internal connections (Bottom view)**

**LY2N**

**DC coil rating type**

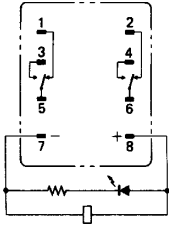

**AC coil rating type**

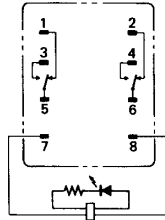

- Note:
1. The coil terminals 10 and 11 of Type LY3N become (-) and (+) and terminals 13 and 14 of Type LY4N become (-) and (+), respectively.
  2. Pay special attention to the polarities when using the DC type.

**Diode Surge Suppression**

Specifications and dimensions same as the Standard Type with the following exception. Ambient operating temperature: -25° to 40°C (-13° to 104°F)

**Without Diode**

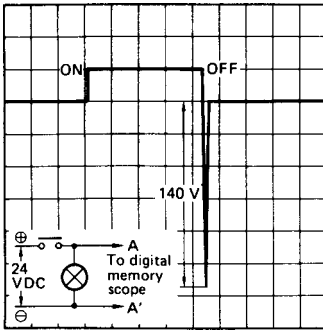

**With Diode**

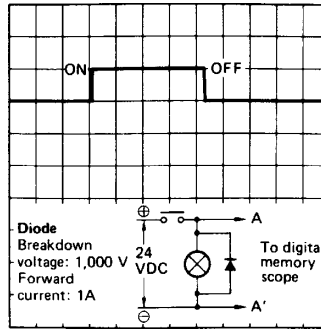

**Terminal arrangement/Internal connections (Bottom view)**

**LY2(N)-D(2)**

**LY2-D**

6, 12, 24, 48  
100/110 VDC

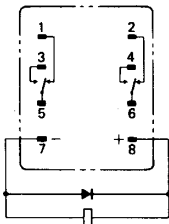

**LY2N-D2**

6, 12, 24, 48 VDC

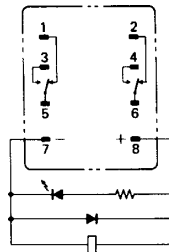

**LY2N-D2**

100/110 VDC

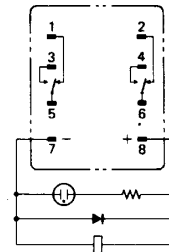

- Note:
1. Pay special attention to the polarities when using the DC type.
  2. The release time is somewhat longer, but satisfies the standard specifications of 25 ms.
  3. The reverse-breakdown voltage of the diode is 1,000 VDC.
  4. Available on DC versions only.

■ RELAY OPTIONS

RC Circuit

www.DataSheet4U.com

Specifications and dimensions same as the Standard Type with the following exceptions.

Characteristic Data

Without RC circuit

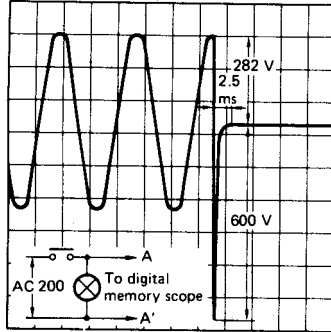

With RC circuit

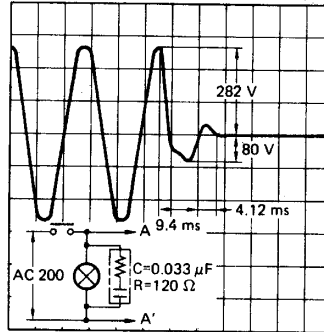

LY1-CR, LY2(Z)-CR

Terminal arrangement/Internal connections (Bottom view)

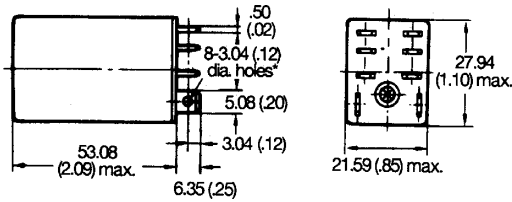

LY1-CR

LY2(Z)-CR

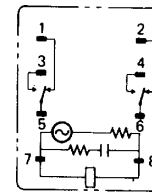
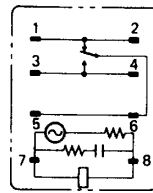

RC circuit  
C: 0.033 μF  
R: 120 Ω

- Note: 1. The above drawing shows LY2(Z)-CR. With LY1-CR, "\*" should read eight 2.03 mm (0.08 in) dia. holes.
- 2. Available on AC versions only.

Push-to-test Button

Specifications and dimensions same as the Standard Type with the following exceptions.

LY□12



LY112, LY212

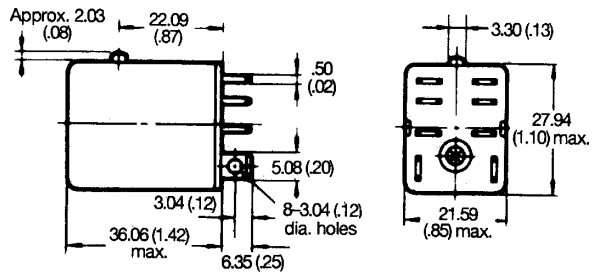

- Note: Type LY112 has the same dimensions and appearances as Type LY212 shown except that dimension "\*" is 2.03 mm (0.08 in) dia. holes

LY312

LY412

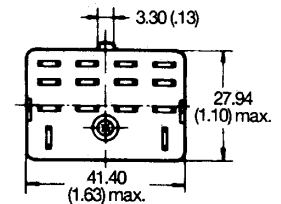
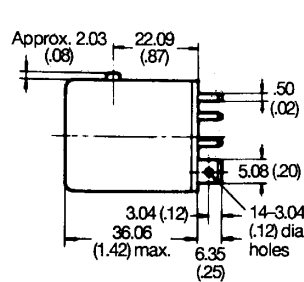
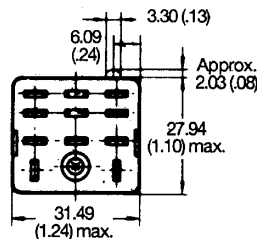
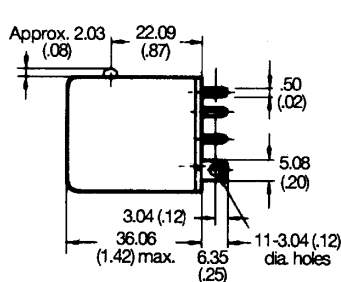

## ■ APPROVALS

### UL recognized type (File No. E41643)

Type	Contact form	Coil ratings	Contact ratings
LY□	SPDT	6 to 240 VAC 6 to 120 VDC	15 A, 240 VAC (Inductive)
			15 A, 28 VDC (Resistive)
			TV-5 (ACTV)
			1/2 HP, 120 VAC (Motor)
			13 A, 120 VAC (Resistive)
LY□	DPDT		12 A, 240 VAC (Inductive)
			10 A, 28 VDC (Resistive)
			TV-3 (ACTV)
			1/2 HP, 120 VAC (Motor)
			10 A, 240 VAC (Inductive)
LY□	3PDT 4PDT		10 A, 28 VDC (Resistive)
			10 A, 240 VAC (Inductive)
			1/2 HP, 240 VAC (Motor)

### CSA certified type (File No. LR31928)

Type	Contact form	Coil ratings	Contact ratings
LY□	SPDT	6 to 240 VAC 6 to 120 VDC	15 A, 120 VAC (Inductive)
			10 A, 240 VAC (Inductive)
			15 A, 28 VDC (Resistive)
			TV-5 (ACTV)
			13 A, 28 VDC (Resistive)
LY□	DPDT		12 A, 120 VAC (Inductive)
			10 A, 240 VAC (Inductive)
			1/3 HP, 120 VAC (Motor)
			TV-3 (ACTV)
			10 A, 240 VAC (Inductive)
LY□	3PDT 4PDT		10 A, 28 VDC (Resistive)
			10 A, 240 VAC (Inductive)

### VDE approved type (File No. 9903 [SPDT, DPDT & 3PDT], File No. 9947 [4PDT])

Type	Contact form	Coil ratings	Contact ratings
LY□-VD	SPDT	6, 12, 24, 50, 110, 220 VAC and 6, 12, 24, 48, 110 VDC	10 A, 220 VAC (Resistive)
			10 A, 28 VDC (Resistive)
			7 A, 220 VAC (Inductive)
			7 A, 28 VDC (Inductive)
			7 A, 220 VAC (Resistive)
LY□-VD	DPDT 3PDT 4PDT		7 A, 28 VDC (Resistive)
			4 A, 220 VAC (Inductive)
			4 A, 28 VDC (Inductive)
			4 A, 28 VDC (Inductive)

### LR (Lloyd's Register) approved type (File No. 562KOB-204523)

Type	Contact form	Coil ratings	Contact ratings
LY□	DPDT 4PDT	6 to 240 VAC 6 to 110 VDC	7.5 A, 230 VAC (Inductive)
			5 A, 24 VDC (Inductive)

### SEV listed type (File No. D7 91/82 [2- & 4-pole], D 91/204a [1- & 3-pole])

Type	Contact form	Coil ratings	Contact ratings
LY□-SV	SPDT	6 to 240 VAC 6 to 110 VDC	15 A, 220 VAC (Resistive)
			15 A, 24 VDC (Resistive)
LY□-SV	DPDT 3PDT 4PDT		10 A, 220 VAC (Resistive)
			10 A, 24 VDC (Resistive)

- Note: 1. The rated values approved by each of the safety standards (e.g., UL, CSA, VDE, and SEV) may be different from the performance characteristics individually defined in this catalog.  
2. In the interest of product improvement, specifications are subject to change.

[www.DataSheet4U.com](http://www.DataSheet4U.com)

---

**OMRON**

**OMRON ELECTRONICS, INC.**

One East Commerce Drive  
Schaumburg, IL 60173

**1-800-55-OMRON**

Cat. No. GC RLY6

9/97

Specifications subject to change without notice.

**OMRON CANADA, INC.**

885 Milner Avenue  
Scarborough, Ontario M1B 5V8

**416-286-6465**

Printed in the U.S.A.

[www.DataSheet4U.com](http://www.DataSheet4U.com)