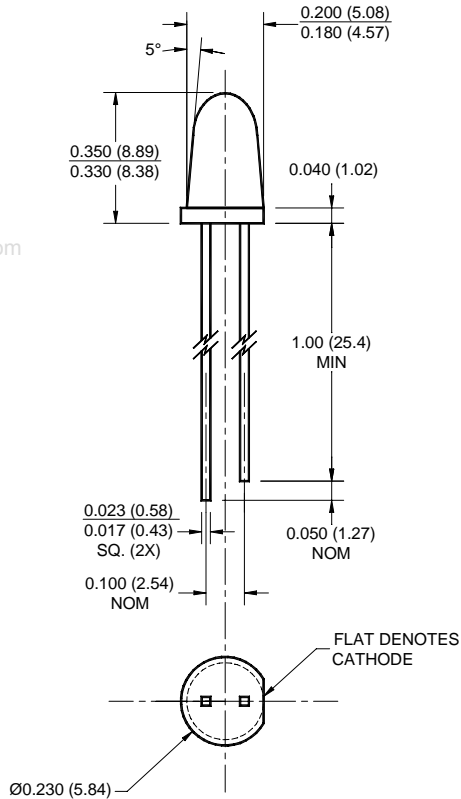


# SUPER BRIGHT T-1 3/4 (5 mm) LED LAMP - Water Clear

## PACKAGE DIMENSIONS



### NOTES:

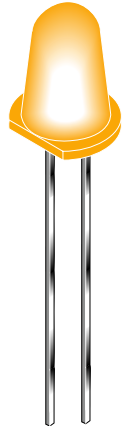
1. Dimensions for all drawings are in inches (mm).
2. Lead spacing is measured where the leads emerge from the package.
3. Protruded resin under the flange is 1.5 mm (0.059") max.

**SUPER ORANGE**  
MV8713 MV8714  
MV8715 MV8716

**MV871X**

## FEATURES

- Popular T-1 3/4 package
- Super high brightness suitable for outdoor applications
- Solid state reliability
- Water clear optics
- Standard 100 mil. lead spacing



## DESCRIPTION

This T-1 3/4 super bright LED has a moderate viewing angle of 12° for concentrated light output. It is made with an AlInGaP LED that emits orange light at 620 nm. It is encapsulated in a water clear epoxy lens package.

## ABSOLUTE MAXIMUM RATINGS ( $T_A = 25^\circ\text{C}$ unless otherwise specified)

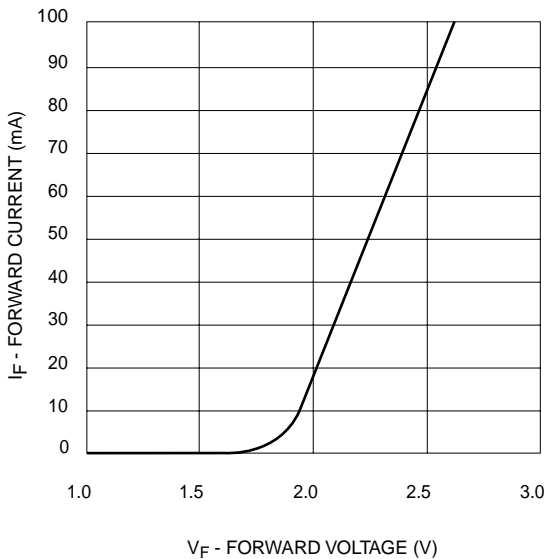
Parameter	Symbol	Rating	Unit
Operating Temperature	$T_{OPR}$	-40 to +100	$^\circ\text{C}$
Storage Temperature	$T_{STG}$	-40 to +100	$^\circ\text{C}$
Lead Soldering Time	$T_{SOL}$	260 for 5 sec	$^\circ\text{C}$
Continuous Forward Current	$I_F$	40	mA
Peak Forward Current ( $f = 1.0 \text{ KHz}$ , Duty Factor = 1/10)	$I_F$	160	mA
Reverse Voltage	$V_R$	5	V
Power Dissipation	$P_D$	100	mW

# SUPER BRIGHT T-1 3/4 (5 mm) LED LAMP - Water Clear

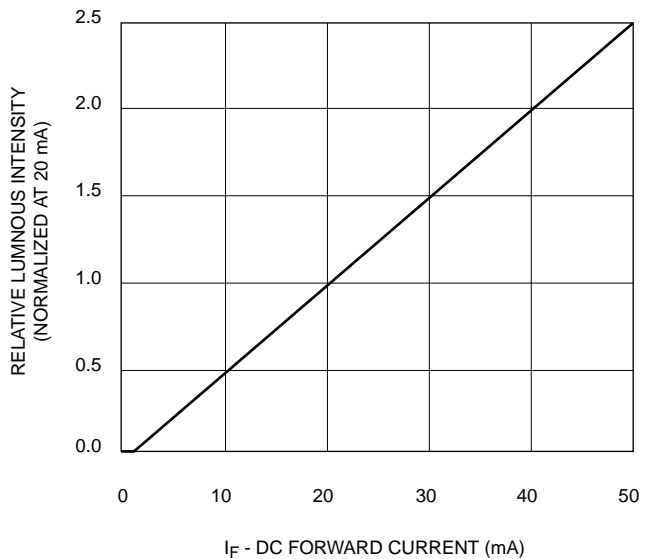
**SUPER ORANGE**                      **MV871X**  
**MV8713 MV8714**  
**MV8715 MV8716**

<b>ELECTRICAL / OPTICAL CHARACTERISTICS</b> (T <sub>A</sub> =25°C)					
Part Number	MV8713	MV8714	MV8715	MV8716	Condition
Luminous Intensity (mcd)					I <sub>F</sub> = 20 mA
Minimum	630	1000	1600	2500	
Typical	940	1500	2400	3500	
Forward Voltage (V)					I <sub>F</sub> = 20 mA
Maximum	2.8	2.8	2.8	2.8	
Typical	2.1	2.1	2.1	2.1	
Wavelength (nm)					I <sub>F</sub> = 20 mA
Peak	620	620	620	620	
Dominant	615	615	615	615	
Spectral Line Half Width (nm)	20	20	20	20	I <sub>F</sub> = 20 mA
Viewing Angle (°)	12	12	12	12	I <sub>F</sub> = 20 mA

## TYPICAL PERFORMANCE CURVES



**Fig. 1 Forward Current vs. Forward Voltage**

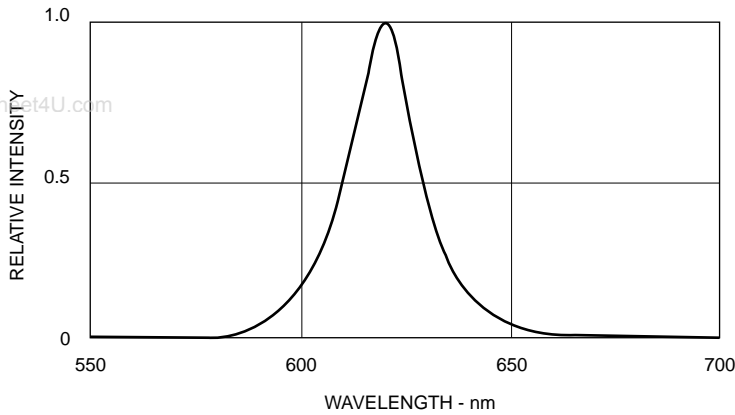


**Fig. 2 Relative Luminous Intensity vs. DC Forward Current**

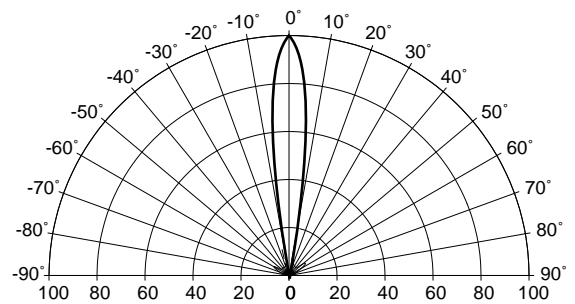
# SUPER BRIGHT T-1 3/4 (5 mm) LED LAMP - Water Clear

**SUPER ORANGE**  
**MV8713 MV8714**  
**MV8715 MV8716**

**MV871X**

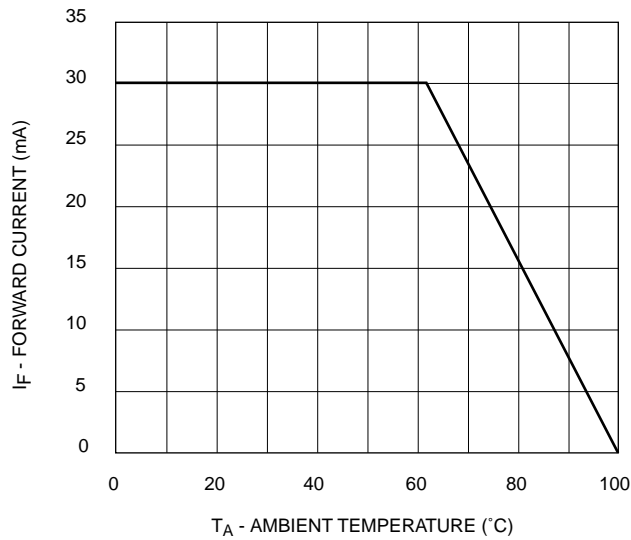


**Fig. 3 Relative Intensity vs Peak Wavelength**



REL. LUMINOUS INTENSITY (%)

**Fig. 4 Radiation Diagram**



**Fig. 5 Current Derating Curve**