



# VNS3NV04D-E

## OMNIFET II fully autoprotected Power MOSFET

### Features

Max On-State resistance (per ch.)	$R_{ON}$	120m $\Omega$
Current limitation (typ)	$I_{LIMH}$	3.5A
Drain-Source clamp voltage	$V_{CLAMP}$	40V

- Linear current limitation
- Thermal shut down
- Short circuit protection
- Integrated clamp
- Low current drawn from input pin
- Diagnostic feedback through input pin
- ESD protection
- Direct access to the gate of the power mosfet (analog driving)
- Compatible with standard power mosfet

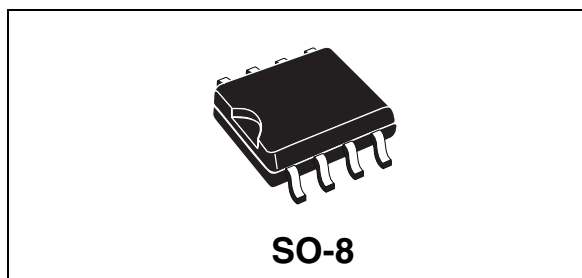

### Description

The VNS3NV04D-E is a device formed by two monolithic OMNIFET II chips housed in a standard SO-8 package. The OMNIFET II are designed in STMicroelectronics VIPower M0-3 Technology: they are intended for replacement of standard Power MOSFETs from DC up to 50KHz applications. Built in thermal shutdown, linear current limitation and overvoltage clamp protects the chip in harsh environments.

Fault feedback can be detected by monitoring the voltage at the input pin.

Table 1. Device summary

Package	Order codes	
	Tube	Tape and Reel
SO-8	VNS3NV04D-E	VNS3NV04DTR-E

---

# Contents

<b>1</b>	<b>Block diagram and pin description</b>	<b>5</b>
<b>2</b>	<b>Electrical specifications</b>	<b>6</b>
2.1	Absolute maximum ratings	6
2.2	Thermal data	7
2.3	Electrical characteristics	7
2.4	Electrical characteristics curves	12
<b>3</b>	<b>Protection features</b>	<b>16</b>
3.1	Overvoltage clamp protection	16
3.2	Linear current limiter circuit	16
3.3	Overtemperature and short circuit protection	16
3.4	Status feedback	16
<b>4</b>	<b>Package and packing information</b>	<b>17</b>
4.1	ECOPACK® packages	17
4.2	SO-8 Package mechanical data	18
4.3	SO-8 Packing information	19
<b>5</b>	<b>Revision history</b>	<b>20</b>

## List of tables

Table 1.	Device summary . . . . .	1
Table 2.	Absolute maximum ratings . . . . .	6
Table 3.	Thermal data. . . . .	7
Table 4.	Off . . . . .	7
Table 5.	On . . . . .	7
Table 6.	Dynamic . . . . .	8
Table 7.	Switching . . . . .	8
Table 8.	Source Drain diode . . . . .	8
Table 9.	Protections (-40°C < T <sub>j</sub> < 150°C, unless otherwise specified) . . . . .	9
Table 10.	Document revision history . . . . .	20

## List of figures

Figure 1.	Block diagram . . . . .	5
Figure 2.	Configuration diagram (top view) . . . . .	5
Figure 3.	Current and voltage conventions . . . . .	6
Figure 4.	Switching time test circuit for resistive load . . . . .	9
Figure 5.	Test circuit for diode recovery times . . . . .	10
Figure 6.	Unclamped inductive load test circuits . . . . .	10
Figure 7.	Input charge test circuit. . . . .	11
Figure 8.	Unclamped inductive waveforms . . . . .	11
Figure 9.	Source-Drain diode forward characteristics . . . . .	12
Figure 10.	Static Drain-Source On resistance . . . . .	12
Figure 11.	Derating curve . . . . .	12
Figure 12.	Static Drain-Source On resistance vs. Input voltage . . . . .	12
Figure 13.	Static Drain-Source On resistance Vs. Input voltage . . . . .	12
Figure 14.	Transconductance . . . . .	12
Figure 15.	Static Drain-Source On resistance Vs. Id . . . . .	13
Figure 16.	Transfer characteristics . . . . .	13
Figure 17.	Turn On current slope. . . . .	13
Figure 18.	Turn On current slope. . . . .	13
Figure 19.	Input voltage Vs. Input charge . . . . .	13
Figure 20.	Turn off Drain source voltage slope . . . . .	13
Figure 21.	Turn off Drain-Source voltage slope . . . . .	14
Figure 22.	Capacitance variations . . . . .	14
Figure 23.	Switching time resistive load. . . . .	14
Figure 24.	Switching time resistive load. . . . .	14
Figure 25.	Output characteristics . . . . .	14
Figure 26.	Normalized On resistance Vs. temperature . . . . .	14
Figure 27.	Normalized Input threshold voltage Vs. temperature . . . . .	15
Figure 28.	Normalized current limit Vs. junction temperature . . . . .	15
Figure 29.	Step response current limit . . . . .	15
Figure 30.	SO-8 package mechanical data & package outline . . . . .	18
Figure 31.	SO-8 tube shipment (no suffix) . . . . .	19
Figure 32.	SO-8 tape and reel shipment (suffix "TR") . . . . .	19

# 1 Block diagram and pin description

Figure 1. Block diagram

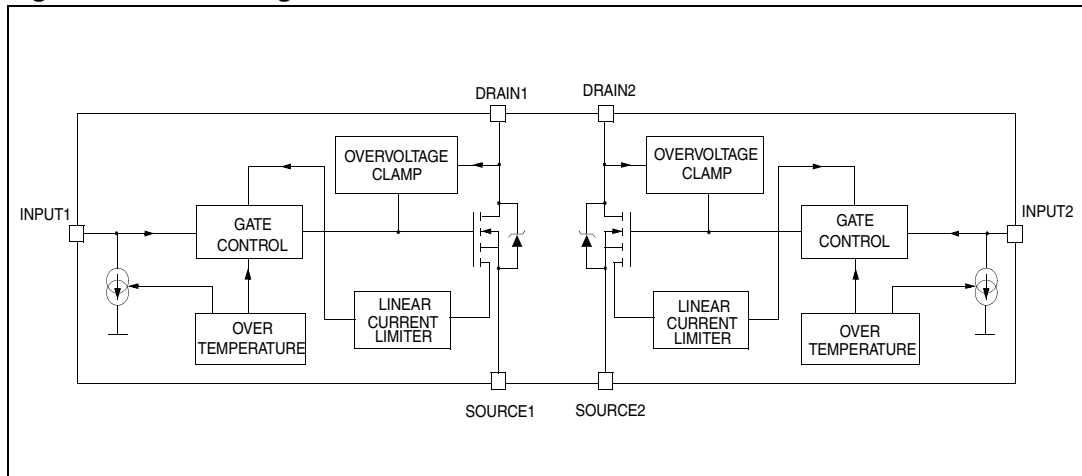
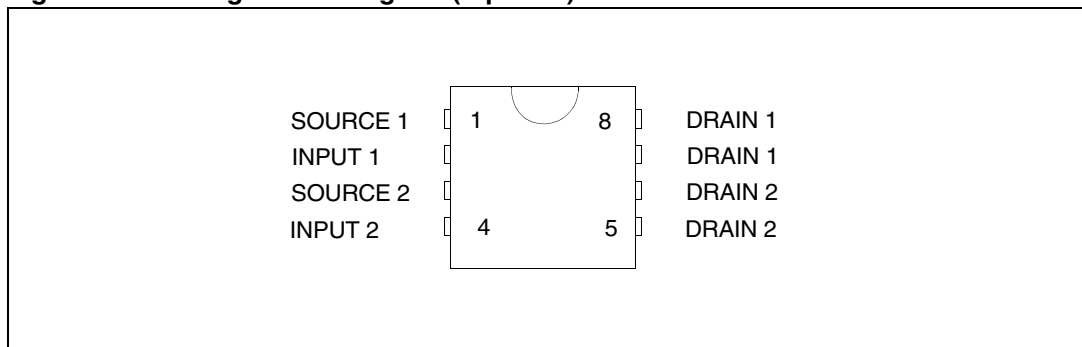
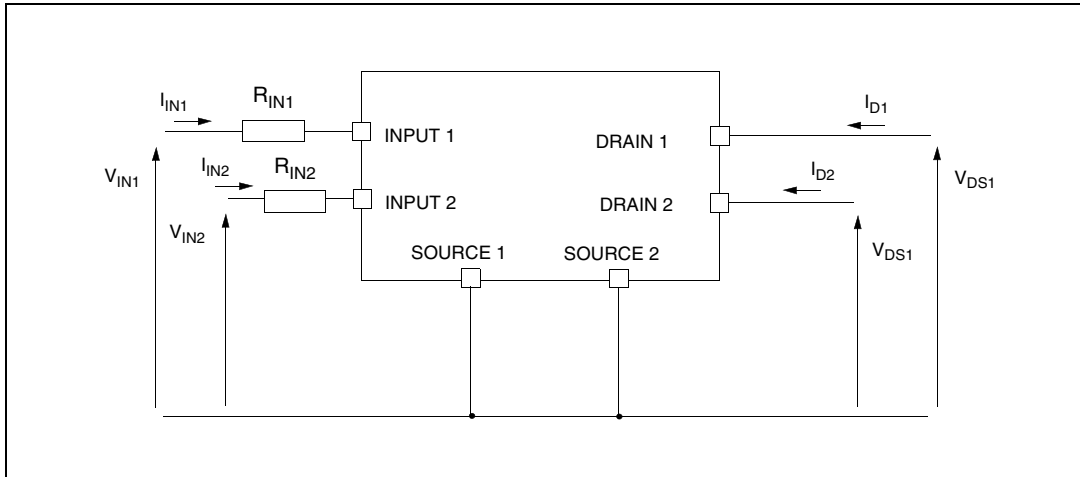

Figure 2. Configuration diagram (top view)



## 2 Electrical specifications

Figure 3. Current and voltage conventions



### 2.1 Absolute maximum ratings

Stressing the device above the rating listed in the “Absolute maximum ratings” table may cause permanent damage to the device. These are stress ratings only and operation of the device at these or any other conditions above those indicated in the operating sections of this specification is not implied. Exposure to Absolute maximum rating conditions for extended periods may affect device reliability. Refer also to the STMicroelectronics SURE program and other relevant quality document.

Table 2. Absolute maximum ratings

Symbol	Parameter	Value	Unit
$V_{DSn}$	Drain-Source Voltage ( $V_{INn}=0V$ )	Internally clamped	V
$V_{INn}$	Input voltage	Internally clamped	V
$I_{INn}$	Input current	+/-20	mA
$R_{IN\ MINn}$	Minimum input series impedance	220	$\Omega$
$I_{Dn}$	Drain current	Internally limited	A
$I_{Rn}$	Reverse DC output current	-5.5	A
$V_{ESD1}$	Electrostatic discharge ( $R=1.5K\Omega$ , $C=100pF$ )	4000	V
$V_{ESD2}$	Electrostatic discharge on output pins only ( $R=330\Omega$ , $C=150pF$ )	16500	V
$P_{tot}$	Total dissipation at $T_c=25^\circ C$	4	$\Omega$
$T_j$	Operating junction temperature	Internally limited	$^\circ C$
$T_c$	Case operating temperature	Internally limited	$^\circ C$
$T_{stg}$	Storage temperature	-55 to 150	$^\circ C$

## 2.2 Thermal data

**Table 3. Thermal data**

Symbol	Parameter	Max value	Unit
$R_{thj-lead}$	Thermal resistance junction-lead (per channel)	30	°C/W
$R_{thj-amb}$	Thermal resistance junction-ambient	80 <sup>(1)</sup>	°C/W

1. When mounted on a standard single-sided FR4 board with 50mm<sup>2</sup> of Cu (at least 35 μm thick) connected to all DRAIN pins of the relative channel

## 2.3 Electrical characteristics

Values specified in this section are for -40°C < T<sub>j</sub> < 150°C, unless otherwise stated.

**Table 4. Off**

Symbol	Parameter	Test Conditions	Min	Typ	Max	Unit
$V_{CLAMP}$	Drain-Source clamp voltage	$V_{IN}=0V$ ; $I_D=1.5A$	40	45	55	V
$V_{CLTH}$	Drain-Source clamp threshold voltage	$V_{IN}=0V$ ; $I_D=2mA$	36			V
$V_{INTH}$	Input threshold voltage	$V_{DS}=V_{IN}$ ; $I_D=1mA$	0.5		2.5	V
$I_{ISS}$	Supply current from input pin	$V_{DS}=0V$ ; $V_{IN}=5V$		100	150	μA
$V_{INCL}$	Input-Source clamp voltage	$I_{IN}=1mA$ $I_{IN}=-1mA$	6 -1.0	6.8	8 -0.3	V
$I_{DSS}$	Zero input voltage drain current ( $V_{IN}=0V$ )	$V_{DS}=13V$ ; $V_{IN}=0V$ ; $T_j=25°C$ $V_{DS}=25V$ ; $V_{IN}=0V$			30 75	μA

**Table 5. On**

Symbol	Parameter	Test conditions	Min	Typ	Max	Unit
$R_{DS(on)}$	Static Drain-Source On resistance	$V_{IN}=5V$ ; $I_D=1.5A$ ; $T_j=25°C$ $V_{IN}=5V$ ; $I_D=1.5A$			120 240	mΩ

Electrical characteristics (continued) ( $T_j=25^\circ\text{C}$ , unless otherwise specified)

Table 6. Dynamic

Symbol	Parameter	Test conditions	Min	Typ	Max	Unit
$g_{fs}^{(1)}$	Forward transconductance	$V_{DD}=13\text{V}; I_D=1.5\text{A}$		5.0		S
$C_{OSS}$	Output capacitance	$V_{DS}=13\text{V}; f=1\text{MHz}; V_{IN}=0\text{V}$		150		pF

Table 7. Switching

Symbol	Parameter	Test conditions	Min	Typ	Max	Unit
$t_{d(on)}$	Turn-on delay time	$V_{DD}=15\text{V}; I_D=1.5\text{A}$ $V_{gen}=5\text{V}; R_{gen}=R_{IN\ MIN}=220\Omega$ (see <a href="#">Figure 4</a> )		90	300	ns
$t_r$	Rise Time			250	750	ns
$t_{d(off)}$	Turn-off delay time			450	1350	ns
$t_f$	Fall time			250	750	ns
$t_{d(on)}$	Turn-on delay time	$V_{DD}=15\text{V}; I_D=1.5\text{A}$ $V_{gen}=5\text{V}; R_{gen}=2.2\ \text{K}\Omega$ (see <a href="#">Figure 4</a> )		0.45	1.35	$\mu\text{s}$
$t_r$	Rise time			2.5	7.5	$\mu\text{s}$
$t_{d(off)}$	Turn-off delay time			3.3	10.0	$\mu\text{s}$
$t_f$	Fall time			2.0	6.0	$\mu\text{s}$
$(di/dt)_{on}$	Turn-on current slope	$V_{DD}=15\text{V}; I_D=1.5\text{A}$ $V_{gen}=5\text{V}; R_{gen}=R_{IN\ MIN}=220\Omega$		4.7		A/ $\mu\text{s}$
$Q_i$	Total input charge	$V_{DD}=12\text{V}; I_D=1.5\text{A}; V_{IN}=5\text{V}$ $I_{gen}=2.13\text{mA}$ (see <a href="#">Figure 7</a> )		8.5		nC

Table 8. Source Drain diode

Symbol	Parameter	Test Conditions	Min	Typ	Max	Unit	
$V_{SD}^{(1)}$	Forward On voltage	$I_{SD}=1.5\text{A}; V_{IN}=0\text{V}$		0.8		V	
$t_{rr}$	Reverse recovery time	$I_{SD}=1.5\text{A}; di/dt=12\text{A}/\mu\text{s}$ $V_{DD}=30\text{V}; L=200\mu\text{H}$ (see <a href="#">Figure 5</a> )		107		ns	
$Q_{rr}$	Reverse recovery charge				37		$\mu\text{C}$
$I_{RRM}$	Reverse recovery current				0.7		A

1. Pulsed: Pulse duration = 300 $\mu\text{s}$ , duty cycle 1.5%



**Table 9. Protections (-40°C < T<sub>j</sub> < 150°C, unless otherwise specified)**

Symbol	Parameter	Test Conditions	Min	Typ	Max	Unit
I <sub>lim</sub>	Drain current limit	V <sub>IN</sub> =5V; V <sub>DS</sub> =13V	3.5	5	7	A
t <sub>dlim</sub>	Step response current limit	V <sub>IN</sub> =5V; V <sub>DS</sub> =13V		10		μs
T <sub>jsh</sub>	Overtemperature shutdown		150	175	200	°C
T <sub>jrs</sub>	Overtemperature reset		135			°C
I <sub>gf</sub>	Fault sink current	V <sub>IN</sub> =5V; V <sub>DS</sub> =13V; T <sub>j</sub> =T <sub>jsh</sub>	10	15	20	mA
E <sub>as</sub>	Single pulse avalanche energy	Starting T <sub>j</sub> =25°C; V <sub>DD</sub> =24V V <sub>IN</sub> =5V R <sub>gen</sub> =R <sub>IN</sub> MIN=220Ω; L=24mH (see <a href="#">Figure 6</a> and <a href="#">Figure 8</a> )	100			mJ

**Figure 4. Switching time test circuit for resistive load**

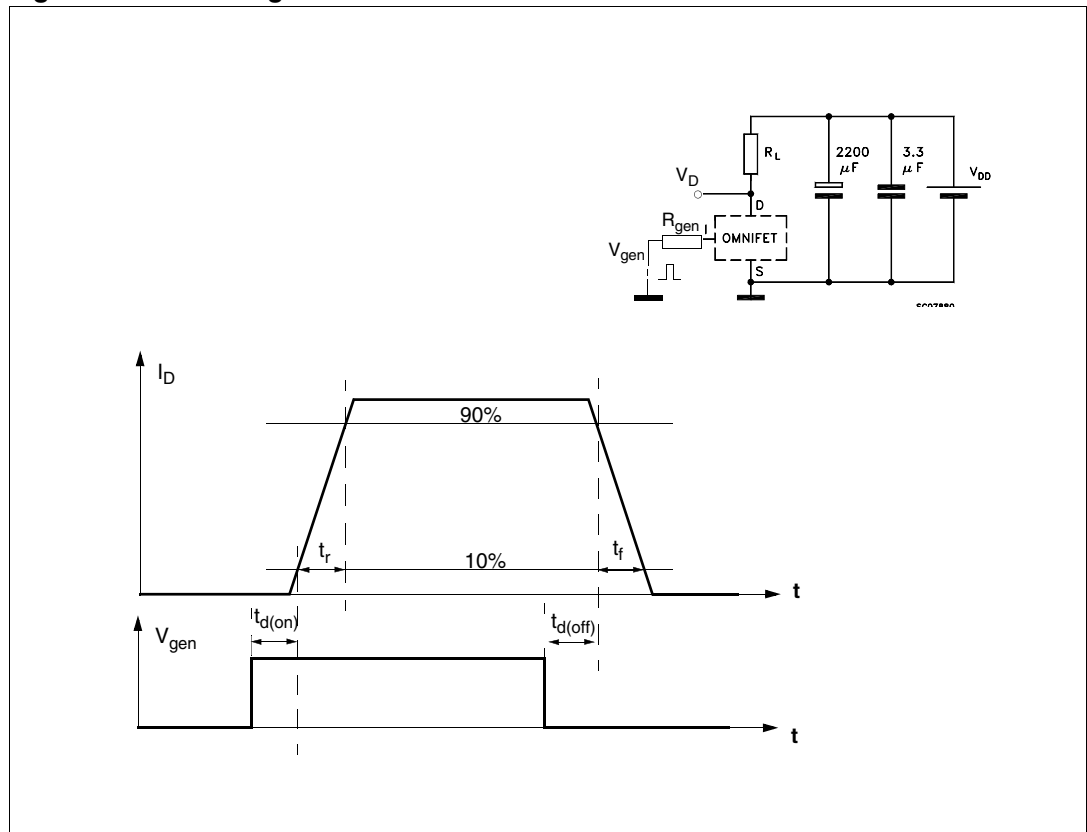

Figure 5. Test circuit for diode recovery times

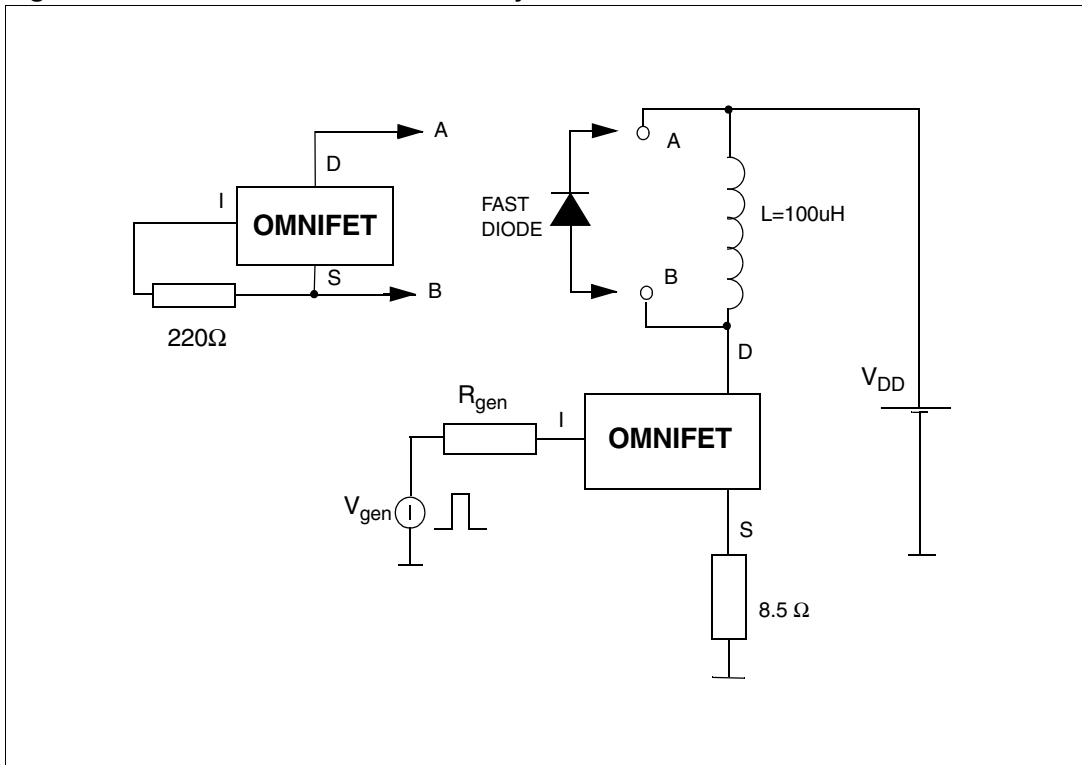

Figure 6. Unclamped inductive load test circuits

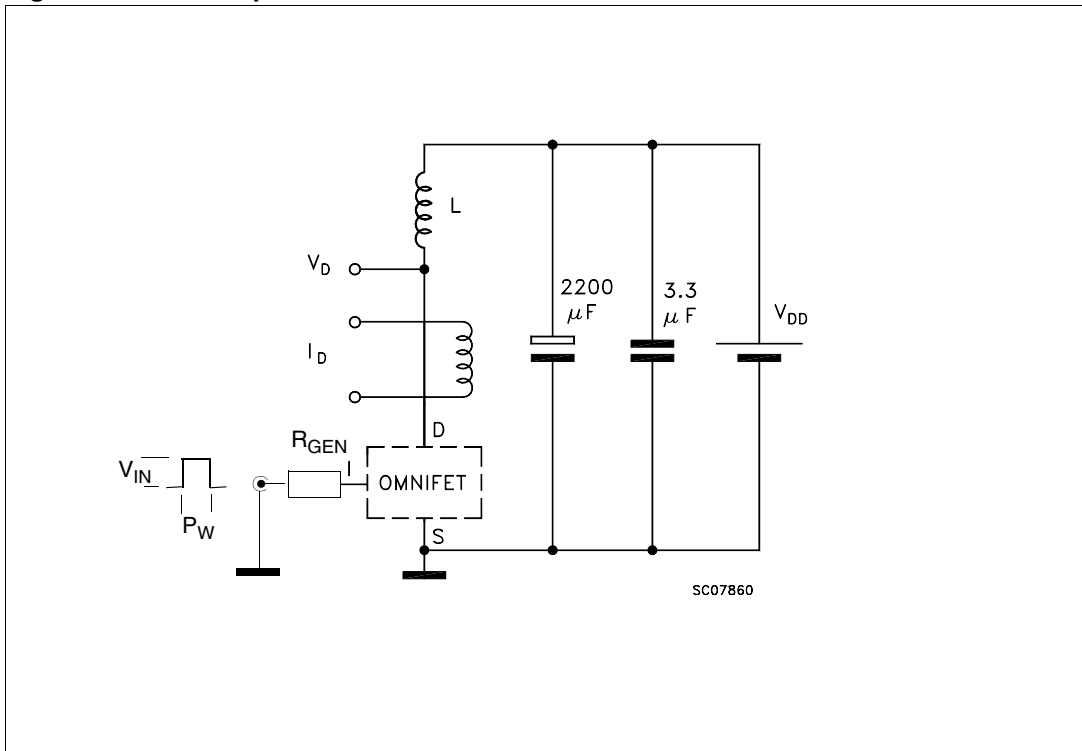

Figure 7. Input charge test circuit

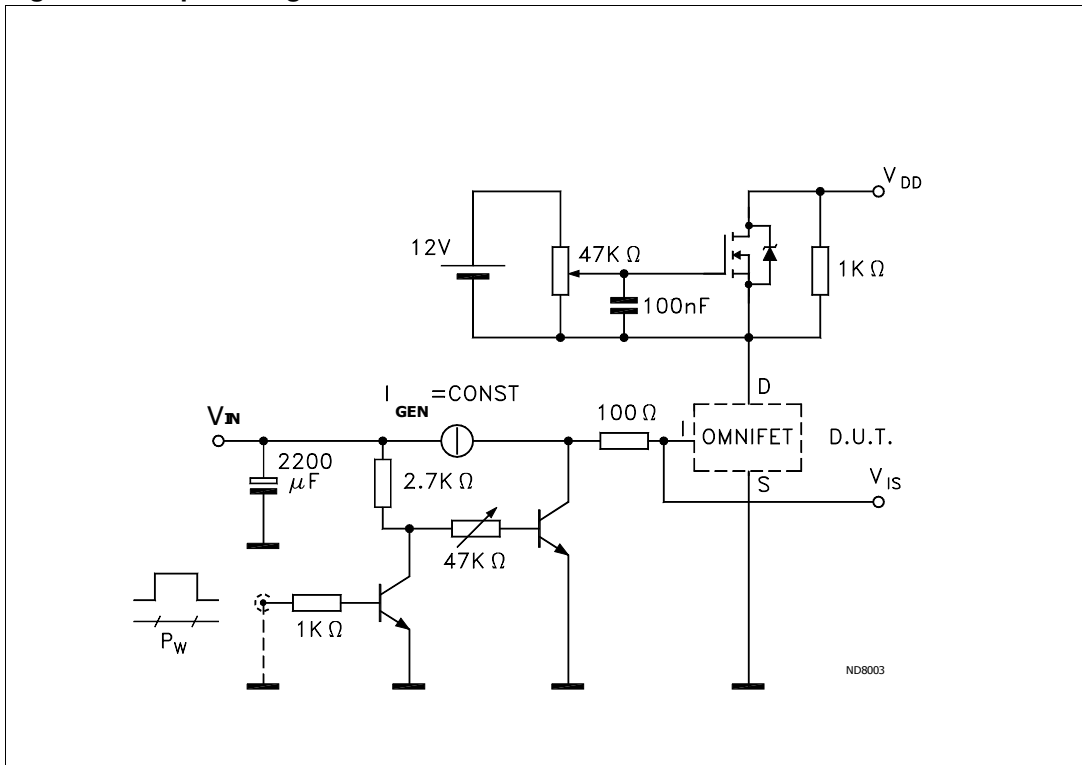
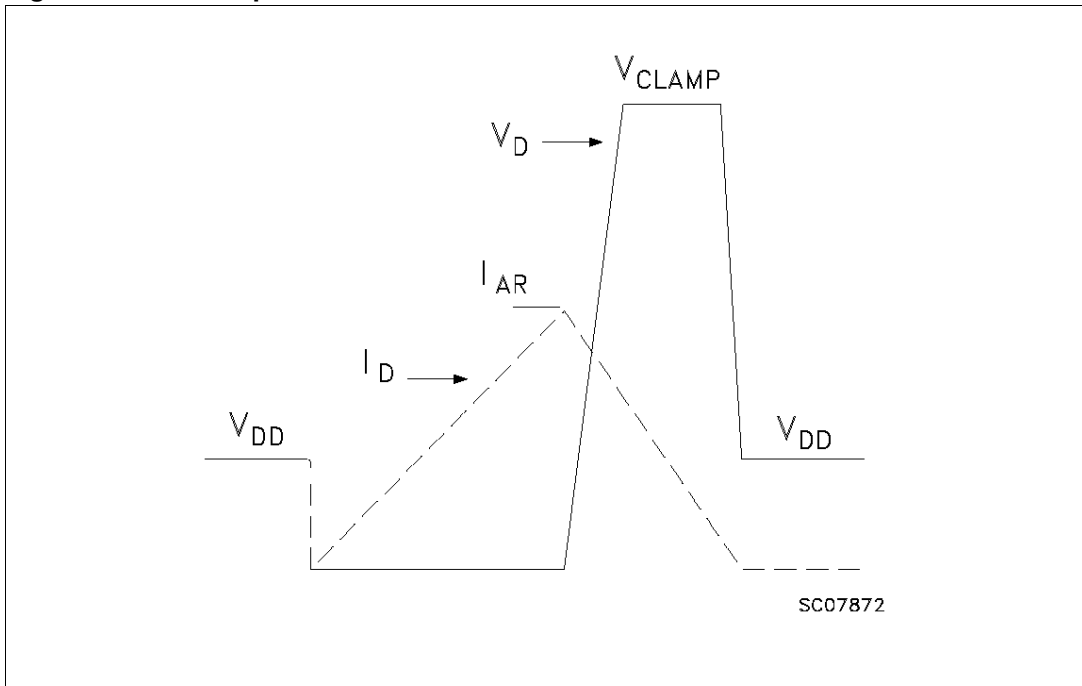
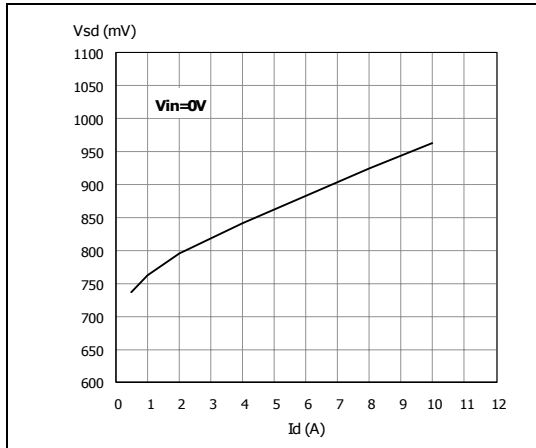

Figure 8. Unclamped inductive waveforms



## 2.4 Electrical characteristics curves

**Figure 9. Source-Drain diode forward characteristics**



**Figure 11. Derating curve**

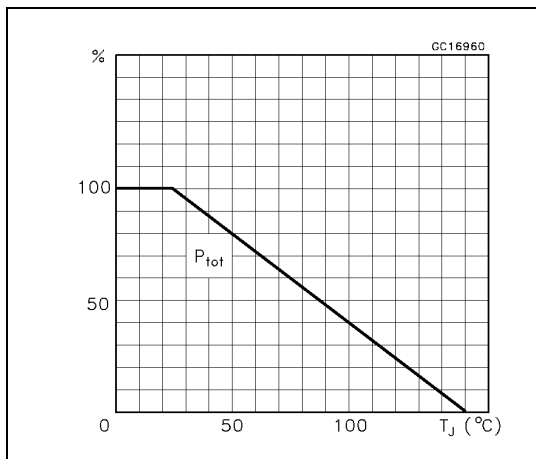

**Figure 13. Static Drain-Source On resistance Vs. Input voltage**

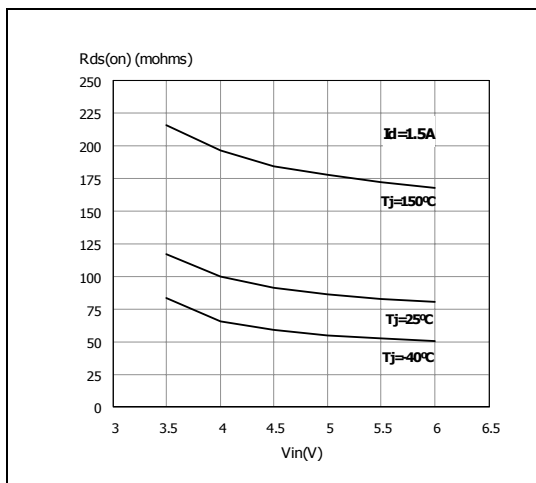

**Figure 10. Static Drain-Source On resistance**

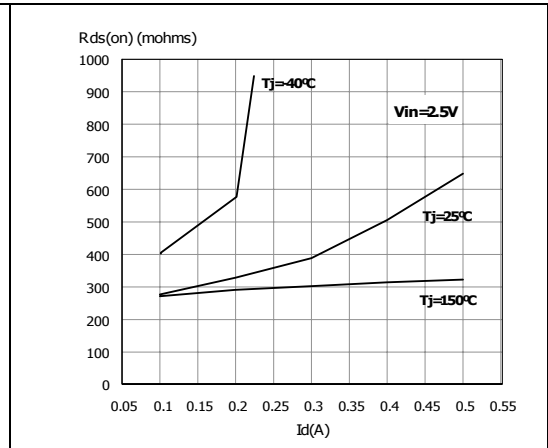

**Figure 12. Static Drain-Source On resistance vs. Input voltage**

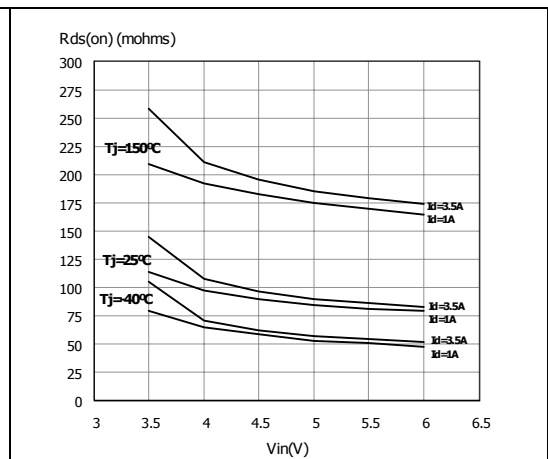

**Figure 14. Transconductance**

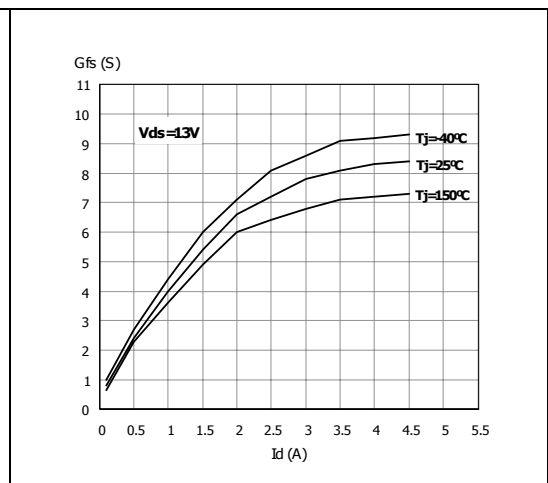

Figure 15. Static Drain-Source On resistance Vs. Id

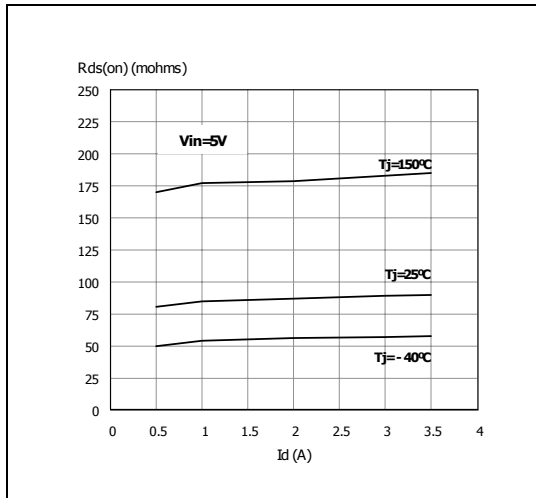

Figure 16. Transfer characteristics

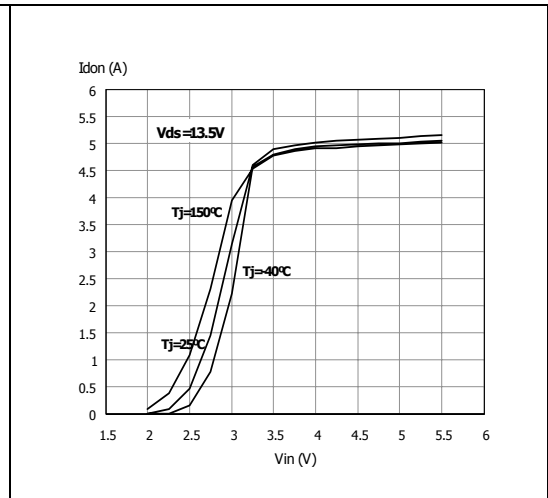

Figure 17. Turn On current slope

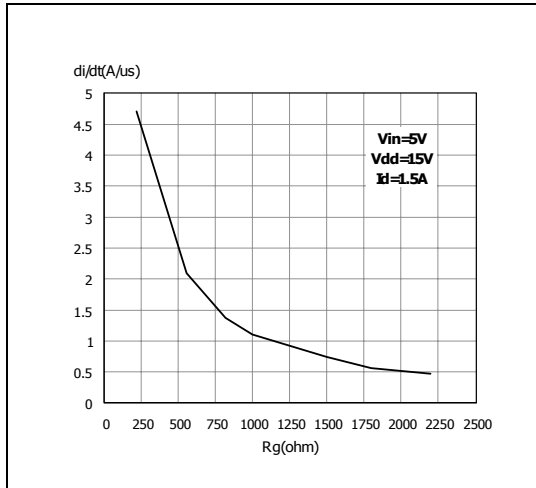

Figure 18. Turn On current slope

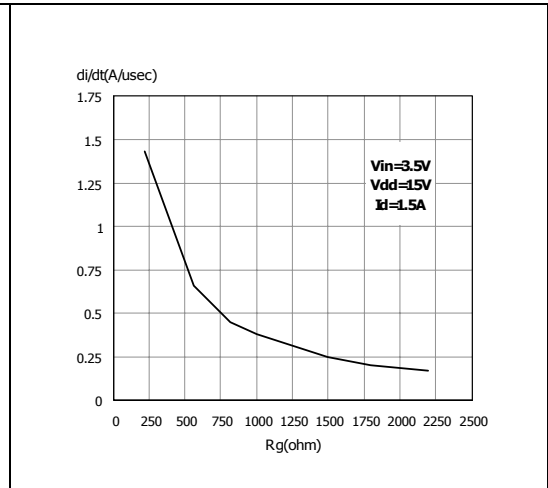

Figure 19. Input voltage Vs. Input charge

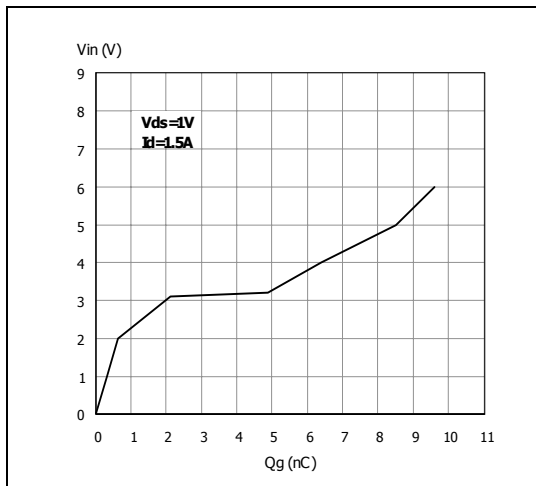
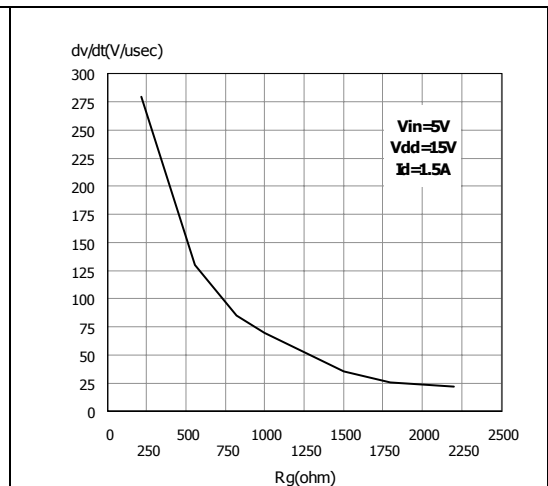
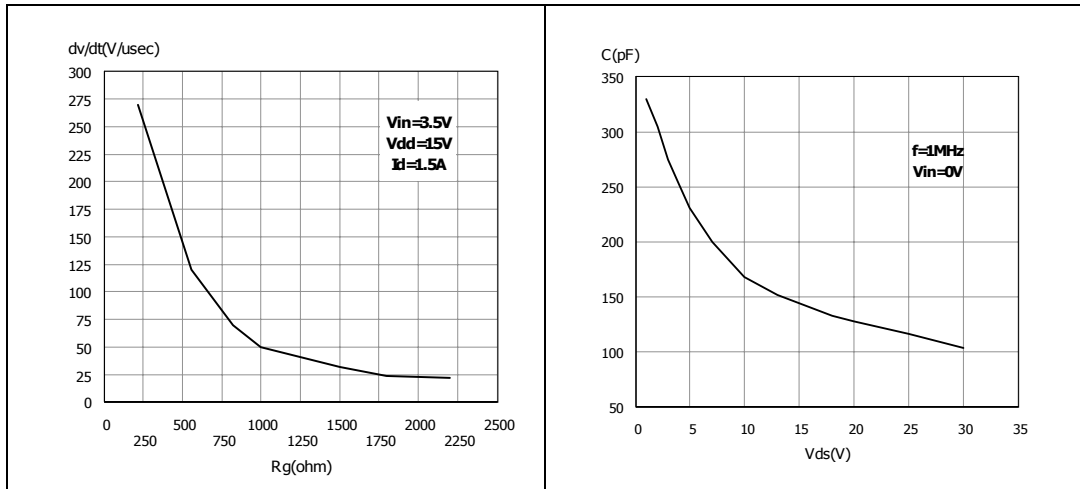

Figure 20. Turn off Drain source voltage slope



**Figure 21. Turn off Drain-Source voltage slope** **Figure 22. Capacitance variations**



**Figure 23. Switching time resistive load** **Figure 24. Switching time resistive load**

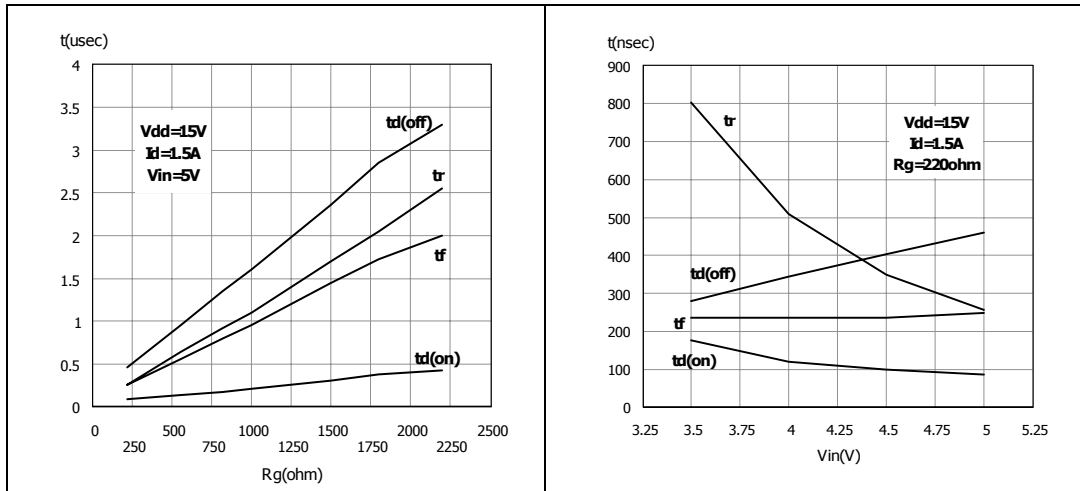

**Figure 25. Output characteristics**

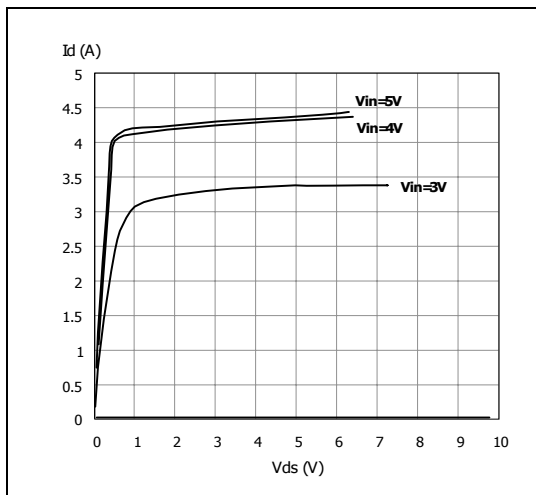

**Figure 26. Normalized On resistance Vs. temperature**

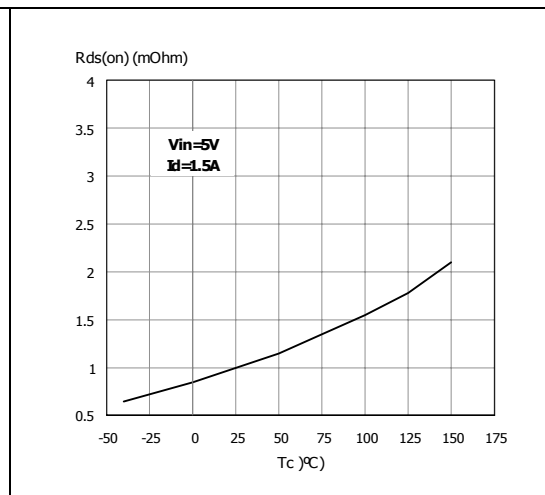

**Figure 27. Normalized Input threshold voltage Vs. temperature**

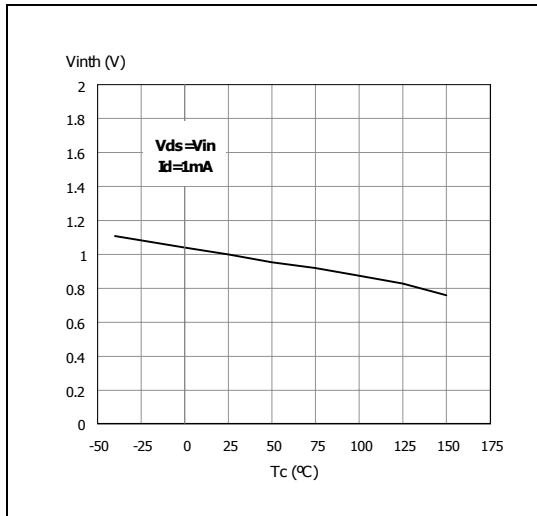

**Figure 28. Normalized current limit Vs. junction temperature**

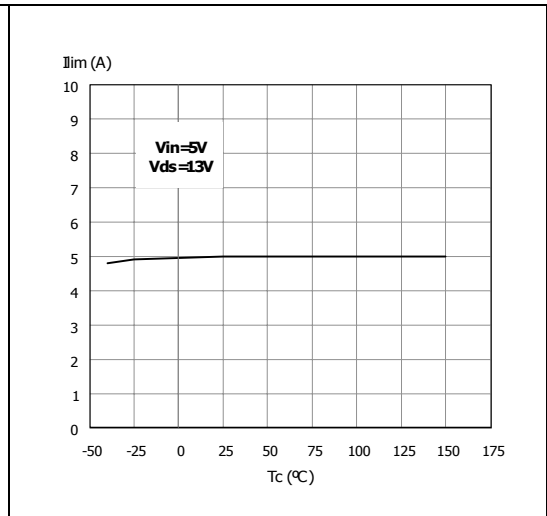

**Figure 29. Step response current limit**

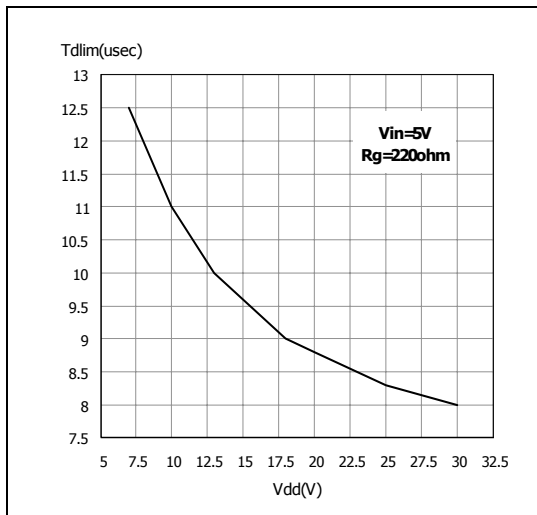

## 3 Protection features

During normal operation, the INPUT pin is electrically connected to the gate of the internal power MOSFET through a low impedance path.

The device then behaves like a standard power MOSFET and can be used as a switch from DC up to 50KHz. The only difference from the user's standpoint is that a small DC current  $I_{SS}$  (typ. 100 $\mu$ A) flows into the INPUT pin in order to supply the internal circuitry.

The device integrates:

### 3.1 Overvoltage clamp protection

Internally set at 45V, along with the rugged avalanche characteristics of the Power MOSFET stage give this device unrivalled ruggedness and energy handling capability. This feature is mainly important when driving inductive loads.

### 3.2 Linear current limiter circuit

Limits the drain current  $I_D$  to  $I_{lim}$  whatever the INPUT pin voltages. When the current limiter is active, the device operates in the linear region, so power dissipation may exceed the capability of the heatsink. Both case and junction temperatures increase, and if this phase lasts long enough, junction temperature may reach the overtemperature threshold  $T_{jsh}$ .

### 3.3 Overtemperature and short circuit protection

These are based on sensing the chip temperature and are not dependent on the input voltage. The location of the sensing element on the chip in the power stage area ensures fast, accurate detection of the junction temperature. Overtemperature cutout occurs in the range 150 to 190 °C, a typical value being 170 °C. The device is automatically restarted when the chip temperature falls of about 15°C below shut-down temperature.

### 3.4 Status feedback

In the case of an overtemperature fault condition ( $T_j > T_{jsh}$ ), the device tries to sink a diagnostic current  $I_{gf}$  through the INPUT pin in order to indicate fault condition. If driven from a low impedance source, this current may be used in order to warn the control circuit of a device shutdown. If the drive impedance is high enough so that the INPUT pin driver is not able to supply the current  $I_{gf}$ , the INPUT pin will fall to 0V. **This will not however affect the device operation: no requirement is put on the current capability of the INPUT pin driver except to be able to supply the normal operation drive current  $I_{SS}$ .**

Additional features of this device are ESD protection according to the Human Body model and the ability to be driven from a TTL Logic circuit.



## 4 Package and packing information

### 4.1 ECOPACK® packages

In order to meet environmental requirements, ST offers these devices in ECOPACK® packages. These packages have a Lead-free second-level interconnect. The category of Second-Level Interconnect is marked on the package and on the inner box label, in compliance with JEDEC Standard JESD97. The maximum ratings related to soldering conditions are also marked on the inner box label.

ECOPACK is an ST trademark. ECOPACK specifications are available at: [www.st.com](http://www.st.com).

## 4.2 SO-8 Package mechanical data

Figure 30. SO-8 package mechanical data & package outline

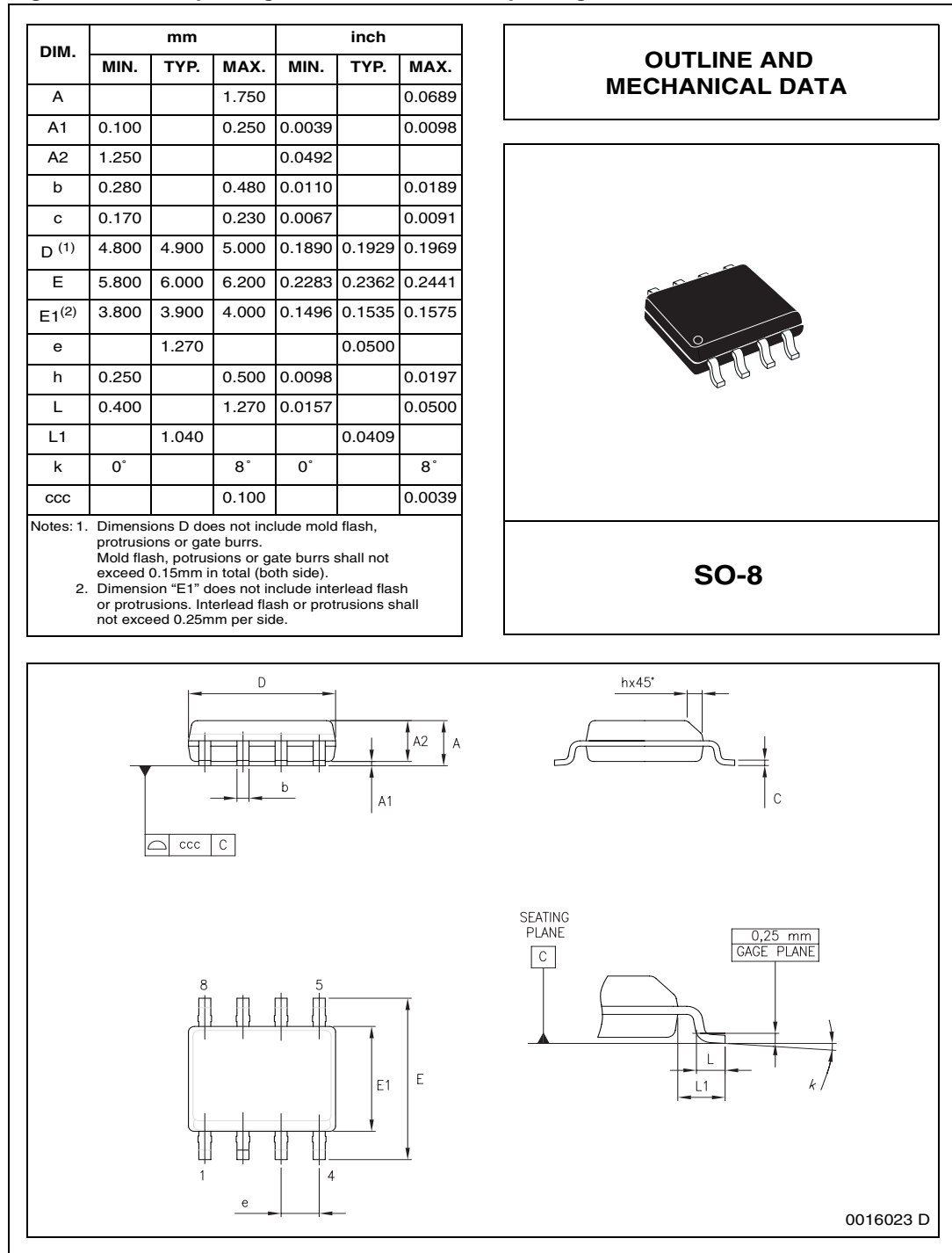

### 4.3 SO-8 Packing information

Figure 31. SO-8 tube shipment (no suffix)

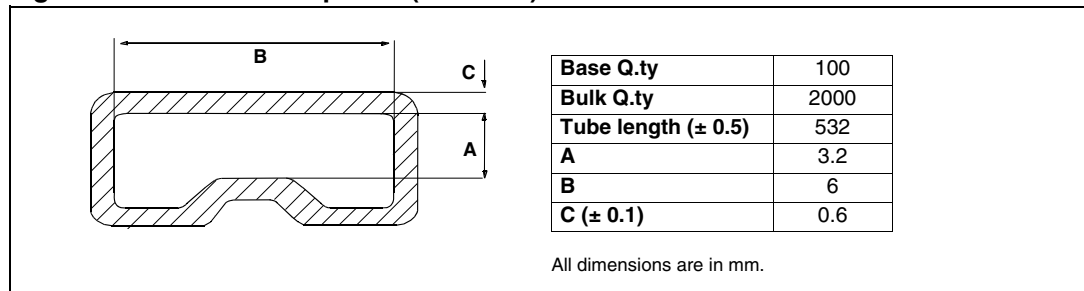
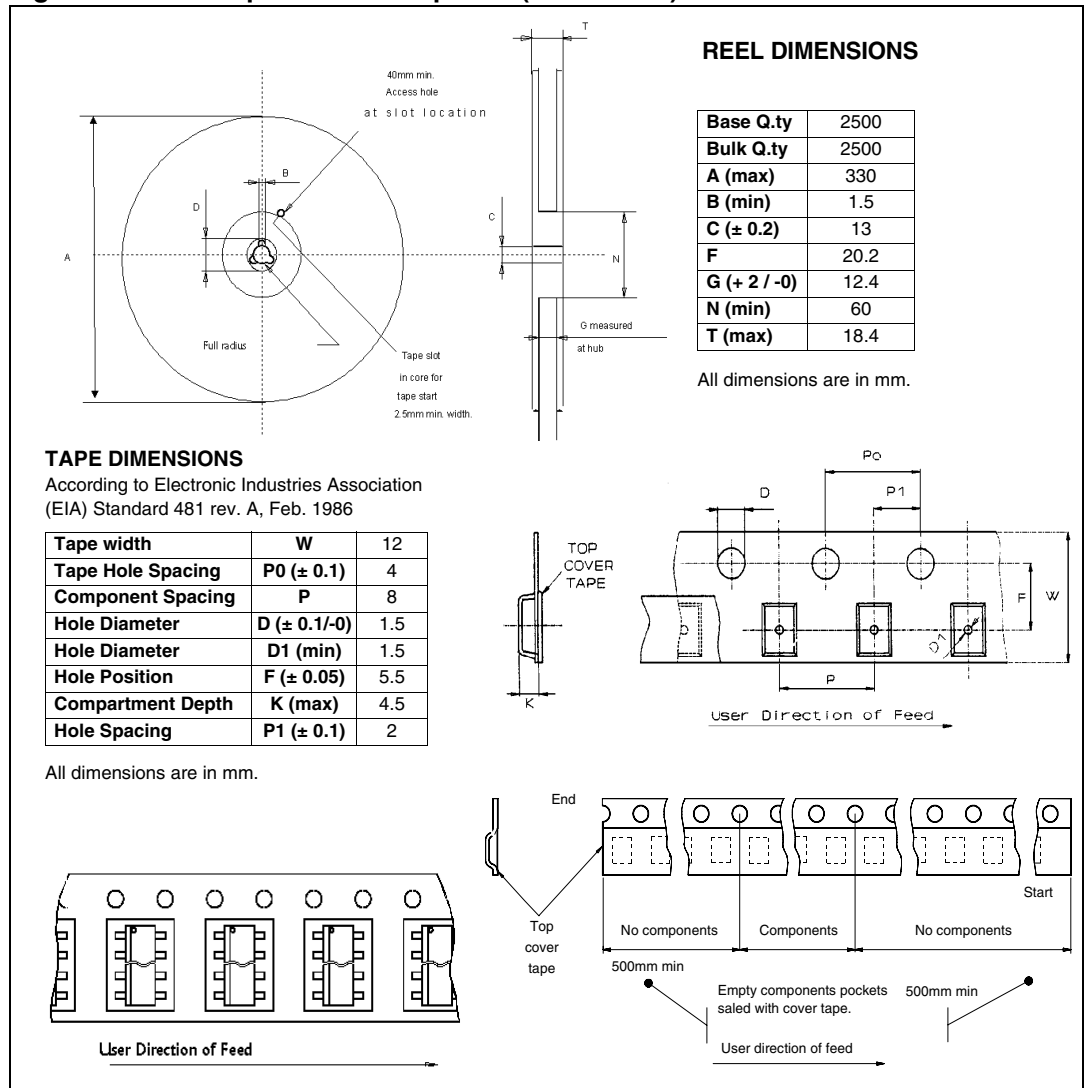

Figure 32. SO-8 tape and reel shipment (suffix "TR")



## 5 Revision history

**Table 10. Document revision history**

Date	Revision	Changes
28-Oct-2005	1	Initial release.
02-Jul-2007	2	Document reformatted and converted into new ST template. <i>Table 4: Off</i> - I <sub>DSS</sub> unit corrected

**Please Read Carefully:**

Information in this document is provided solely in connection with ST products. STMicroelectronics NV and its subsidiaries ("ST") reserve the right to make changes, corrections, modifications or improvements, to this document, and the products and services described herein at any time, without notice.

All ST products are sold pursuant to ST's terms and conditions of sale.

Purchasers are solely responsible for the choice, selection and use of the ST products and services described herein, and ST assumes no liability whatsoever relating to the choice, selection or use of the ST products and services described herein.

No license, express or implied, by estoppel or otherwise, to any intellectual property rights is granted under this document. If any part of this document refers to any third party products or services it shall not be deemed a license grant by ST for the use of such third party products or services, or any intellectual property contained therein or considered as a warranty covering the use in any manner whatsoever of such third party products or services or any intellectual property contained therein.

**UNLESS OTHERWISE SET FORTH IN ST'S TERMS AND CONDITIONS OF SALE ST DISCLAIMS ANY EXPRESS OR IMPLIED WARRANTY WITH RESPECT TO THE USE AND/OR SALE OF ST PRODUCTS INCLUDING WITHOUT LIMITATION IMPLIED WARRANTIES OF MERCHANTABILITY, FITNESS FOR A PARTICULAR PURPOSE (AND THEIR EQUIVALENTS UNDER THE LAWS OF ANY JURISDICTION), OR INFRINGEMENT OF ANY PATENT, COPYRIGHT OR OTHER INTELLECTUAL PROPERTY RIGHT.**

**UNLESS EXPRESSLY APPROVED IN WRITING BY AN AUTHORIZED ST REPRESENTATIVE, ST PRODUCTS ARE NOT RECOMMENDED, AUTHORIZED OR WARRANTED FOR USE IN MILITARY, AIR CRAFT, SPACE, LIFE SAVING, OR LIFE SUSTAINING APPLICATIONS, NOR IN PRODUCTS OR SYSTEMS WHERE FAILURE OR MALFUNCTION MAY RESULT IN PERSONAL INJURY, DEATH, OR SEVERE PROPERTY OR ENVIRONMENTAL DAMAGE. ST PRODUCTS WHICH ARE NOT SPECIFIED AS "AUTOMOTIVE GRADE" MAY ONLY BE USED IN AUTOMOTIVE APPLICATIONS AT USER'S OWN RISK.**

Resale of ST products with provisions different from the statements and/or technical features set forth in this document shall immediately void any warranty granted by ST for the ST product or service described herein and shall not create or extend in any manner whatsoever, any liability of ST.

ST and the ST logo are trademarks or registered trademarks of ST in various countries.

Information in this document supersedes and replaces all information previously supplied.

The ST logo is a registered trademark of STMicroelectronics. All other names are the property of their respective owners.

© 2007 STMicroelectronics - All rights reserved

STMicroelectronics group of companies

Australia - Belgium - Brazil - Canada - China - Czech Republic - Finland - France - Germany - Hong Kong - India - Israel - Italy - Japan - Malaysia - Malta - Morocco - Singapore - Spain - Sweden - Switzerland - United Kingdom - United States of America

[www.st.com](http://www.st.com)

