

NEC**TFT COLOR LCD MODULE**
NL10276BC28-05D**36 cm (14.1 inches), 1024 × 768 pixels, 262,144 colors,
LVDS Interface, High luminance****DESCRIPTION**

NL10276BC28-05D is a TFT (thin film transistor) active matrix color liquid crystal display (LCD) comprising amorphous silicon TFT attached to each signal electrode, a driving circuit and a backlight. NL10276BC28-05D has a built-in backlight and no inverters.

The 36 cm (14.1 inches) diagonal display area contains 1024 × 768 pixels and can display 262,144 colors simultaneously.

FEATURES

- High luminance
- Low reflection
- LVDS interface (Equivalent to THC63LVDF64A of Thine Electronics, Inc.)
- 6-bit digital RGB signals
- Incorporated edge type backlight (two lamps) and lamp holder replaceable

APPLICATIONS

- PC monitors



The information in this document is subject to change without notice.

Please confirm with the delivery specification before starting to design the system.

www.DataSheet4U.com

STRUCTURE AND FUNCTIONS

A color TFT (thin film transistor) LCD module is comprised of a TFT liquid crystal panel structure, LSIs for driving the TFT array, and a backlight assembly. The TFT panel structure is created by sandwiching liquid crystal material in the narrow gap between a TFT array glass substrate and a color filter glass substrate. After the driver LSIs are connected to the panel, the backlight assembly is attached to the backside of the panel.

RGB (red, green, blue) data signals from a source system is modulated into a form suitable for active matrix addressing by the onboard signal processor and sent to the driver LSIs which in turn addresses the individual TFT cells.

Acting as an electro-optical switch, each TFT cell regulates light transmission from the backlight assembly when activated by the data source. By regulating the amount of light passing through the array of red, green, and blue dots, color images are created with clarity.

BLOCK DIAGRAM

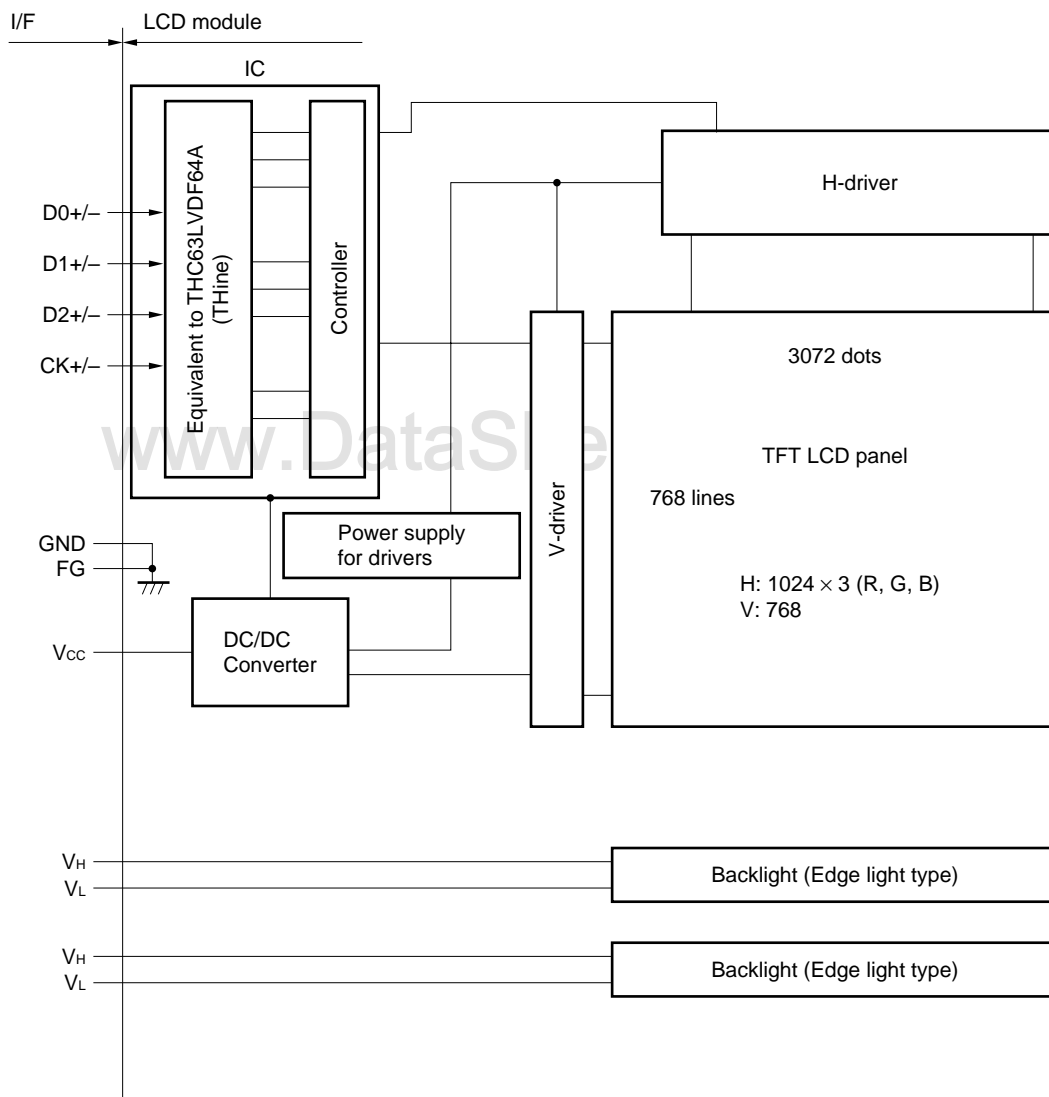

Note GND is connected to FG (Frame Ground) inside the LCD module.

OUTLINE OF CHARACTERISTICS (at room temperature)

Items	Description
Display area	285.696 (H) × 214.272 (V) mm
Drive system	a-Si TFT active matrix
Display colors	262,144 colors
Number of pixels	1024 × 768 pixels
Pixel arrangement	RGB vertical stripe
Pixel pitch	0.279 (H) × 0.279 (V) mm
Module size	330.0 (H) × 255.0 (V) × 17.3 typ. (D) mm
Weight	1150 g (typ.)
Contrast ratio	150 : 1 (typ.)
Viewing angle (more than the contrast ratio of 10 : 1)	<ul style="list-style-type: none"> • Horizontal: 50° (typ., left side, right side) • Vertical : 20° (typ., up side). 35° (typ., down side)
Designed viewing direction	<ul style="list-style-type: none"> • Best contrast angle: down side 5° • Wider viewing angle without image reversal : up side (12 o'clock) • Optimum grayscale (r = 2.2): perpendicular
Color gamut	40 % (typ., at center, to NTSC)
Response time	11 ms (typ.), "white 100 %" to "Black 10%"
Luminance	200 cd/m ² (typ., at IL = 6.1 mArms/lamp)
Signal system	RGB 6-bit signals, Synchronous signals (Hsync, Vsync), Dot clock (CLK) LVDS interface (Equivalent to THC63LVDF64A, Thine Electronics, Inc.)
Supply voltage	5 V (Logic, LCD driving)
Backlight	Edge light type: Two cold cathode fluorescent lamps in a holder <ul style="list-style-type: none"> • Lamp holder: type No.141 LHS08
Power consumption	9.5 W (typ., at IL = 6.1 mArms/lamp)

GENERAL SPECIFICATIONS

Items	Description	Unit
Module size	330 ± 0.5 (H) × 255.0 ± 0.5 (V) × 18.5 max. (D)	mm
Display area	285.696 (H) × 214.272 (V) [Diagonal display area: 36 cm (14.1 inches)]	mm
Number of pixels	1024 × 3 (H) × 768 (V)	pixel
Dot pitch	0.093 (H) × 0.279 (V)	mm
Pixel pitch	0.279 (H) × 0.279 (V)	mm
Pixel arrangement	RGB (Red, Green, Blue) vertical stripe	–
Display colors	262,144 (RGB, 6 bit)	color
Weight	1150 (typ.), 1300 (max.)	g

ABSOLUTE MAXIMUM RATINGS

Parameters	Symbol	Rating	Unit	Remarks
Supply voltage	V _{CC}	–0.3 to +6.0	V	T _a = 25°C
Logic input voltage	V _i	–0.3 to V _{CC} + 0.3	V	
Lamp voltage	V _L	2000	V _{rms}	
Storage temp.	T _{ST}	–20 to +60	°C	–
Operating temp.	T _{OP}	0 to +50	°C	Module surface Note 1
Relative Humidity (RH)	Note 2	≤ 95%	%	T _a ≤ 40°C
		≤ 85%	%	40 < T _a ≤ 50°C
Absolute humidity	Note 2	Absolute humidity shall not exceed T _a = 50°C, 85% relative humidity level.	g/m ³	T _a > 50°C

- Notes**
1. Measured at the panel surface (including selfheat)
 2. No condensation

ELECTRICAL CHARACTERISTICS

(1) Logic, LCD driving

T_a = 25°C

Parameters	Symbols	Min.	Typ.	Max.	Unit	Remarks
Supply voltage	V _{CC}	4.75	5.0	5.25	V	–
Ripple voltage	V _{RP}	–	–	100	mV	for V _{CC}
Differential input “L” Threshold voltage	V _{TL}	–100	–	–	mV	V _{CM} = 1.2 V V _{CM} : Common mode voltage in LVDS driver
Differential input “H” Threshold voltage	V _{TH}	–	–	+100	mV	
Differential input voltage	V _i	0	–	2.4	V	R _T = 100 Ω
Common mode voltage	V _{CM}	1.125	1.25	1.375	V	R _T = 100 Ω
Terminating resistor	R _T	–	100	–	Ω	–
Supply current	I _{CC}	–	270 Note	600	mA	V _{CC} = 5.0 V

- Notes**
1. Checker flag pattern (in EIAJ ED-2522)
 2. Theoretical maximum current pattern

(2) Backlight

T_a = 25°C

Parameters	Symbols	Min.	Typ.	Max.	Unit	Remarks
Lamp current	I _L	3.0	6.1	6.5	mArms	–
Lamp voltage	V _L	–	650	–	Vrms	I _L = 6.1 mArms
Lamp turn on voltage Note 1	V _s	1050	–	–	Vrms	T _a = 25°C
		1550	–	–	Vrms	T _a = 0°C
Oscillator frequency	F _t	53	–	67	KHz	Note 2

- Notes**
1. When V_s is less than Min. value, lamps might be not turned on.
 2. Recommended value of “F_t”.
 - F_t is within the specification.
 - $F_t = \frac{1}{4} th \times (2n-1)$ th : Hsync period
n : a natural number (1, 2, 3 ...)

If F_t is out of the recommended value, interference between F_t frequency and Hsync frequency may cause beat on the display.

SUPPLY VOLTAGE SEQUENCE

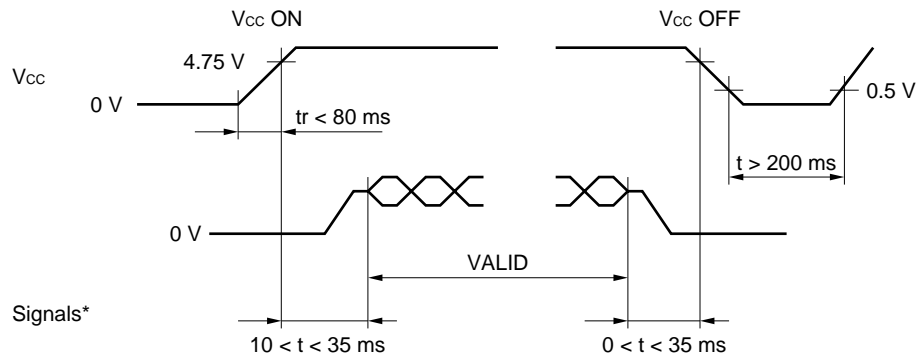

* The termination of the signal line is connected to resistance 100 Ω .

- Notes**
1. Logic signals (synchronous signals and control signals) must be "0" voltage (V), when V_{cc} is not applied. If input voltage to signal lines is higher than 0.3 V, the internal circuit will be damaged.
 2. The supply voltage for input signals should be the same as V_{cc} .
 3. Turn on the backlight within the LCD operation period. When the backlight turns on before LCD operation or the LCD operation turns off before the backlight turns off, the display may momentarily become white.
 4. When the power is off, keep whole signals low level or high impedance.

www.DataSheet4U.com

INTERFACE AND CONNECTOR PIN ASSIGNMENT

(1) Interface connector for signal and power

CN1

Part No. : FI-SE20P-HF

Adaptable socket: FI-SE20M

Supplier : Japan Aviation Electronics Industry Limited (JAE)

Pin No.	Symbol	Signal type	Function
1	GND	Ground	Note 1
2	GND		
3	NC	Non-connection	-
4	NC		
5	GND	Ground	Note
6	CK+	Pixel clock	CLK for pixel data $f = 65$ MHz (typ.) (LVDS level)
7	CK-		
8	GND	Ground	Note
9	D2+	Pixel data	LVDS differential data input
10	D2-		
11	GND	Ground	Note
12	D1+	Pixel data	LVDS differential data input
13	D1-		
14	GND	Ground	Note
15	D0+	Pixel data	LVDS differential data input
16	D0-		
17	GND	Ground	Note
18	GND		
19	V _{cc}	+5.0 V power supply	Supply +5.0 V $\pm 5\%$
20	V _{cc}		

Note GND is signal ground for logic and LCD driving. GND is connected to FG (frame ground) inside the module.

Remark Connect all pins (except 3, 4) to avoid noise issue.
Use 100 Ω twist pair wires for the cable.

CN1: Figure from socket view

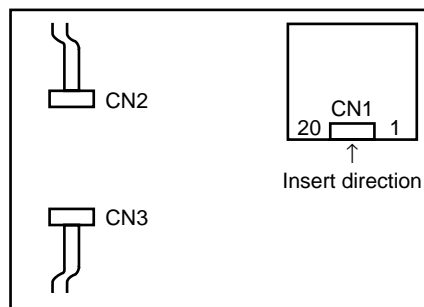
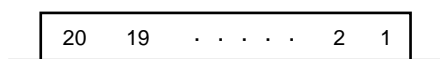

(2) Connector for backlight unit

CN2, 3

Part No. : BHR-03VS-1

Adaptable socket: SM02 (8.0)B-BHS-TB

Supplier : J.S.T. TRADING COMPANY, LTD.

Pin No.	Symbol	Function
1	V _L	Low voltage terminal (The cable color is gray.)
2	NC	Non-connection
3	V _H	High voltage terminal (The cable color is white.)

Note V_H and V_L must be connected correctly. If you make a mistake to connect, you will get hurt and the module will break.

METHOD OF CONNECTIONS FOR THC63LVDF63A

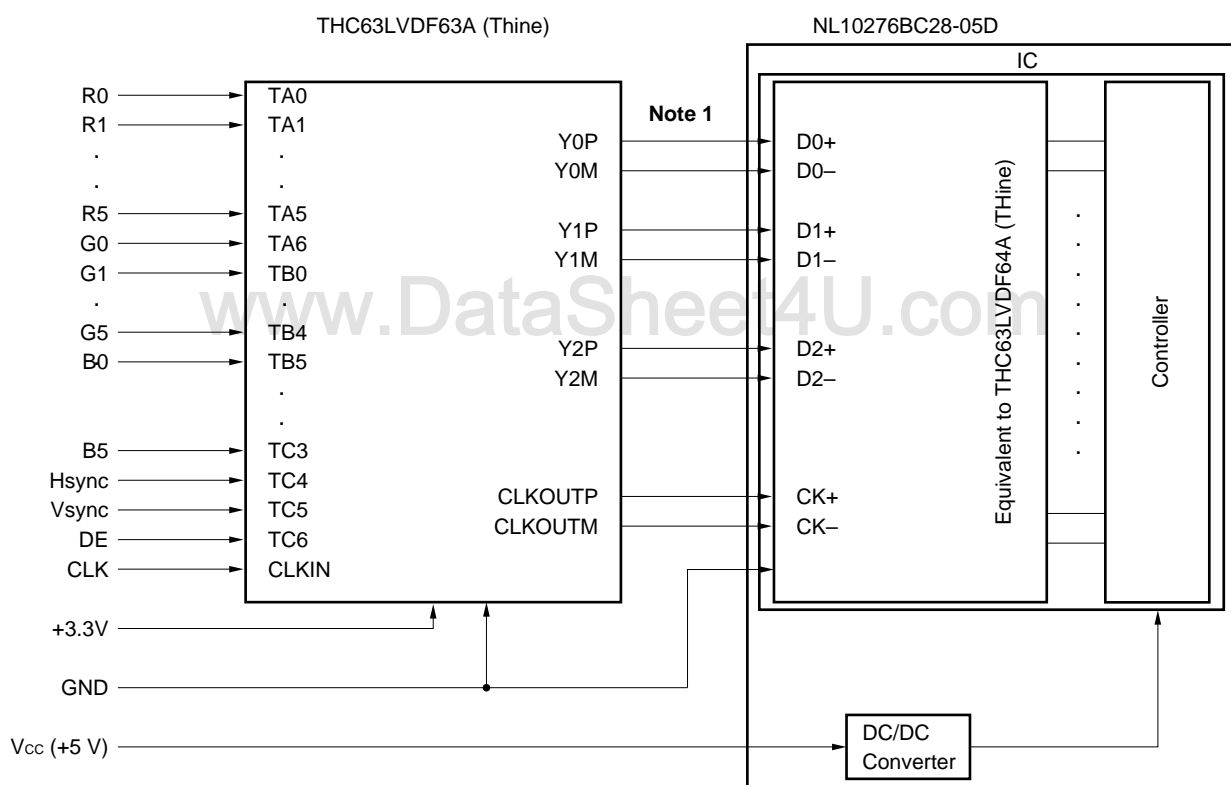

- Notes**
1. 100 Ω twist pair.
 2. These signals should be kept in the specified range of **INPUT SIGNAL TIMINGS**.
 3. V_{cci} = 3.3 V (LCD internal voltage)

DISPLAY COLORS vs. INPUT DATA SIGNALS

Display colors		Data signal (0: Low level, 1: High level)																	
		R5	R4	R3	R2	R1	R0	G5	G4	G3	G2	G1	G0	B5	B4	B3	B2	B1	B0
Basic colors	Black	0	0	0	0	0	0	0	0	0	0	0	0	0	0	0	0	0	0
	Blue	0	0	0	0	0	0	0	0	0	0	0	0	1	1	1	1	1	1
	Red	1	1	1	1	1	1	0	0	0	0	0	0	0	0	0	0	0	0
	Magenta	1	1	1	1	1	1	0	0	0	0	0	0	1	1	1	1	1	1
	Green	0	0	0	0	0	0	1	1	1	1	1	1	0	0	0	0	0	0
	Cyan	0	0	0	0	0	0	1	1	1	1	1	1	1	1	1	1	1	1
	Yellow	1	1	1	1	1	1	1	1	1	1	1	1	0	0	0	0	0	0
	White	1	1	1	1	1	1	1	1	1	1	1	1	1	1	1	1	1	1
Red grayscale	Black	0	0	0	0	0	0	0	0	0	0	0	0	0	0	0	0	0	0
		0	0	0	0	0	1	0	0	0	0	0	0	0	0	0	0	0	0
	dark	0	0	0	0	1	0	0	0	0	0	0	0	0	0	0	0	0	0
	↑				↓														
	↓				↑														
	bright	1	1	1	1	0	1	0	0	0	0	0	0	0	0	0	0	0	0
		1	1	1	1	1	0	0	0	0	0	0	0	0	0	0	0	0	0
	Red	1	1	1	1	1	1	0	0	0	0	0	0	0	0	0	0	0	0
Green grayscale	Black	0	0	0	0	0	0	0	0	0	0	0	0	0	0	0	0	0	0
		0	0	0	0	0	0	0	0	0	0	1	0	0	0	0	0	0	0
	dark	0	0	0	0	0	0	0	0	0	1	0	0	0	0	0	0	0	0
	↑				↓														
	↓				↑														
	bright	0	0	0	0	0	0	1	1	1	1	0	1	0	0	0	0	0	0
		0	0	0	0	0	0	1	1	1	1	1	0	0	0	0	0	0	0
	Green	0	0	0	0	0	0	1	1	1	1	1	1	0	0	0	0	0	0
Blue grayscale	Black	0	0	0	0	0	0	0	0	0	0	0	0	0	0	0	0	0	0
		0	0	0	0	0	0	0	0	0	0	0	0	0	0	0	0	0	1
	dark	0	0	0	0	0	0	0	0	0	0	0	0	0	0	0	0	1	0
	↑				↓														
	↓				↑														
	bright	0	0	0	0	0	0	0	0	0	0	0	0	1	1	1	1	0	1
		0	0	0	0	0	0	0	0	0	0	0	0	1	1	1	1	1	0
	Blue	0	0	0	0	0	0	0	0	0	0	0	0	1	1	1	1	1	1

Note Colors are developed in combination with 6-bit signals (64 steps in grayscale) of each primary red, green, and blue color.

This process can result in up to 262,144 ($64 \times 64 \times 64$) colors.

INPUT SIGNAL TIMINGS

(1) Input signal specifications for LCD controller

Parameter		Symbol	min.	typ.	max.	Unit	Remarks	
CLK	Frequency	1/tc	60.0	65.0	68.0	MHz	-	
			-	15.385	-	ns		
	Rise, fall	tcrf	Note			ns	-	
	Duty	tch/tc				-	-	
Hsync	Period	th	16.0	20.676	-	μ s	48.363 kHz (typ.)	
			110	1344	1780	CLK		
	Display period	thd	-	1024	-	CLK	-	
	Front-porch	thf	0	-	-	CLK	-	
	Pulse width	thp*	12	-	-	CLK	-	
	Back-Porch	thb	2	-	-	CLK	-	
	*thp + thb			86	-	-	CLK	-
	Hsync-CLK timing	ths	Note			ns	-	
	CLK-Hsync timing	thh				ns	-	
	DE-CLK timing	tcs				ns	-	
	CLK-DE timing	tch				ns	-	
	Rise, fall	thrf, terf				ns	-	
	Vsync	Period	tv	-	16.666	-	ms	60.004 Hz (typ.)
-				806	-	H		
Display period		tvd	768			H	-	
Front-porch		tvf	1	-	-	H	-	
Pulse width		tvp*	1	3	36	H	-	
Back-porch		tvb*	1	-	36	H	-	
*tvp + tvb			3	-	38	H	-	
Vsync-Hsync timing		tvs	10	-	-	ns	Note	
Hsync-Vsync timing		tvh	1	-	-	CLK	Note	
Rise, fall	tvrf	-	-	10	ns	Note		
DATA	DATA-CLK (set up)	tds	1	-	-	ns	Note	
	CLK-DATA (Hold)	tdh	2	-	-	ns	Note	
DE	DE-CLK timing	tes	1	-	-	ns	-	
	CLK-DE timing	teh	2	-	-	ns		
	Rise, fall	terf	-	-	10	ns		

Note These values are in the timing regulation of THC63LVDF64A (THine).

The product equivalent to THC63LVDF63A (THine) is recommended to the input of LVDS transmitter.

The Timing regulation prescribes in the input of the LVDS transmitter.

(2) Definition of input signal timing for LCD controller

<Vertical>

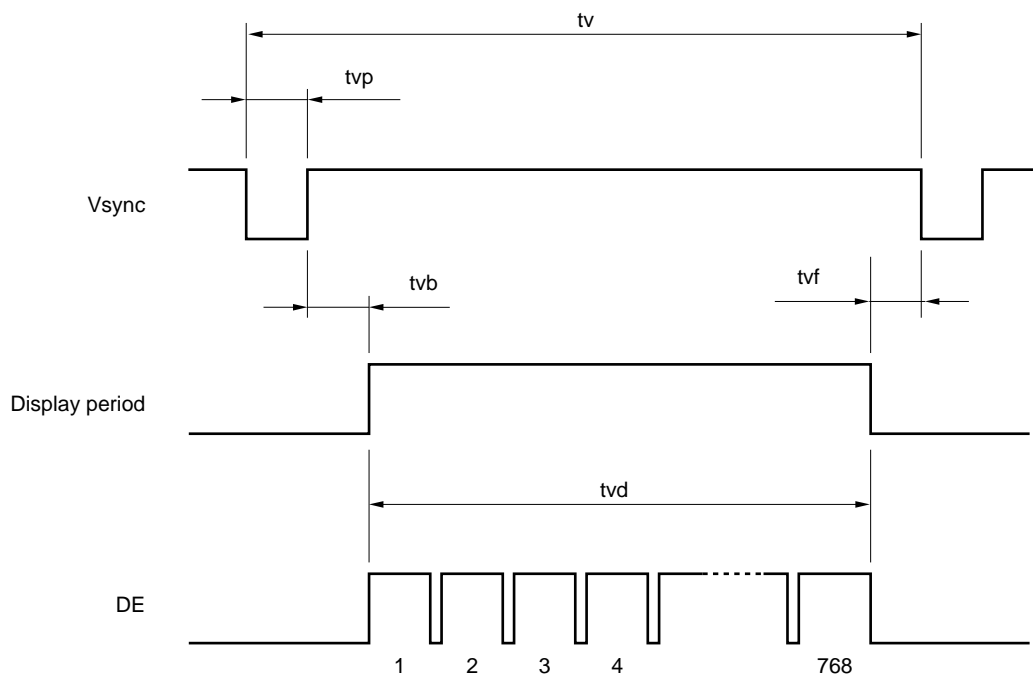

<Horizontal>

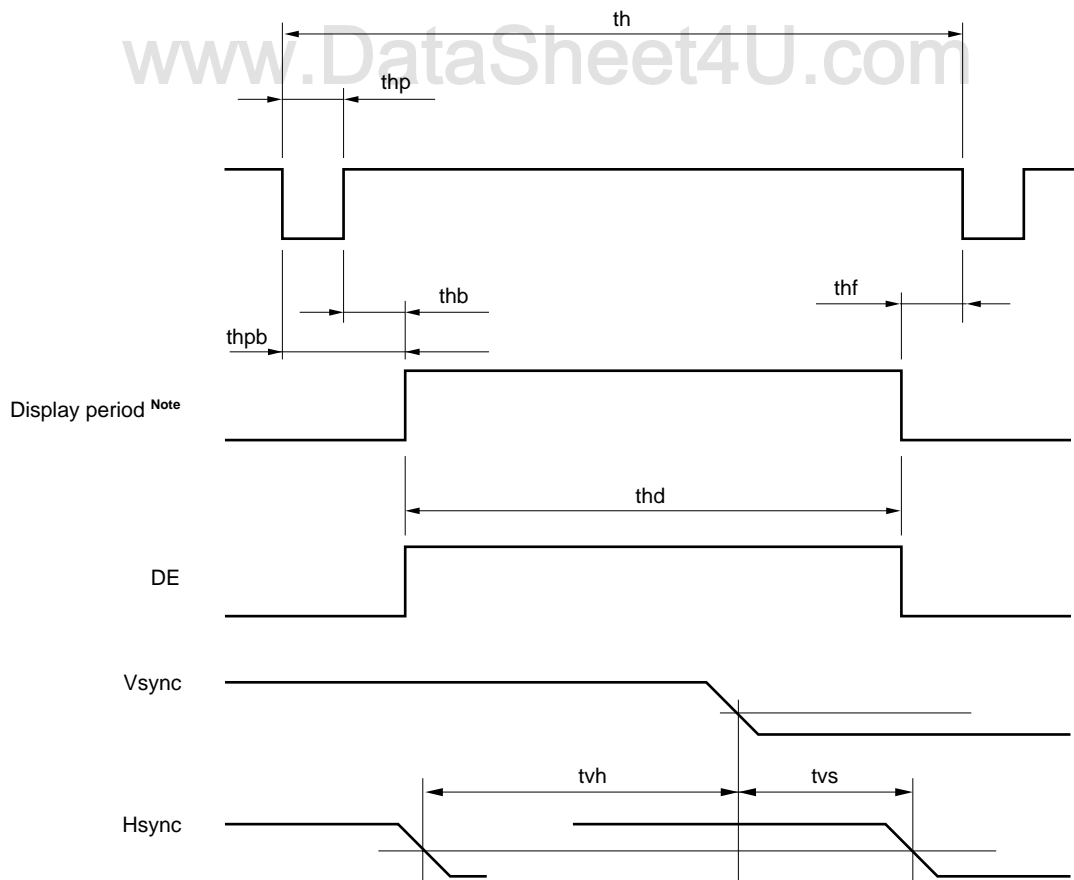

- Notes**
1. "Display period" do not exist as signals.
 2. These values are in the output of THC63LVDF64A.
(Refer to **METHOD OF CONNECTION FOR THC63LVDF63A**)

(3) Input signal timing chart

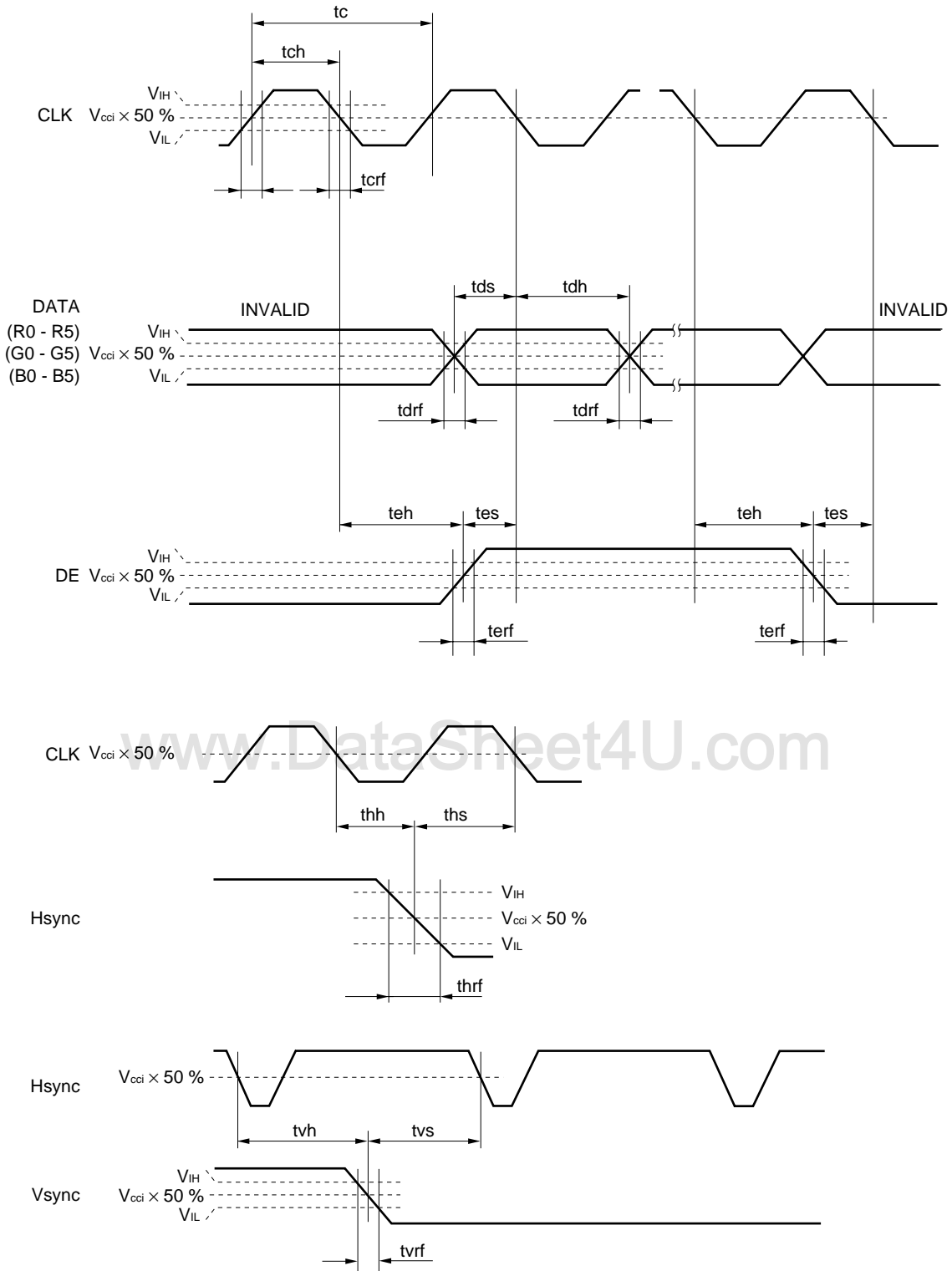

Note V_{IH} , V_{IL} : Refer to LVDS transmitter specifications.

(4) DE

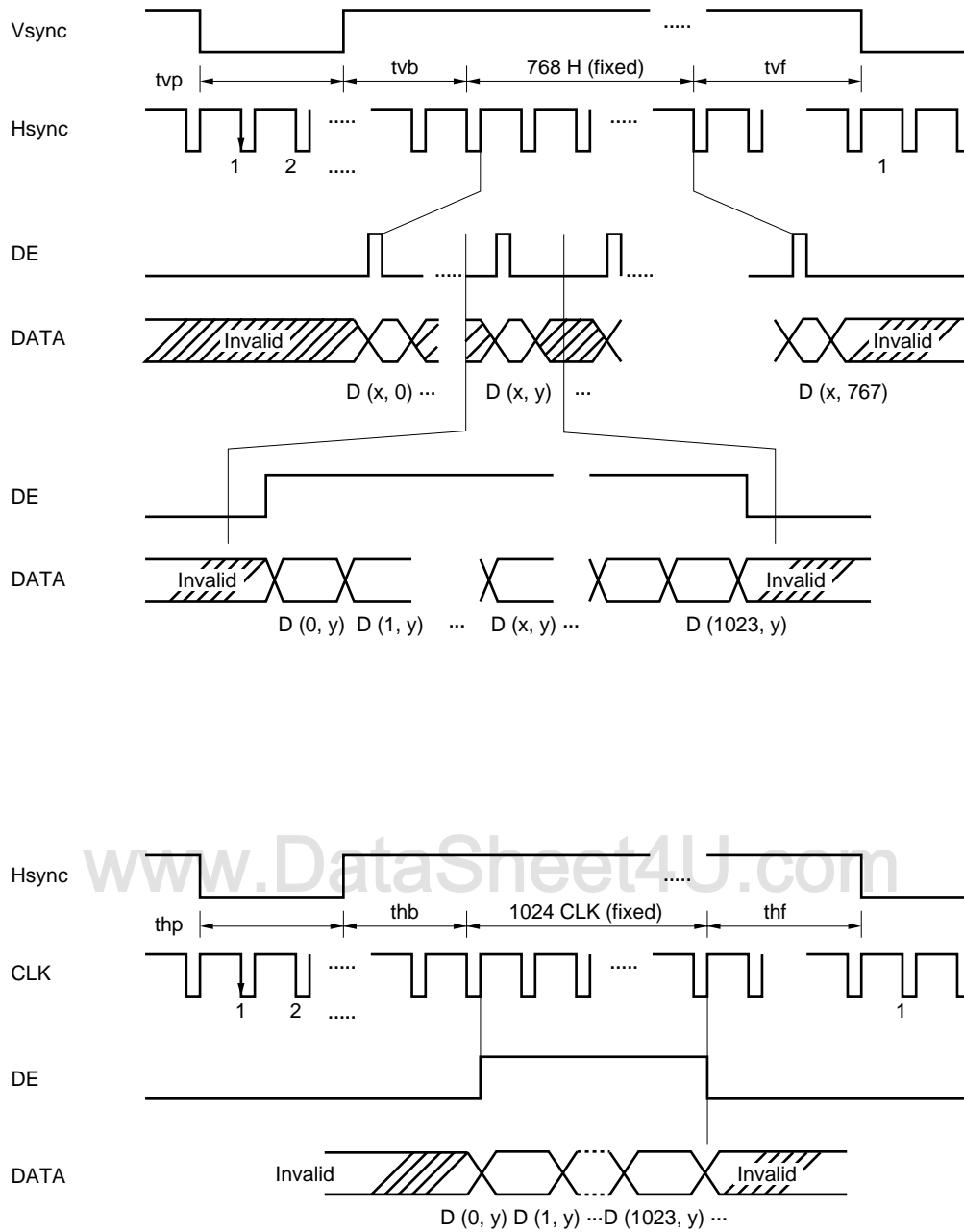

Note These values are in the output of THC63LVDF64A.
(Refer to **METHOD OF CONNECTION FOR THC63LVDF63A**).

(5) Display position of input data

D (0, 0)	D (1, 0)	---	D (X, 0)	---	D (1022, 0)	D (1023, 0)
D (0, 1)	D (1, 1)	---	D (X, 1)	---	D (1022, 1)	D (1023, 1)
		+-		+-		
D (0, Y)	D (1, Y)	---	D (X, Y)	---	D (1022, Y)	D (1023, Y)
		+-		+-		
D (0, 766)	D (1, 766)	---	D (X, 766)	---	D (1022, 766)	D (1023, 766)
D (0, 767)	D (1, 767)	---	D (X, 767)	---	D (1022, 767)	D (1023, 767)

www.DataSheet4U.com

FOR LVDS RECEIVER

(1) Input signal specifications

Parameter	Symbol	Min	Typ.	Max.	Unit	Remarks
CLK Frequency	TRCP	14.71	T	16.66	ns	T = 15.38 ns
Bit0 position	TRIP1	-0.5	0	+0.5	ns	
Bit1 position	TRIP0	T/7-0.5	T/7	T/7+0.5	ns	
Bit2 position	TRIP6	2T/7-0.5	2T/7	2T/7+0.5	ns	
Bit3 position	TRIP5	3T/7-0.5	3T/7	3T/7+0.5	ns	
Bit4 position	TRIP4	4T/7-0.5	4T/7	4T/7+0.5	ns	
Bit5 position	TRIP3	5T/7-0.5	5T/7	5T/7+0.5	ns	
Bit6 position	TRIP2	6T/7-0.5	6T/7	6T/7+0.5	ns	

(2) Input signal timing chart

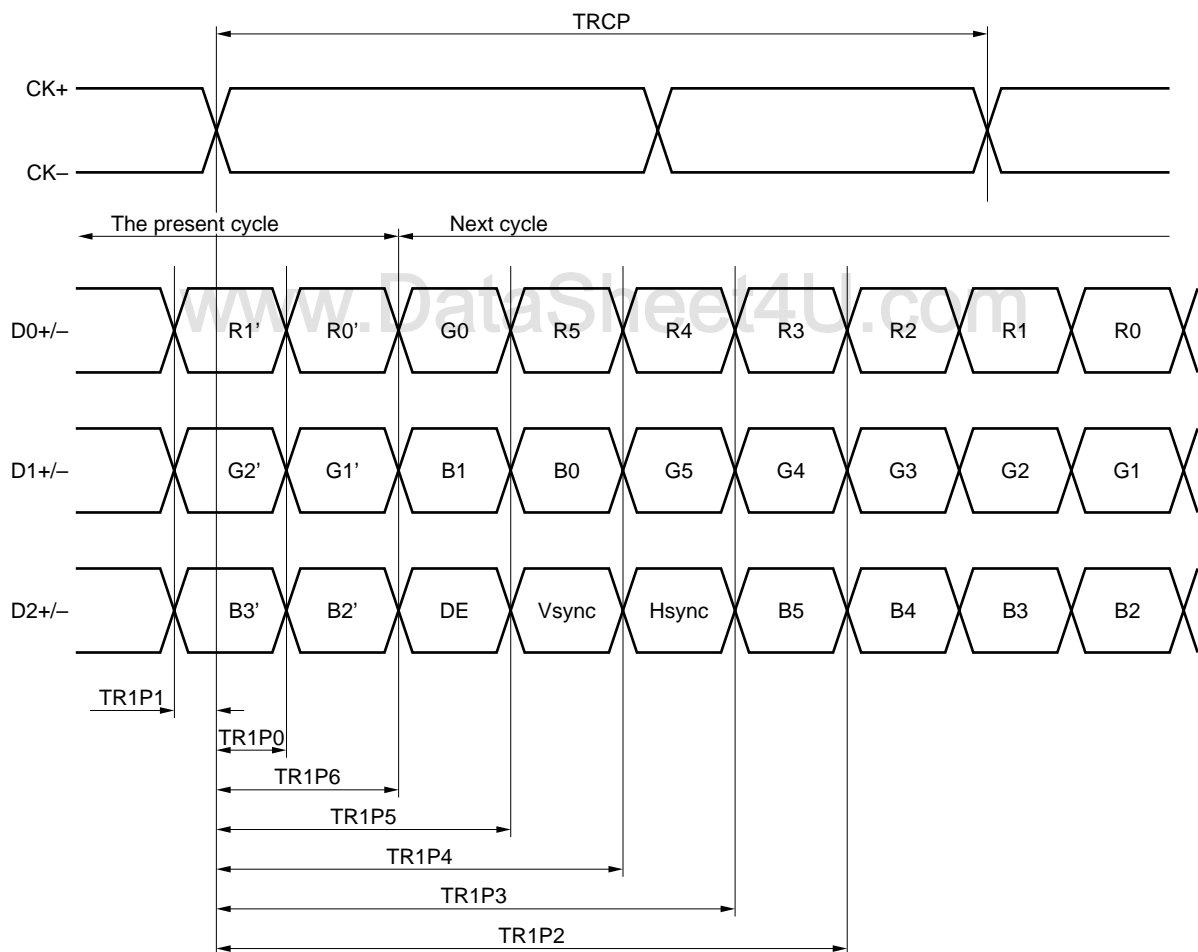

OPTICAL CHARACTERISTICS

(T_a = 25°C, Note 1, 2)

Parameter	Symbol	Condition	MIN.	TYP.	MAX.	Unit	Remark
Contrast ratio	CR	at center	80	150	–	–	Note 3
Luminance	Lumax	"White", at center	150	200	–	cd/m ²	–
Luminance uniformity	–	Maximum/Minimum	–	–	1.30	–	Note 4

Reference data

(T_a = 25°C, V_{CC} = 5 V, V_{DD}B = 12 V)

Parameter	Symbol	Condition	MIN.	TYP.	MAX.	Unit	Remark	
Contrast ratio	CR	Best contrast angle, $\theta X = \pm 0^\circ$, $\theta Y = -5^\circ$, at center	–	300	–	–	Note 3	
Color gamut	C	To NTSC, at center	35	40	–	%	Note 2	
Viewing angle range	Horizontal	$\theta X+$	CR > 10, $\theta Y = \pm 0^\circ$	40	50	–	deg.	Note 5
		$\theta X-$	CR > 10, $\theta Y = \pm 0^\circ$	40	50	–	deg.	
	Vertical	$\theta Y+$	CR > 10, $\theta X = \pm 0^\circ$	15	20	–	deg.	
		$\theta Y-$	CR > 10, $\theta X = \pm 0^\circ$	25	35	–	deg.	
Response time	ton	White to black	–	11	25	ms	Note 6	
	toff	Black to white	–	40	80			

Notes 1. The luminance is measured after 20 minutes from the module works, with all pixels in white. Typical value is measured after luminance saturation.

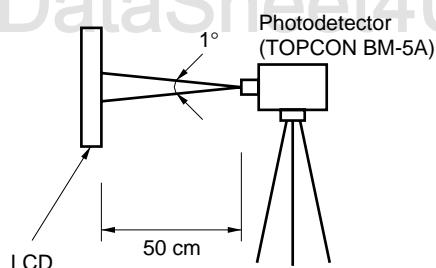

- Viewing angle is $\theta x = \pm 0^\circ$, $\theta y = \pm 0^\circ$
- The contrast ratio is calculated by using the following formula.

$$\text{Contrast ratio (CR)} = \frac{\text{Luminance with all pixels in white}}{\text{Luminance with all pixels in black}}$$

The Luminance is measured in darkroom.

4. Luminance uniformity is calculated using following formula.

$$\text{Luminance uniformity} = \frac{\text{Maximum Luminance}}{\text{Minimum Luminance}}$$

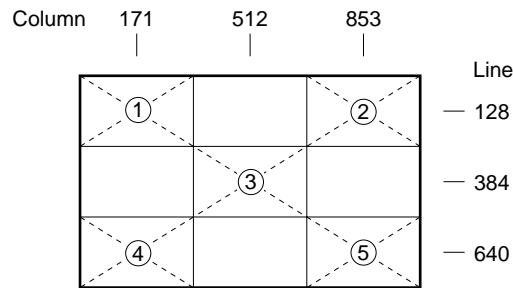

5. Definitions of viewing angle are as follows.

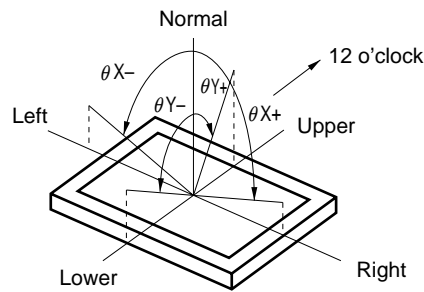

6. Definition of response time is as follows.

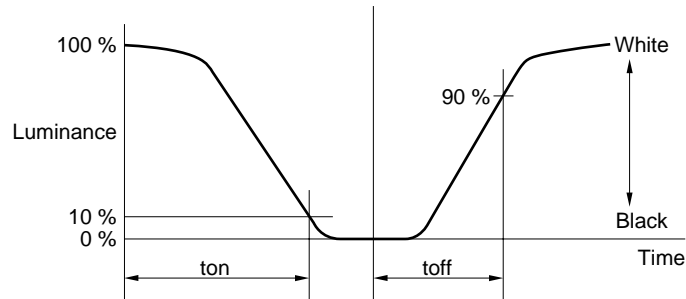

RELIABILITY TEST

Test item	Test condition
High temperature/humidity operation Note 1	50 ± 2°C, 85% relative humidity 240 hours Display data is black.
Heat cycle (operation) Note 1	<1> 0°C ± 3°C ... 1 hour 55°C ± 3°C ... 1 hour <2> 50 cycles, 4 hours/cycle <3> Display data is black.
Thermal shock (non-operation) Note 1	<1> -20°C ± 3°C ... 30 minutes 60°C ± 3°C ... 30 minutes <2> 100 cycles <3> Temperature transition time within 5 minutes
Vibration (non-operation) Notes 1, 2	<1> 5 - 100 Hz, 19.6 m/s ² (2G) 1 minute/cycle X, Y, Z direction <2> 50 times each direction
Mechanical shock (non-operation) Notes 1, 2	<1> 294 m/s ² (30 G), 11 ms X, Y, Z direction <2> 3 times each direction
ESD (operation) Notes 1, 3	150 pF, 150 Ω, ±10 kV 9 places on a panel 10 times each place at one-second intervals
Dust (operation) Note 1	15 kinds of dust (JIS Z 8901) Hourly 15 seconds stir, 8 times repeat

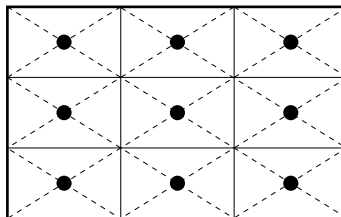

- Notes**
1. Display function is checked by the same condition as LCD module out-going inspection.
 2. Physical damage.
 3. Discharge points "●" are shown in the figure.



GENERAL CAUTIONS

Next figures and sentences are very important. Please understand these contents as follows.

	CAUTION This mark indicates that you will get hurt and/or the module will have damages when you make a mistake to operate.
---	--

	This mark indicates that you will get an electric shock when you make a mistake to operate.
	This mark indicates that you will get hurt when you make a mistake to operate



	Do not touch an inverter, on which is stuck a caution label, while the LCD module is under the operation, because of dangerous high voltage.
---	--

(1) Caution when taking out the module

- a) Pick the pouch only, when taking out the module from a carrier box.

(2) Cautions for handling the module

- a) As the electrostatic discharges may break the LCD module, handle the LCD module with care against electrostatic discharges.
- b)  As the LCD panel and backlight element are made from fragile glass material, impulse and pressure to the LCD module should be avoided.
- c) As the surface of polarizer is very soft and easily scratched, use a soft dry cloth without chemicals for cleaning.
- d) Do not pull the interface connectors in or out while the LCD module is operating.
- e) Put the module display side down on a flat horizontal plane.
- f) Handle connectors and cables with care.
- g) When the module is operating, do not lose CLK, Hsync or Vsync signal. If any one of these signals is lost, the LCD panel would be damaged.
- h) The torque for mounting screw should never exceed 0.392 N·m (4 kgf·cm).
- i) Don't push or rub the surface of LCD modules.
If you do it, the scratches or the rubbing marks may be left on the surface of the modules.

(3) Cautions for the atmosphere

- a) Dew drop atmosphere should be avoided.
- b) Do not store and/or operate the LCD module in a high temperature and/or high humidity atmosphere. Storage in an anti-static pouch and under the room temperature atmosphere is recommended.
- c) This module uses cold cathod fluorescent lamp. Therefore, the life time of lamp becomes short if the module is operated under the low temperature environment.
- d) Do not operate the LCD module in a high magnetic field.

(4) Caution for the module characteristics

- a) Do not apply fixed pattern data signal for a long time to the module. It may cause image sticking. Please use screen savers if the display pattern is fixed for a long time.
- b) This module has the retardation film which may cause the variation of the color hue in the different viewing angles. The ununiformity may appear on the screen under the high temperature operation.
- c) The light vertical stripe may be observed depending on the display pattern. This is neither defects nor malfunctions.
- d) The noise from the inverter circuit may be observed in the luminance control mode. This is neither defects nor malfunctions.

(5) Other cautions

- a) Do not disassemble and/or reassemble LCD module.
- b) Do not readjust variable resistors or switches in the module.
- c) When returning the module for repair etc., please pack the module properly to avoid any damages. We recommend using the original shipping packages.

Liquid Crystal Display has the following specific characteristics. There are neither defects nor malfunctions.

The optical characteristics of this module may be affected by the ambient temperature. This module has cold cathode tube for backlight. Optical characteristics, like luminance or uniformity, will be changed by the progress in time.

Uneven brightness and/or small spots may be observed depending on different display patterns.

www.DataSheet4U.com

OUTLINE DRAWING: Front View (Unit: mm)

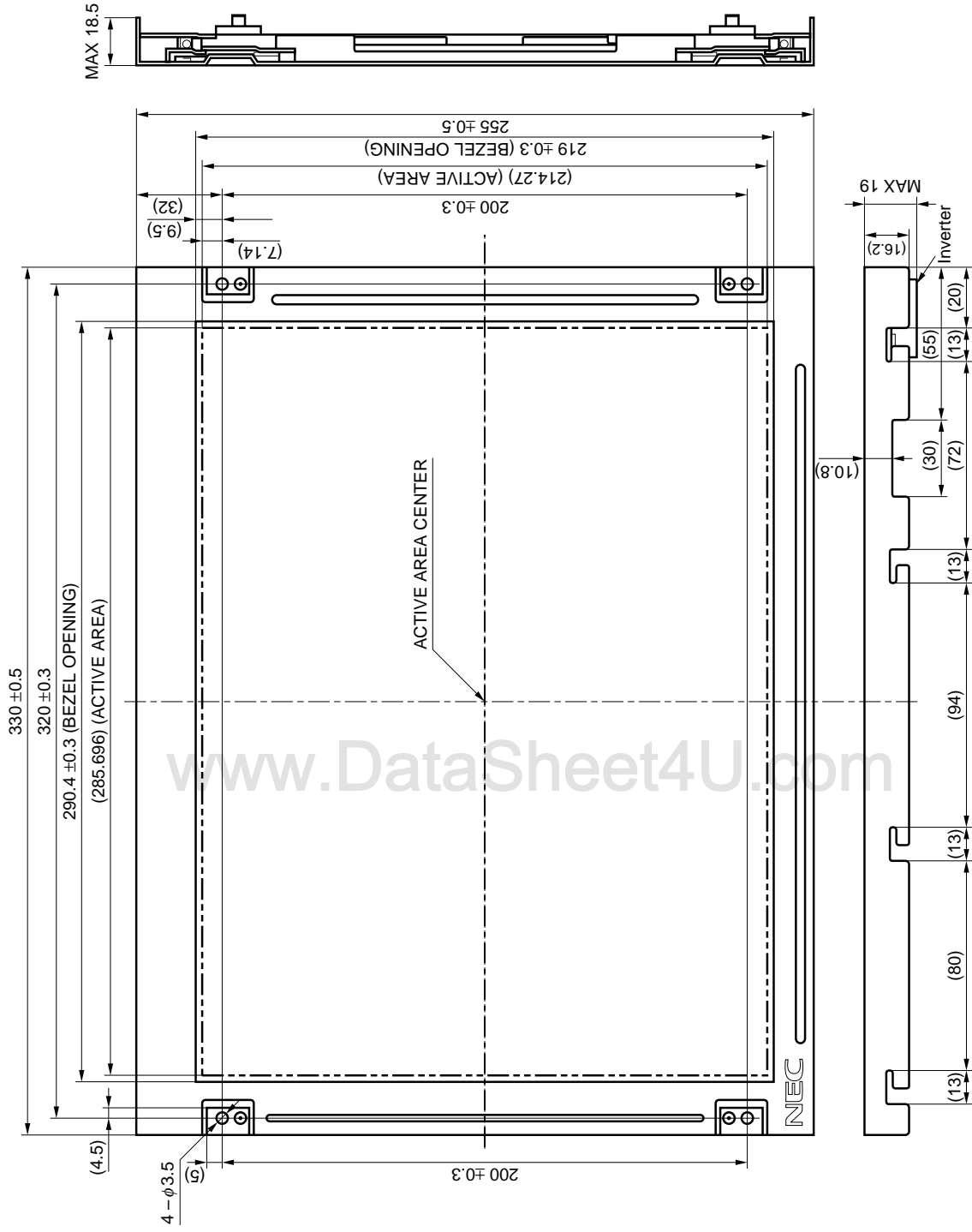

- Notes 1. Not shown tolerance of the dimensions are ±0.5 mm.
- 2. The torque to mounting screw should never exceed 0.392 N·m (4 Kgf·cm).

OUTLINE DRAWING: Rear View (Unit: mm)

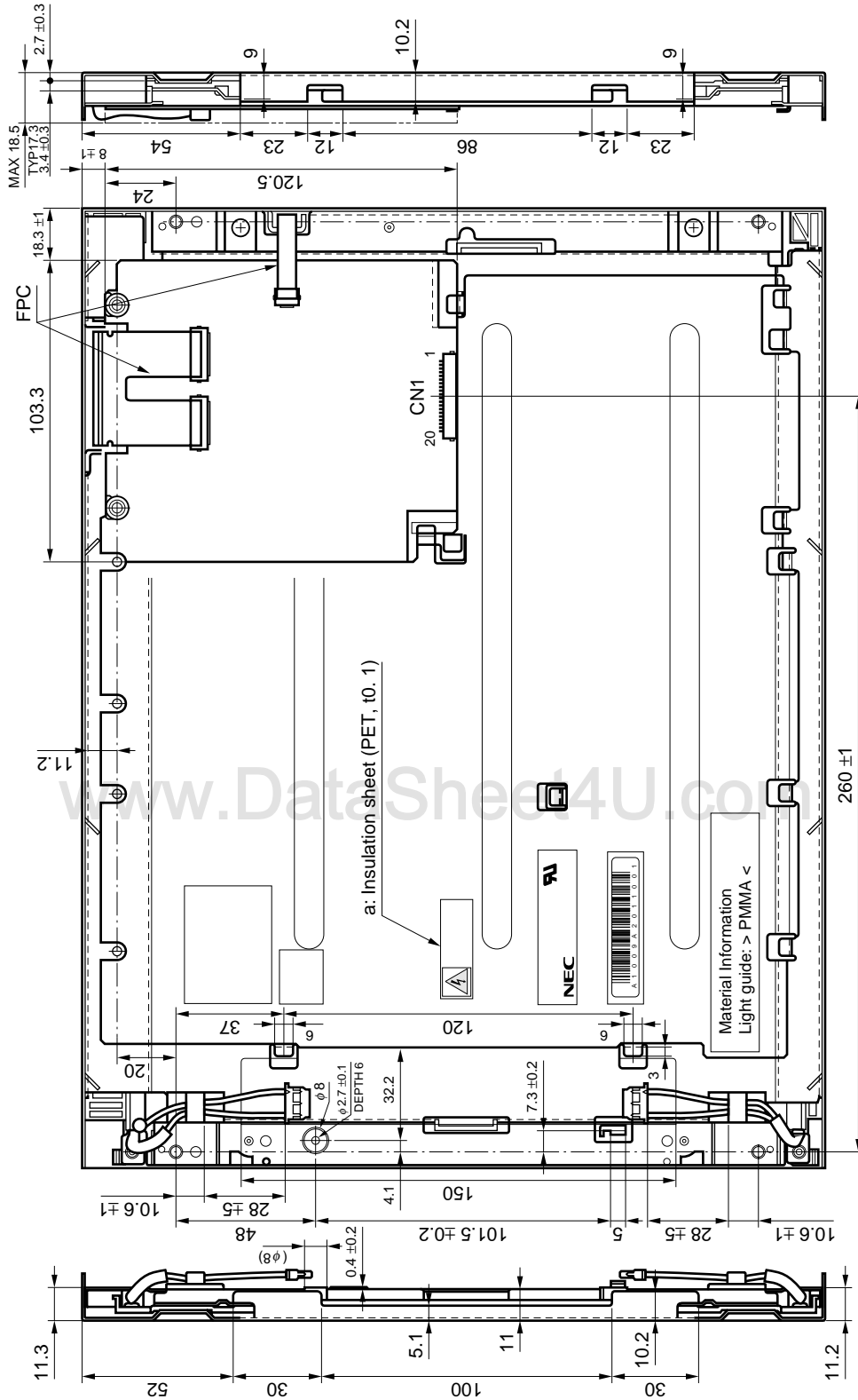

MEMO

www.DataSheet4U.com

No part of this document may be copied or reproduced in any form or by any means without the prior written consent of NEC Corporation. NEC Corporation assumes no responsibility for any errors which may appear in this document.

NEC Corporation does not assume any liability for infringement of patents. Copyrights or other intellectual property rights of third parties by or arising from use of a device described herein or any other liability arising from use of such device. No license, either express, implied or otherwise, is granted under any patents, copyrights or other intellectual property rights of NEC Corporation or others.

While NEC Corporation has been making continuous effort to enhance the reliability of its Electronic Components, the possibility of defects cannot be eliminated entirely. To minimize risks of damage or injury to persons or property arising from a defect in an NEC Electronic Components, customers must incorporate sufficient safety measures in its design, such as redundancy, fire-containment, and anti-failure features.

NEC devices are classified into the following three quality grades:

“Standard”, “Special”, and “Specific”. The Specific quality grade applies only to devices developed based on a customer designated “quality assurance program” for a specific application. The recommended applications of a device depend on its quality grade, as indicated below. Customers must check the quality grade of each device before using it in a particular application.

Standard: Computers, office equipment, communications equipment, test and measurement equipment, audio and visual equipment, home electronic appliances, machine tools, personal electronic equipment and industrial robots

Special: Transportation equipment (automobiles, trains, ships, etc.), traffic control systems, anti-disaster systems, anti-crime systems, safety equipment and medical equipment (not specifically designed for life support)

Specific: Aircrafts, aerospace equipment, submersible repeaters, nuclear reactor control systems, life support systems or medical equipment for life support, etc.

The quality grade of NEC devices is “Standard” unless otherwise specified in NEC’s Data Sheets or Data Books.

If customers intend to use NEC devices for applications other than those specified for Standard quality grade, they should contact an NEC sales representative in advance.

Anti-radioactive design is not implemented in this product.