

TABLE OF CONTENTS

Specifications.....	3	Write Modes.....	17
Electrical Characteristics.....	3	Read Modes.....	17
Timing Characteristics.....	5	Store/Restore Modes.....	17
Absolute Maximum Ratings.....	6	Tolerance Readback Modes.....	18
ESD Caution.....	6	ESD Protection of Digital Pins and Resistor Terminals.....	19
Pin Configuration and Function Descriptions.....	7	Power-Up Sequence.....	19
Typical Performance Characteristics.....	8	Layout and Power Supply Bypassing.....	19
Test Circuits.....	13	Multiple Devices on One Bus.....	19
Theory of Operation.....	14	Evaluation Board.....	19
Programming the Variable Resistor.....	14	Display Applications.....	20
Programming the Potentiometer Divider.....	14	Circuitry.....	20
I ² C Interface.....	15	Outline Dimensions.....	21
I ² C Byte Formats.....	16	Ordering Guide.....	21
Generic Interface.....	16		

REVISION HISTORY**3/05—Revision 0: Initial Version**

SPECIFICATIONS

ELECTRICAL CHARACTERISTICS

$V_{DD} = V_{LOGIC} = 5\text{ V} \pm 10\%$, or $3\text{ V} \pm 10\%$; $V_A = V_{DD}$; $V_B = 0\text{ V}$; $-40^\circ\text{C} < T_A < +85^\circ\text{C}$, unless otherwise noted.

Table 1.

Parameter	Symbol	Conditions	Min	Typ ¹	Max	Unit
DC CHARACTERISTICS: RHEOSTAT MODE						
Resistor Differential Nonlinearity 1 k Ω 10 k Ω /50 k Ω /100 k Ω	R-DNL	R_{WB} , $V_A = \text{no connect}$	-1.5 -0.25	± 0.3 ± 0.1	+1.5 +0.25	LSB
Resistor Integral Nonlinearity 1 k Ω 10 k Ω /100 k Ω 50 k Ω	R-INL	R_{WB} , $V_A = \text{no connect}$	-5 -0.5 -0.25	± 0.5 ± 0.1 ± 0.1	+5 +0.5 +0.25	LSB
Nominal Resistor Tolerance 1 k Ω 10 k Ω /50 k Ω /100 k Ω	R_{AB} ΔR_{AB}	$T_A = 25^\circ\text{C}$, $V_{DD} = 5.5\text{ V}$	0.9 -30		1.5 +30	k Ω %
Resistance Temperature Coefficient	$(\Delta R_{AB} \times 10^6)/(R_{AB} \times \Delta T)$	Code = 0x00/0x20		200/15		ppm/ $^\circ\text{C}$
Total Wiper Resistance	R_{WB}	Code = 0x00		75	350	Ω
DC CHARACTERISTICS: POTENTIOMETER DIVIDER MODE						
Differential Nonlinearity 1 k Ω 10 k Ω /50 k Ω /100 k Ω	DNL		-1 -0.25	± 0.3 ± 0.1	+1 +0.25	LSB
Integral Nonlinearity 1 k Ω 10 k Ω /50 k Ω /100 k Ω	INL		-1 -0.25	± 0.3 ± 0.1	+1 +0.25	LSB
Full-Scale Error 1 k Ω 10 k Ω 50 k Ω /100 k Ω	V_{WFSE}	Code = 0x3F	-6 -1 -1	-3 -0.3 -0.1	0 0 0	LSB
Zero-Scale Error 1 k Ω 10 k Ω 50 k Ω /100 k Ω	V_{WZSE}	Code = 0x00	0 0 0	3 0.3 0.1	5 1 0.5	LSB
Voltage Divider Temperature Coefficient	$(\Delta V_W \times 10^6)/(V_W \times \Delta T)$	Code = 0x00/0x20		120/15		ppm/ $^\circ\text{C}$
RESISTOR TERMINALS						
Voltage Range	$V_{A,B,W}$		GND		V_{DD}	V
Capacitance A, B	$C_{A,B}$	$f = 1\text{ MHz}$, measured to GND, code = 0x20		45		pF
Capacitance W	C_W	$f = 1\text{ MHz}$, measured to GND, code = 0x20		60		pF
Common-Mode Leakage	I_{CM}	$V_A = V_B = V_{DD}/2$		10		nA
DIGITAL INPUTS AND OUTPUTS						
Input Logic High	V_{IH}		$0.7 \times V_L$		$V_L + 0.5$	V
Input Logic Low	V_{IL}		-0.5		$0.3 \times V_L$	V
Leakage Current	I_{IL}					μA
SDA, AD0, AD1		$V_{IN} = 0\text{ V}$ or 5 V		0.01	± 1	
SCL – Logic High		$V_{IN} = 0\text{ V}$	-2.5	-1.4	+1	
SCL – Logic Low		$V_{IN} = 5\text{ V}$		0.01	± 1	
Input Capacitance	C_{IL}			5		pF

AD5258

Parameter	Symbol	Conditions	Min	Typ ¹	Max	Unit
POWER SUPPLIES						
Power Supply Range	V _{DD}		2.7		5.5	V
Positive Supply Current	I _{DD}			0.5	2	μA
Logic Supply	V _{LOGIC}		2.7		5.5	V
Logic Supply Current	I _{LOGIC}	V _{IH} = 5 V or V _{IL} = 0 V		3.5	6	μA
Programming Mode Current (EEPROM)	I _{LOGIC(PROG)}	V _{IH} = 5 V or V _{IL} = 0 V		35		mA
Power Dissipation	P _{DISS}	V _{IH} = 5 V or V _{IL} = 0 V, V _{DD} = 5 V		20	40	μW
Power Supply Rejection Ratio	PSRR	V _{DD} = +5 V ± 10%, Code = 0x20		±0.01	±0.06	%/%
DYNAMIC CHARACTERISTICS						
Bandwidth –3 dB	BW	Code = 0x20 R _{AB} = 1 kΩ R _{AB} = 10 kΩ R _{AB} = 50 kΩ R _{AB} = 100 kΩ		18000 1000 190 100		kHz kHz kHz kHz
Total Harmonic Distortion	THD _w	R _{AB} = 10 kΩ, V _A = 1 V rms, V _B = 0, f = 1 kHz		0.1		%
V _w Settling Time	t _s	R _{AB} = 10 kΩ, V _{AB} = 5 V, ±1 LSB error band		500		ns
Resistor Noise Voltage Density	e _{N_WB}	R _{WB} = 5 kΩ, f = 1 kHz		9		nV/√Hz

¹ Typical values represent average readings at 25°C and V_{DD} = 5 V.

TIMING CHARACTERISTICS

$V_{DD} = V_{LOGIC} = 5 V \pm 10\%$, or $3 V \pm 10\%$; $V_A = V_{DD}$; $V_B = 0 V$; $-40^{\circ}C < T_A < +85^{\circ}C$, unless otherwise noted.

Table 2.

Parameter	Symbol	Conditions	Min	Typ	Max	Unit
I²C INTERFACE TIMING CHARACTERISTICS						
SCL Clock Frequency	f_{SCL}		0		400	kHz
t_{BUF} Bus Free Time between STOP and START	t_1		1.3			μs
$t_{HD,STA}$ Hold Time (Repeated START)	t_2	After this period, the first clock pulse is generated.	0.6			μs
t_{LOW} Low Period of SCL Clock	t_3		1.3			μs
t_{HIGH} High Period of SCL Clock	t_4		0.6			μs
$t_{SU,STA}$ Setup Time for Repeated START Condition	t_5		0.6			μs
$t_{HD,DAT}$ Data Hold Time	t_6		0		0.9	μs
$t_{SU,DAT}$ Data Setup Time	t_7		100			ns
t_F Fall Time of Both SDA and SCL Signals	t_8				300	ns
t_R Rise Time of Both SDA and SCL Signals	t_9				300	ns
$t_{SU,STO}$ Setup Time for STOP Condition	t_{10}		0.6			μs
EEPROM Data Storing Time	t_{EEMEM_STORE}			26		ms
EEPROM Data Restoring Time at Power On ¹	$t_{EEMEM_RESTORE1}$	V_{DD} rise time dependant. Measure without decoupling capacitors at V_{DD} and GND.		300		μs
EEPROM Data Restoring Time upon Restore Command ¹	$t_{EEMEM_RESTORE2}$	$V_{DD} = 5 V$.		300		μs
EEPROM Data Rewritable Time ²	$t_{EEMEM_REWRITE}$			540		μs
FLASH/EE MEMORY RELIABILITY						
Endurance ³			100	700		kCycles
Data Retention ⁴				100		Years

¹ During power-up, the output is momentarily preset to midscale before restoring EEPROM content.

² Delay time after power-on PRESET prior to writing new EEPROM data.

³ Endurance is qualified to 100,000 cycles per JEDEC Std. 22 method A117, and is measured at $-40^{\circ}C$, $+25^{\circ}C$, and $+85^{\circ}C$; typical endurance at $+25^{\circ}C$ is 700,000 cycles.

⁴ Retention lifetime equivalent at junction temperature (T_J) = $55^{\circ}C$ per JEDEC Std. 22, Method A117. Retention lifetime based on an activation energy of 0.6eV derates with junction temperature.

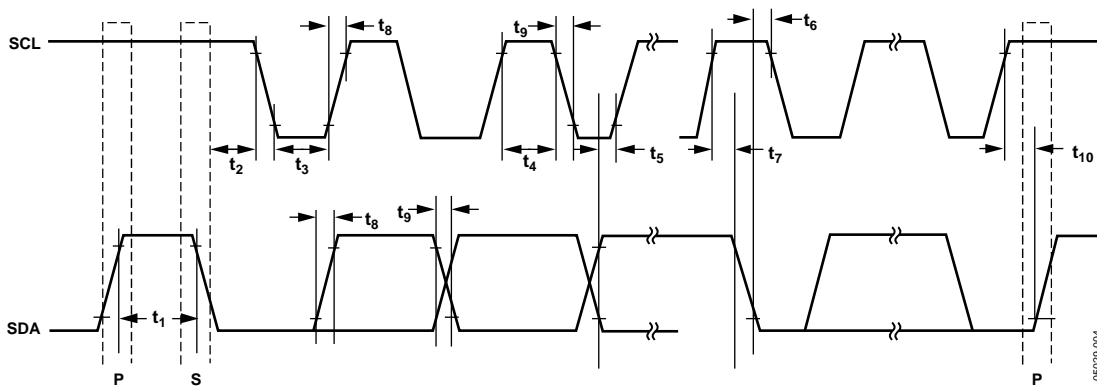

Figure 4. I²C Interface Timing Diagram

ABSOLUTE MAXIMUM RATINGS

T_A = 25°C, unless otherwise noted.

Table 3.

Parameter	Value
V _{DD} to GND	−0.3 V to +7 V
V _A , V _B , V _W to GND	GND − 0.3 V, V _{DD} + 0.3 V
I _{MAX}	
Pulsed ¹	±20 mA
Continuous	±5 mA
Digital Inputs and Output Voltage to GND	0 V to +7 V
Operating Temperature Range	−40°C to +85°C
Maximum Junction Temperature (T _{JMAX})	150°C
Storage Temperature	−65°C to +150°C
Lead Temperature (Soldering, 10 sec)	300°C
Thermal Resistance ² θ _{JA} : MSOP – 10	200°C/W

¹ Maximum terminal current is bounded by the maximum current handling of the switches, maximum power dissipation of the package, and maximum applied voltage across any two of the A, B, and W terminals at a given resistance.

² Package power dissipation = (T_{JMAX} − T_A)/θ_{JA}.

Stresses above those listed under Absolute Maximum Ratings may cause permanent damage to the device. This is a stress rating only; functional operation of the device at these or any other conditions above those indicated in the operational section of this specification is not implied. Exposure to absolute maximum rating conditions for extended periods may affect device reliability.

ESD CAUTION

ESD (electrostatic discharge) sensitive device. Electrostatic charges as high as 4000 V readily accumulate on the human body and test equipment and can discharge without detection. Although this product features proprietary ESD protection circuitry, permanent damage may occur on devices subjected to high energy electrostatic discharges. Therefore, proper ESD precautions are recommended to avoid performance degradation or loss of functionality.



PIN CONFIGURATION AND FUNCTION DESCRIPTIONS

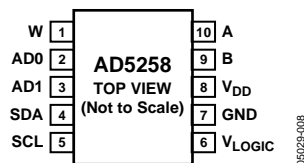

Figure 5. Pin Configuration

Table 4. Pin Function Descriptions

Pin No.	Mnemonic	Description
1	W	W Terminal, $GND \leq V_W \leq V_{DD}$.
2	ADO	Programmable Three-State Address Bit 0 for Multiple Package Decoding. State is registered on power-up.
3	AD1	Programmable Three-State Address Bit 1 for Multiple Package Decoding. State is registered on power-up.
4	SDA	Serial Data Input/Output.
5	SCL	Serial Clock Input. Positive edge triggered.
6	V _{LOGIC}	Logic Power Supply.
7	GND	Digital Ground.
8	V _{DD}	Positive Power Supply.
9	B	B Terminal, $GND \leq V_B \leq V_{DD}$.
10	A	A Terminal, $GND \leq V_A \leq V_{DD}$.

TYPICAL PERFORMANCE CHARACTERISTICS

$V_{DD} = V_{LOGIC} = 5.5\text{ V}$, $R_{AB} = 10\text{ k}\Omega$, $T_A = 25^\circ\text{C}$, unless otherwise noted.

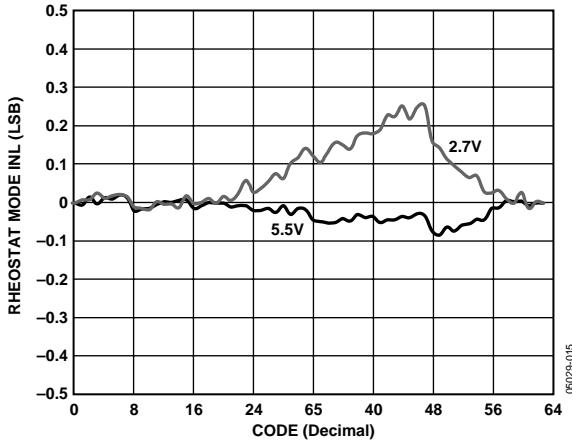

Figure 6. R-INL vs. Code vs. Supply Voltage

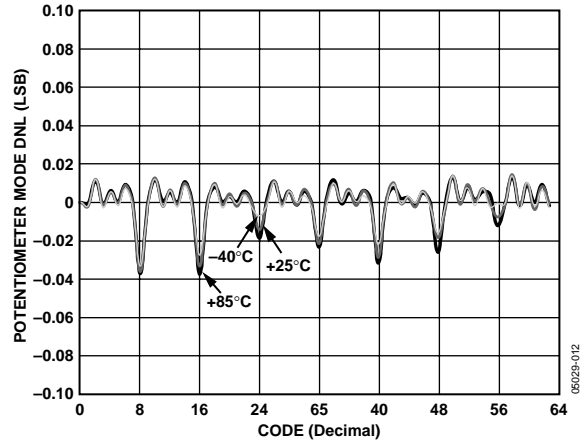

Figure 9. DNL vs. Code vs. Temperature

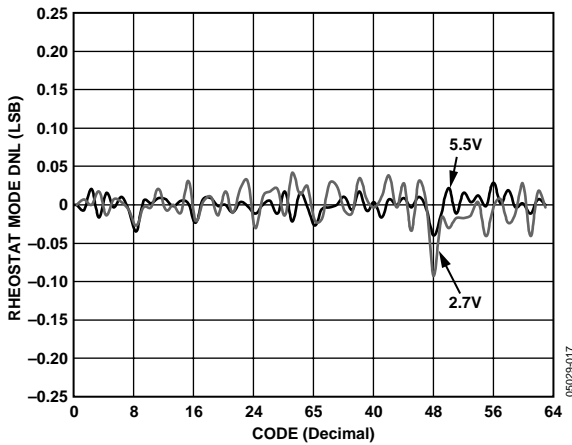

Figure 7. R-DNL vs. Code vs. Supply Voltages

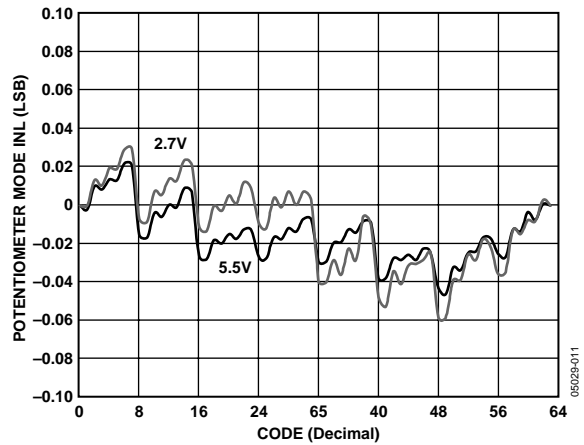

Figure 10. INL vs. Supply Voltages

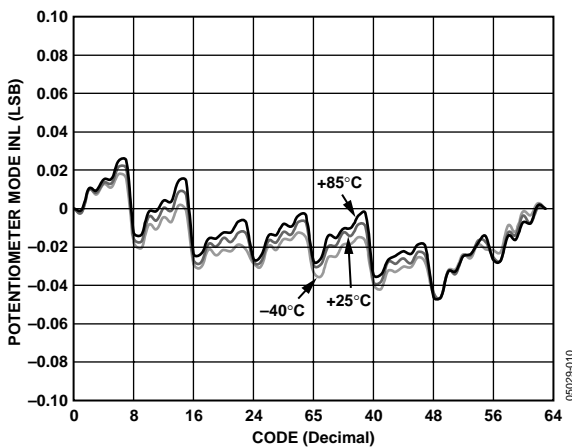

Figure 8. INL vs. Code vs. Temperature

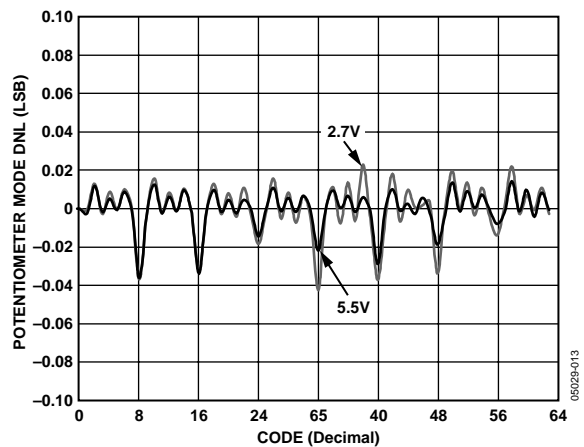

Figure 11. DNL vs. Code vs. Supply Voltages

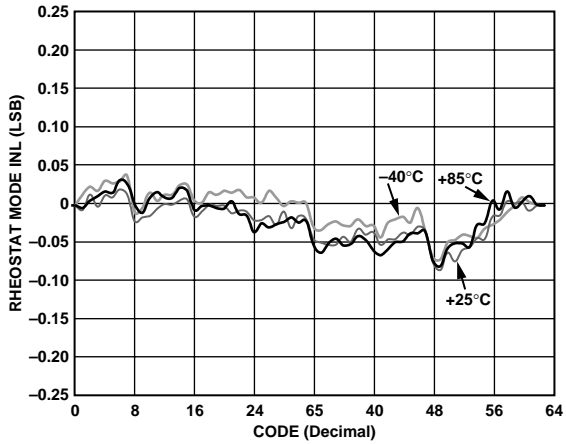

Figure 12. R-INL vs. Code vs. Temperature

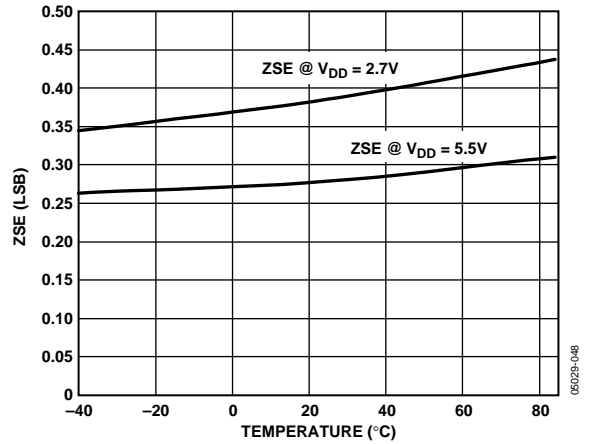

Figure 15. Zero-Scale Error vs. Temperature

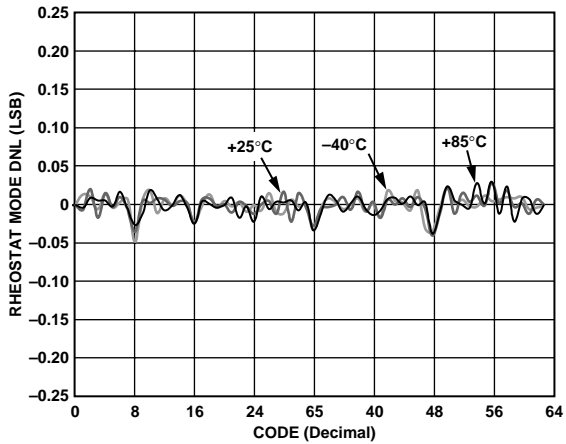

Figure 13. R-DNL vs. Code vs. Temperature

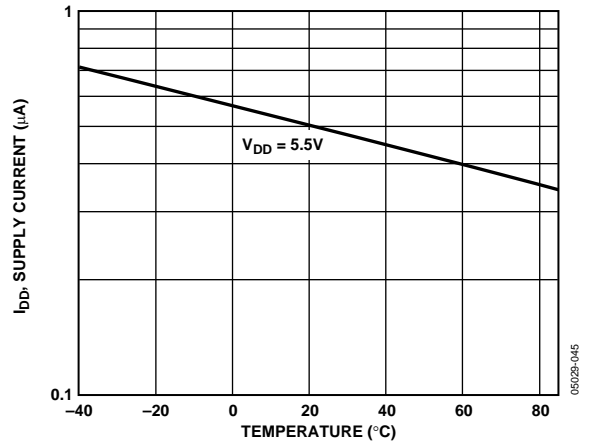

Figure 16. Supply Current vs. Temperature

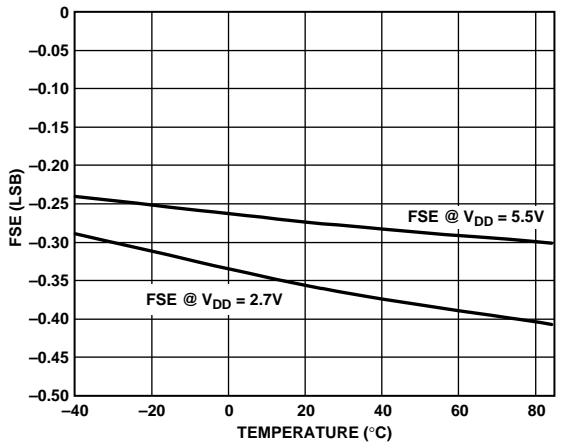

Figure 14. Full-Scale Error vs. Temperature

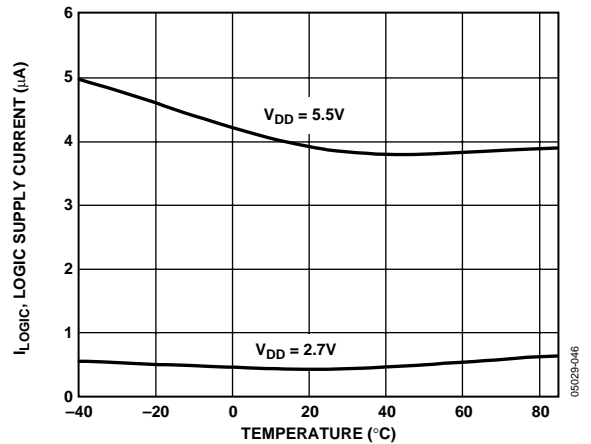

Figure 17. Logic Supply Current vs. Temperature vs. VDD

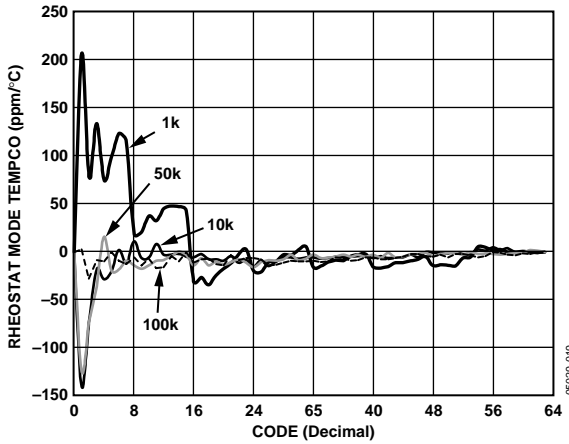

Figure 18. Rheostat Mode Tempco ($\Delta R_{AB} \times 10^6$) / ($R_{AB} \times \Delta T$) vs. Code

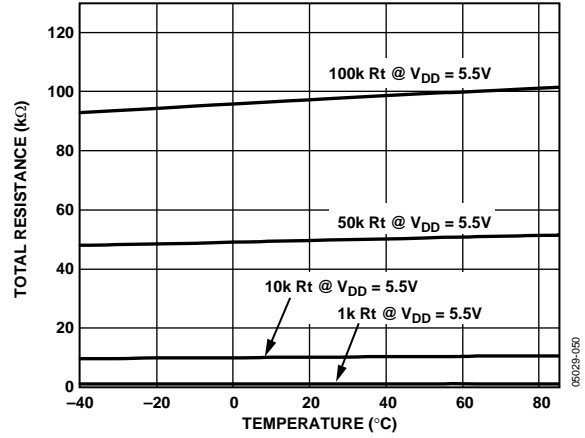

Figure 21. Total Resistance vs. Temperature

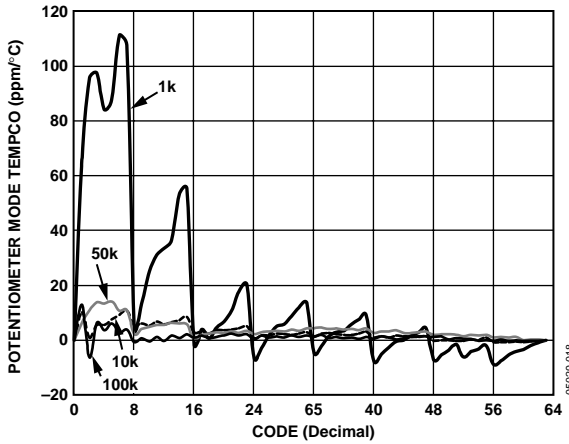

Figure 19. Potentiometer Mode Tempco ($\Delta V_W \times 10^6$) / ($V_W \times \Delta T$) vs. Code

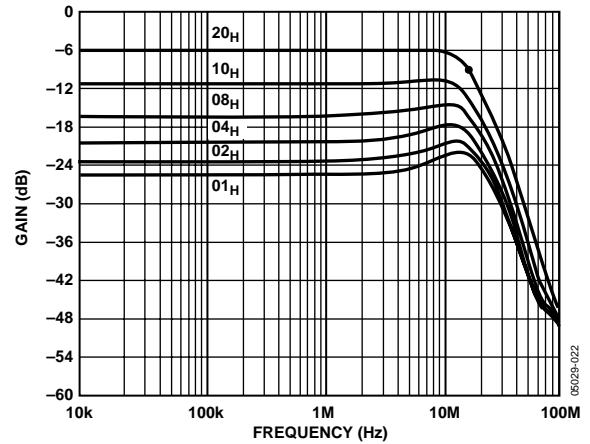

Figure 22. Gain vs. Frequency vs. Code, $R_{AB} = 1 \text{ k}\Omega$

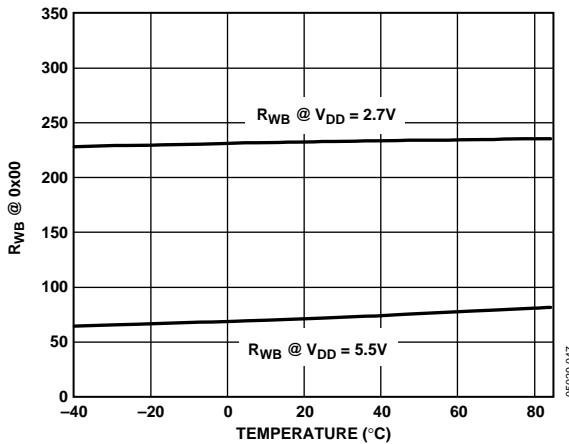

Figure 20. R_{WB} vs. Temperature

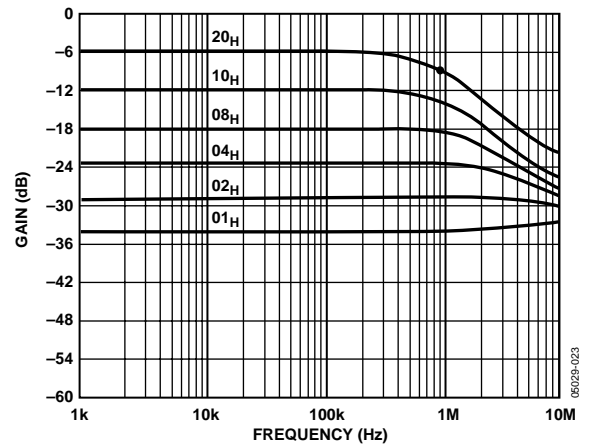

Figure 23. Gain vs. Frequency vs. Code, $R_{AB} = 10 \text{ k}\Omega$

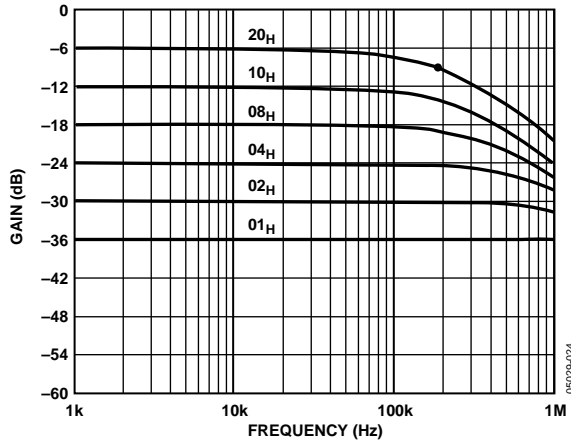

Figure 24. Gain vs. Frequency vs. Code, $R_{AB} = 50\text{ k}\Omega$

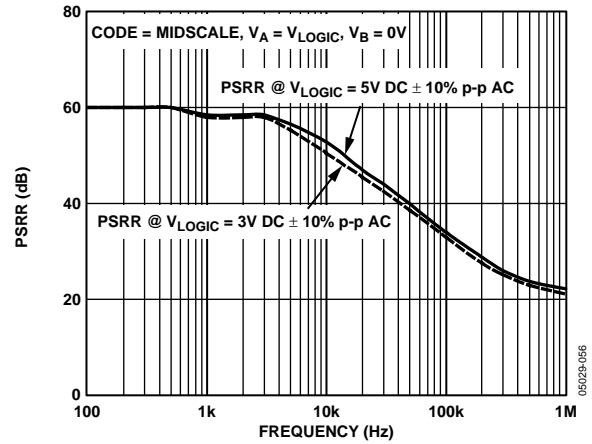

Figure 27. PSRR vs. Frequency

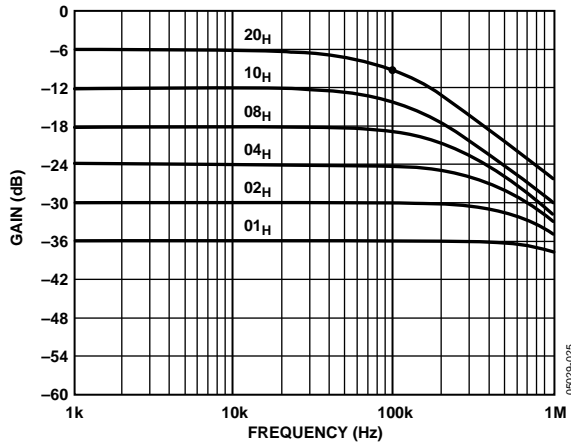

Figure 25. Gain vs. Frequency vs. Code, $R_{AB} = 100\text{ k}\Omega$

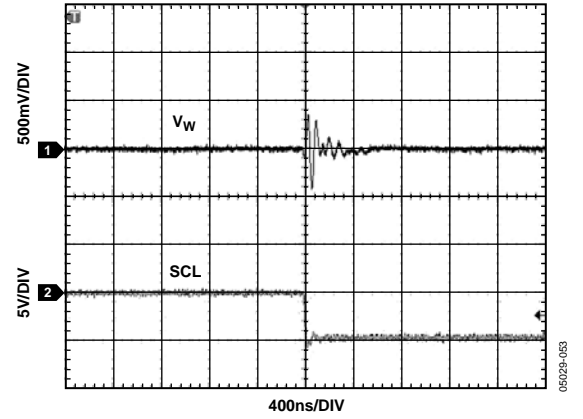

Figure 28. Digital Feedthrough

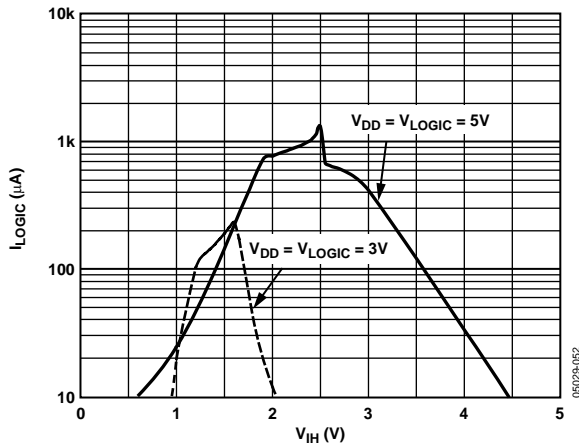

Figure 26. Logic Supply Current vs. Input Voltage

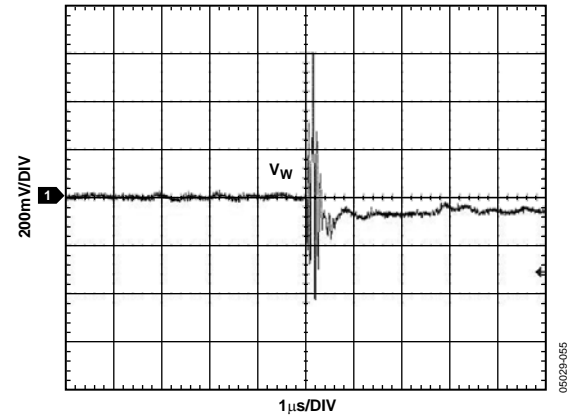

Figure 29. Midscale Glitch, Code 0x7F to 0x80

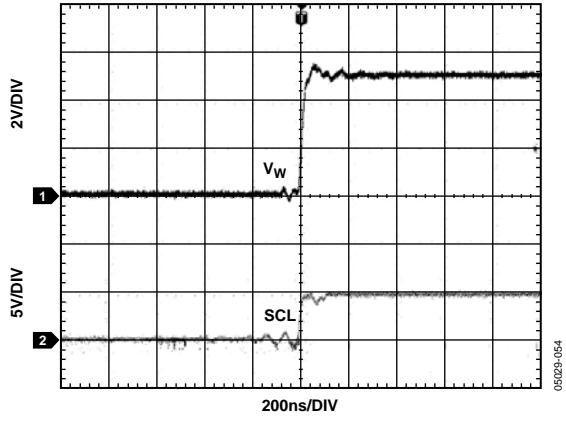

Figure 30. Large Signal Settling Time

TEST CIRCUITS

Figure 31 through Figure 36 illustrate the test circuits that define the test conditions used in the product specification tables.

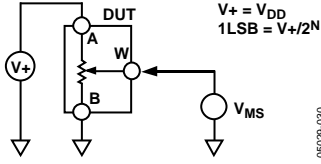

Figure 31. Test Circuit for Potentiometer Divider Nonlinearity Error (INL, DNL)

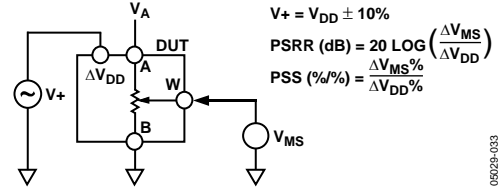

Figure 34. Test Circuit for Power Supply Sensitivity (PSS, PSSR)

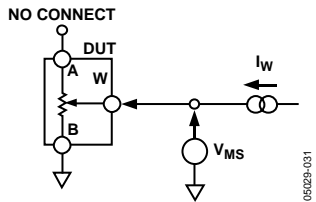

Figure 32. Test Circuit for Resistor Position Nonlinearity Error (Rheostat Operation; R-INL, R-DNL)

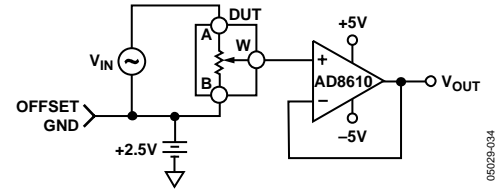

Figure 35. Test Circuit for Gain vs. Frequency

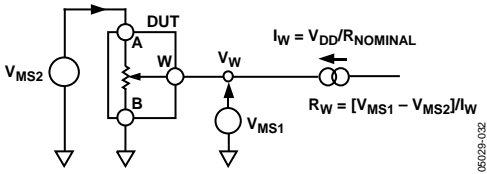

Figure 33. Test Circuit for Wiper Resistance

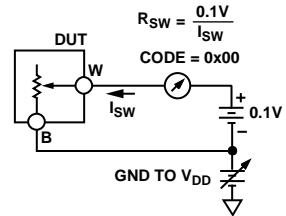

Figure 36. Test Circuit for Common-Mode Leakage Current

THEORY OF OPERATION

The AD5258 is a 64-position digitally controlled variable resistor (VR) device. The wiper's default value, prior to programming the EEPROM, is midscale.

PROGRAMMING THE VARIABLE RESISTOR

Rheostat Operation

The nominal resistance (R_{AB}) of the RDAC between Terminal A and Terminal B is available in 1 k Ω , 10 k Ω , 50 k Ω , and 100 k Ω . The nominal resistance of the VR has 64 contact points accessed by the wiper terminal. The 6-bit data in the RDAC latch is decoded to select one of 64 possible settings.

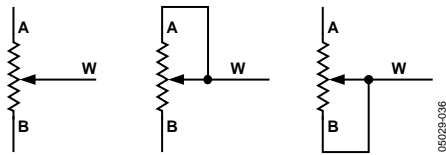

Figure 37. Rheostat Mode Configuration

The general equation determining the digitally programmed output resistance between Wiper W and Terminal B is

$$R_{WB}(D) = \frac{D}{64} \times R_{AB} + 2 \times R_W \quad (1)$$

where:

D is the decimal equivalent of the binary code loaded in the 6-bit RDAC register.

R_{AB} is the end-to-end resistance.

R_W is the wiper resistance contributed by the on resistance of each internal switch.

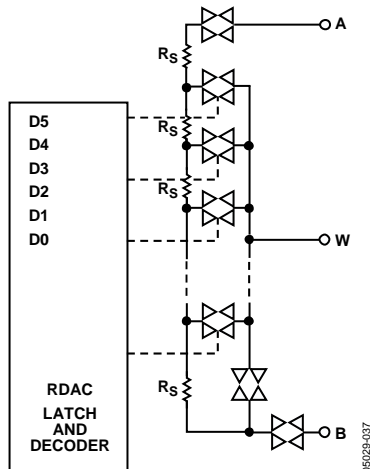

Figure 38. AD5258 Equivalent RDAC Circuit

Note that in the zero-scale condition, there is a relatively low value finite wiper resistance. Care should be taken to limit the current flow between Wiper W and Terminal B in this state to a maximum pulse current of no more than 20 mA. Otherwise, degradation or destruction of the internal switch contact can occur.

Similar to the mechanical potentiometer, the resistance of the RDAC between Wiper W and Terminal A produces a digitally controlled complementary resistance, R_{WA} . The resistance value setting for R_{WA} starts at a maximum value of resistance and decreases as the data loaded in the latch increases in value. The general equation for this operation is

$$R_{WA}(D) = \frac{64 - D}{64} \times R_{AB} + 2 \times R_W \quad (2)$$

Typical device-to-device matching is process lot dependent and may vary by up to $\pm 30\%$. For this reason, resistance tolerance is stored in the EEPROM such that the user will know the actual R_{AB} within 0.1%.

PROGRAMMING THE POTENTIOMETER DIVIDER

Voltage Output Operation

The digital potentiometer easily generates a voltage divider at Wiper W-to-Terminal B and Wiper W-to-Terminal A proportional to the input voltage at Terminal A to Terminal B. Unlike the polarity of V_{DD} to GND, which must be positive, voltage across Terminal A to Terminal B, Wiper W to Terminal A, and Wiper W to Terminal B can be at either polarity.

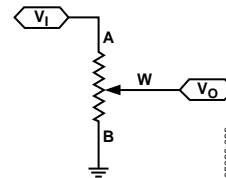

Figure 39. Potentiometer Mode Configuration

If ignoring the effect of the wiper resistance for approximation, connecting the A terminal to 5 V and the B terminal to ground produces an output voltage at Wiper W-to-Terminal B starting at 0 V up to 1 LSB less than 5 V. The general equation defining the output voltage at V_W with respect to ground for any valid input voltage applied to Terminal A and Terminal B is

$$V_W(D) = \frac{D}{64} V_A + \frac{64 - D}{64} V_B \quad (3)$$

A more accurate calculation, which includes the effect of wiper resistance, V_W , is

$$V_W(D) = \frac{R_{WB}(D)}{R_{AB}} V_A + \frac{R_{WA}(D)}{R_{AB}} V_B \quad (4)$$

Operation of the digital potentiometer in the divider mode results in a more accurate operation over temperature. Unlike the rheostat mode, the output voltage is dependent mainly on the ratio of the Internal Resistors, R_{WA} and R_{WB} , and not the absolute values.

I²C INTERFACE

Note that the wiper's default value, prior to programming the EEPROM, is midscale.

1. The master initiates data transfer by establishing a START condition when a high-to-low transition on the SDA line occurs while SCL is high (see Figure 4). The next byte is the slave address byte, which consists of the slave address (first 7 bits) followed by an $\overline{R/W}$ bit (see Table 6). When the $\overline{R/W}$ bit is high, the master reads from the slave device. When the $\overline{R/W}$ bit is low, the master writes to the slave device.

The slave address of the part is determined by two three-state-configurable Address Pins AD0 and AD1. The state of these two pins is registered upon power-up and decoded into a corresponding I²C 7-bit address (see Table 5). The slave address corresponding to the transmitted address bits responds by pulling the SDA line low during the ninth clock pulse (this is termed the slave acknowledge bit).

At this stage, all other devices on the bus remain idle while the selected device waits for data to be written to, or read from, its serial register.

2. **Writing:** In the write mode, the last bit ($\overline{R/W}$) of the slave address byte is logic low. The second byte is the instruction byte. The first three bits of the instruction byte are the command bits (see Table 6). The user must choose whether to write to the RDAC register, EEPROM register, or activate the software write protect (see Table 7 to Table 10). The final five bits are all zeros (see Table 13 to Table 14). The slave again responds by pulling the SDA line low during the ninth clock pulse.

The final byte is the data byte MSB first. Don't cares can be left either high or low. In the case of the write protect mode, data is not stored; rather, a logic high in the LSB enables write protect. Likewise, a logic low will disable write protect. The slave again responds by pulling the SDA line low during the ninth clock pulse.

3. **Storing/Restoring:** In this mode, only the address and instruction bytes are necessary. The last bit ($\overline{R/W}$) of the address byte is logic low. The first three bits of the instruction byte are the command bits (see Table 6). The two choices are transfer data from RDAC to EEPROM

(store), or from EEPROM to RDAC (restore). The final five bits are all zeros (see Table 13 to Table 14).

4. **Reading:** Assuming the register of interest was not just written to, it is necessary to write a dummy address and instruction byte. The instruction byte will vary depending on whether the data that is wanted is the RDAC register, EEPROM register, or tolerance register (see Table 11 to Table 16).

After the dummy address and instruction bytes are sent, a repeat start is necessary. After the repeat start, another address byte is needed, except this time the $\overline{R/W}$ bit is logic high. Following this address byte is the readback byte containing the information requested in the instruction byte. Read bits appear on the negative edges of the clock. Don't cares may either be in a high or low state.

The tolerance register can be read back individually (see Table 15) or consecutively (see Table 16). Refer to the Read Modes section for detailed information on the interpretation of the tolerance bytes.

5. After all data bits have been read or written, a STOP condition is established by the master. A STOP condition is defined as a low-to-high transition on the SDA line while SCL is high. In write mode, the master pulls the SDA line high during the tenth clock pulse to establish a STOP condition (see Figure 45). In read mode, the master issues a no acknowledge for the ninth clock pulse (that is, the SDA line remains high). The master then brings the SDA line low before the tenth clock pulse, and then raises SDA high to establish a STOP condition (see Figure 46).

A repeated write function gives the user flexibility to update the RDAC output a number of times after addressing and instructing the part only once. For example, after the RDAC has acknowledged its slave address and instruction bytes in the write mode, the RDAC output is updated on each successive byte until a STOP condition is received. If different instructions are needed, the write/read mode has to start again with a new slave address, instruction, and data byte. Similarly, a repeated read function of the RDAC is also allowed.

AD5258

I²C BYTE FORMATS

The following generic, write, read, and store/restore control registers for the AD5258 all refer to the device addresses listed in Table 5, and the mode/condition reference key (S, P, SA, MA, NA, \overline{W} , R, and X) listed below.

S = Start Condition

P = Stop Condition

SA = Slave Acknowledge

MA = Master Acknowledge

NA = No Acknowledge

\overline{W} = Write

R = Read

X = Don't Care

Table 5. Device Address Lookup

AD1 and AD0 are three-state address pins.

Device Address	AD1	AD0
0011000	0	0
0011001	NC	0
0011010	1	0
0101001	0	NC
0101010	NC	NC
0101011	1	NC
1001100	0	1
1001101	NC	1
1001110	1	1

GENERIC INTERFACE

Table 6. Generic Interface Format

S	7-Bit Device Address (See Table 5)	$\overline{R/\overline{W}}$	SA	C2	C1	C0	A4	A3	A2	A1	A0	SA	D7	D6	D5	D4	D3	D2	D1	D0	SA	P
	Slave Address Byte			Instruction Byte									Data Byte									

Table 7. RDAC-to-EEPROM Interface Command Descriptions

C2	C1	C0	Command Description
0	0	0	Operation between I ² C and RDAC
0	0	1	Operation between I ² C and EEPROM
0	1	0	Operation between I ² C and Write Protection Register. See Table 10.
1	0	0	NOP
1	0	1	Restore EEPROM to RDAC
1	1	0	Store RDAC to EEPROM

WRITE MODES

Table 8. Writing to RDAC Register

S	7-Bit Device Address (See Table 5)	0	SA	0	0	0	0	0	0	0	0	0	0	SA	X	X	D5	D4	D3	D2	D1	D0	SA	P
Slave Address Byte			Instruction Byte										Data Byte											

Table 9. Writing to EEPROM Register

S	7-Bit Device Address (See Table 5)	0	SA	0	0	1	0	0	0	0	0	0	0	SA	X	X	D5	D4	D3	D2	D1	D0	SA	P
Slave Address Byte			Instruction Byte										Data Byte											

The wiper's default value, prior to programming the EEPROM, is midscale.

Table 10. Activating/Deactivating Software Write Protect

S	7-Bit Device Address (See Table 5)	0	SA	0	1	0	0	0	0	0	0	0	0	SA	0	0	0	0	0	0	0	0	WP	SA	P
Slave Address Byte			Instruction Byte										Data Byte												

In order to activate the write protection mode, the WP bit in Table 10 must be logic high. In order to deactivate the write protection, the command must be sent again except with the WP in logic zero state.

READ MODES

Read modes are referred to as traditional because the first two bytes for all three cases are “dummy” bytes which function to place the pointer towards the correct register. This is the reason for the repeat start. In theory, this step can be avoided if the user is interested in reading a register that was previously

written to. For example, if the EEPROM was just written to, then the user can skip the two dummy bytes and proceed directly to the slave address byte followed by the EEPROM readback data.

Table 11. Traditional Readback of RDAC Register Value

S	7-Bit Device Address (See Table 5)	0	SA	0	0	0	0	0	0	0	0	0	SA	S	7-Bit Device Address (See Table 5)	1	SA	X	X	D5	D4	D3	D2	D1	D0	NA	P
Slave Address Byte			Instruction Byte										Slave Address Byte			Read Back Data											

↑
Repeat start

Table 12. Traditional Readback of Stored EEPROM Value

S	7-Bit Device Address (See Table 5)	0	SA	0	0	1	0	0	0	0	0	0	SA	S	7-Bit Device Address (See Table 5)	1	SA	X	X	D5	D4	D3	D2	D1	D0	NA	P
Slave Address Byte			Instruction Byte										Slave Address Byte			Read Back Data											

↑
Repeat start

STORE/RESTORE MODES

Table 13. Storing RDAC Value to EEPROM

S	7-Bit Device Address (See Table 5)	0	SA	1	1	0	0	0	0	0	0	0	SA	P
Slave Address Byte			Instruction Byte											

Table 14. Restoring EEPROM to RDAC

S	7-Bit Device Address (See Table 5)	0	SA	1	0	1	0	0	0	0	0	0	SA	P
Slave Address Byte			Instruction Byte											

TOLERANCE READBACK MODES

Table 15. Traditional Readback of Tolerance (Individually)

7-Bit Device Address (See Table 5)		0	SA	0	0	1	1	1	1	1	0	SA	S	7-Bit Device Address (See Table 5)		1	SA	D7	D6	D5	D4	D3	D2	D1	D0	NA	P
Slave Address Byte				Instruction Byte									Slave Address Byte				Sign + Integer Byte										

↑
Repeat start

7-Bit Device Address (See Table 5)		0	SA	0	0	1	1	1	1	1	1	0	SA	S	7-Bit Device Address (See Table 5)		1	SA	D7	D6	D5	D4	D3	D2	D1	D0	NA	P
Slave Address Byte				Instruction Byte									Slave Address Byte				Decimal Byte											

↑
Repeat start

Table 16. Traditional Readback of Tolerance (Consecutively)

7-Bit Device Address (See Table 5)		0	SA	0	0	1	1	1	1	1	0	SA	S	7-Bit Device Address (See Table 5)		1	SA	D7	D6	D5	D4	D3	D2	D1	D0	MA	D7	D6	D5	D4	D3	D2	D1	D0	NA	P
Slave Address Byte				Instruction Byte									Slave Address Byte				Sign + Integer Byte							Decimal Byte												

↑
Repeat start

Calculating R_{AB} Tolerance Stored in Read-Only Memory

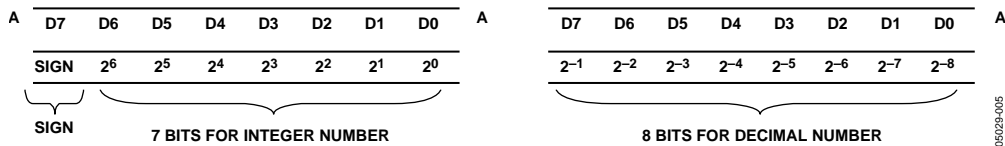

Figure 40. Format of Stored Tolerance in Sign Magnitude Format with Bit Position Descriptions. (Unit is Percent. Only Data Bytes are Shown.)

The AD5258 features a patented R_{AB} tolerance storage in the nonvolatile memory. The tolerance is stored in the memory during factory production and can be read by users at any time. The knowledge of stored tolerance allows users to accurately calculate R_{AB} . This feature is valuable for precision, rheostat mode, and open-loop applications where knowledge of absolute resistance is critical.

The stored tolerance resides in the read-only memory and is expressed as a percentage. The tolerance is stored in two memory location bytes in sign magnitude binary form (see Figure 40). The two EEPROM address bytes are 11110 (sign + integer) and 11111 (decimal number). The two bytes can be individually accessed with two separate commands (see Table 15). Alternatively, readback of the first byte followed by the second byte can be done in one command (see Table 16). In the latter case, the memory pointer will automatically increment from the first to

the second EEPROM location (increments from 11110 to 11111) if read consecutively.

In the first memory location, the MSB is designated for the sign (0 = + and 1 = -) and the seven LSBs are designated for the integer portion of the tolerance. In the second memory location, all eight data bits are designated for the decimal portion of tolerance. Note that the decimal portion has a limited accuracy of only 0.1%. For example, if the rated $R_{AB} = 10 \text{ k}\Omega$ and the data readback from Address 11110 shows 0001 1100, and Address 11111 shows 0000 1111, then the tolerance can be calculated as

$$\begin{aligned} \text{MSB: } 0 &= + \\ \text{Next 7 MSB: } 001\ 1100 &= 28 \\ \text{8 LSB: } 0000\ 1111 &= 15 \times 2^{-8} = 0.06 \\ \text{Tolerance} &= +28.06\% \\ \text{Rounded Tolerance} &= +28.1\% \text{ and therefore,} \\ R_{AB_ACTUAL} &= 12.810 \text{ k}\Omega \end{aligned}$$

ESD PROTECTION OF DIGITAL PINS AND RESISTOR TERMINALS

The AD5258 V_{DD} , V_{LOGIC} , and GND power supplies define the boundary conditions for proper 3-terminal and digital input operation. Supply signals present on Terminal A, Terminal B, and Terminal W that exceed V_{DD} or GND are clamped by the internal forward biased ESD protection diodes (see Figure 41). Digital Input SCL and Digital Input SDA are clamped by ESD protection diodes with respect to V_{LOGIC} and GND as shown in Figure 42.

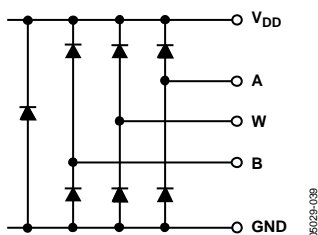

Figure 41. Maximum Terminal Voltages Set by V_{DD} and GND

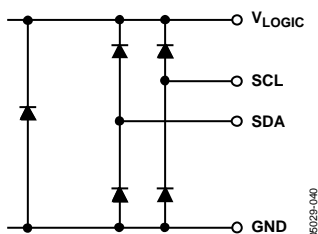

Figure 42. Maximum Terminal Voltages Set by V_{LOGIC} and GND

POWER-UP SEQUENCE

Because the ESD protection diodes limit the voltage compliance at Terminal A, Terminal B, and Terminal W (see Figure 41), it is important to power GND/ V_{DD} / V_{LOGIC} before applying any voltage to Terminal A, Terminal B, and Terminal W; otherwise, the diode is forward biased such that V_{DD} and V_{LOGIC} are powered unintentionally and may affect the user's circuit. The ideal power-up sequence is in the following order: GND, V_{DD} , V_{LOGIC} , digital inputs, and then V_A , V_B , V_W . The relative order of powering V_A , V_B , V_W , and the digital inputs is not important as long as they are powered after GND/ V_{DD} / V_{LOGIC} .

LAYOUT AND POWER SUPPLY BYPASSING

It is good practice to employ compact, minimum lead length layout design. The leads to the inputs should be as direct as possible with minimum conductor length. Ground paths should have low resistance and low inductance.

Similarly, it is also good practice to bypass the power supplies with quality capacitors for optimum stability. Supply leads to the device should be bypassed with disc or chip ceramic capacitors of 0.01 μF to 0.1 μF . Low ESR 1 μF to 10 μF tantalum or electrolytic capacitors should also be applied at the supplies to minimize any transient disturbance and low frequency ripple (see Figure 43). The digital ground should also be joined remotely to the analog ground at one point to minimize the ground bounce.

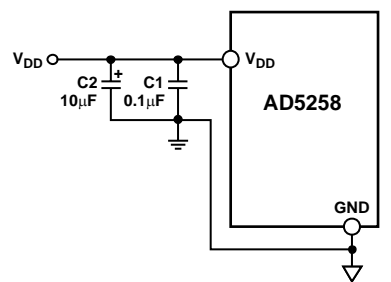

Figure 43. Power Supply Bypassing

MULTIPLE DEVICES ON ONE BUS

The AD5258 has two three-state configurable Address Pins AD0 and AD1. The state of these two pins is registered upon power-up and decoded into a corresponding I²C 7-bit address (see Table 5). This allows up to nine devices on the bus to be written to, or read from, independently. In the case that the pin is assigned to be floated, the static voltage will be $V_{LOGIC}/2$.

EVALUATION BOARD

An evaluation board, along with all necessary software, is available to program the AD5258 from any PC running Windows® 98/2000/XP. The graphical user interface, as shown in Figure 44, is straightforward and easy to use. More detailed information is available in the user manual that comes with the board.

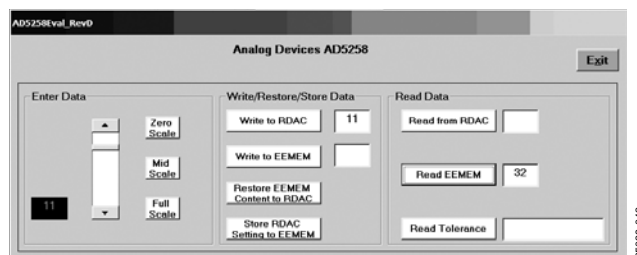

Figure 44. AD5258 Evaluation Board Software

DISPLAY APPLICATIONS

CIRCUITRY

A special feature of the AD5258 is its unique separation of the V_{LOGIC} and V_{DD} supply pins. The reason for doing this is to provide greater flexibility in applications that do not always provide needed supply voltages.

In particular, LCD panels often require a V_{COM} voltage in the range of 3 V to 5 V. The circuit in Figure 45 is the rare exception in which a 5 V supply is available to power the digital potentiometer.

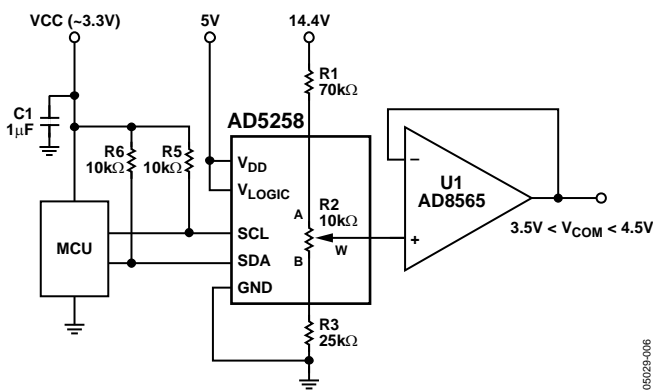

Figure 45. V_{COM} Adjustment Application

In the more common case shown in Figure 46, only analog 14.4 V and digital logic 3.3 V supplies are available. By placing discrete resistors above and below the digital pot, V_{DD} can now be tapped off the resistor string itself. Based on the chosen resistor values, the voltage at V_{DD} in this case equals 4.8 V, allowing the wiper to be safely operated all the way up to 4.8 V. The current draw of

V_{DD} will not affect that node's bias because it is only on the order of microamps. V_{LOGIC} is tied to the MCU's 3.3 V digital supply because V_{LOGIC} will draw the 35 mA which is needed when writing to the EEPROM. It would be impractical to try and source 35 mA through the 70 kΩ resistor, therefore, V_{LOGIC} is not connected to the same node as V_{DD} .

For this reason, V_{LOGIC} and V_{DD} are provided as two separate supply pins that can either be tied together or treated independently; V_{LOGIC} supplying the logic/EEPROM with power, and V_{DD} biasing up the A, B, and W terminals for added flexibility.

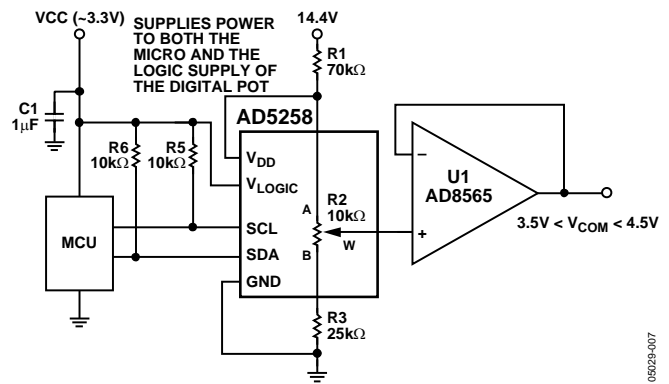

Figure 46. Circuitry When a Separate Supply is Not Available for V_{DD}

For a more detailed look at this application, refer to the article, "Simple V_{COM} Adjustment uses any Logic Supply Voltage" in the September 30, 2004, issue of *EDN* magazine.

OUTLINE DIMENSIONS

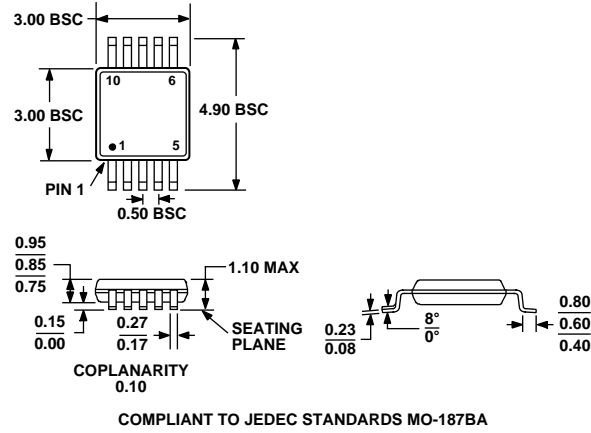

Figure 47. 10-Lead Mini Small Outline Package [MSOP] (RM-10)
Dimensions shown in millimeters

ORDERING GUIDE

Model	R _{AB} (Ω)	Temperature	Package Description	Package Option	Branding
AD5258BRMZ1 ¹	1 k	-40°C to +85°C	MSOP-10	RM-10	D4K
AD5258BRMZ1-R7 ¹	1 k	-40°C to +85°C	MSOP-10	RM-10	D4K
AD5258BRMZ10 ¹	10 k	-40°C to +85°C	MSOP-10	RM-10	D4L
AD5258BRMZ10-R7 ¹	10 k	-40°C to +85°C	MSOP-10	RM-10	D4L
AD5258BRMZ50 ¹	50 k	-40°C to +85°C	MSOP-10	RM-10	D4M
AD5258BRMZ50-R7 ¹	50 k	-40°C to +85°C	MSOP-10	RM-10	D4M
AD5258BRMZ100 ¹	100 k	-40°C to +85°C	MSOP-10	RM-10	D4N
AD5258BRMZ100-R7 ¹	100 k	-40°C to +85°C	MSOP-10	RM-10	D4N
AD5258EVAL ²			Evaluation Board		

¹ Z = Pb-free part.

² The evaluation board is shipped with the 10 kΩ R_{AB} resistor option; however, the board is compatible with all available resistor value options.

AD5258

NOTES

NOTES

AD5258

NOTES

Purchase of licensed I²C components of Analog Devices or one of its sublicensed Associated Companies conveys a license for the purchaser under the Philips I²C Patent Rights to use these components in an I²C system, provided that the system conforms to the I²C Standard Specification as defined by Philips.

© 2005 Analog Devices, Inc. All rights reserved. Trademarks and registered trademarks are the property of their respective owners.
D05029-0-3/05(0)



www.analog.com