

A Step Above the Rest

Bulletin 160 Smart Speed Controller (SSC™)

When the Bulletin 160 SSC was first introduced in the market, its innovative design helped set the standard for future microdrives. With the new Series C design, expanded power ratings (through 5 HP, 4kW), increased functionality and an enhanced hardware design place the Bulletin 160 SSC a "Step Above the Rest" for small AC drive applications!

Hardware Design Features

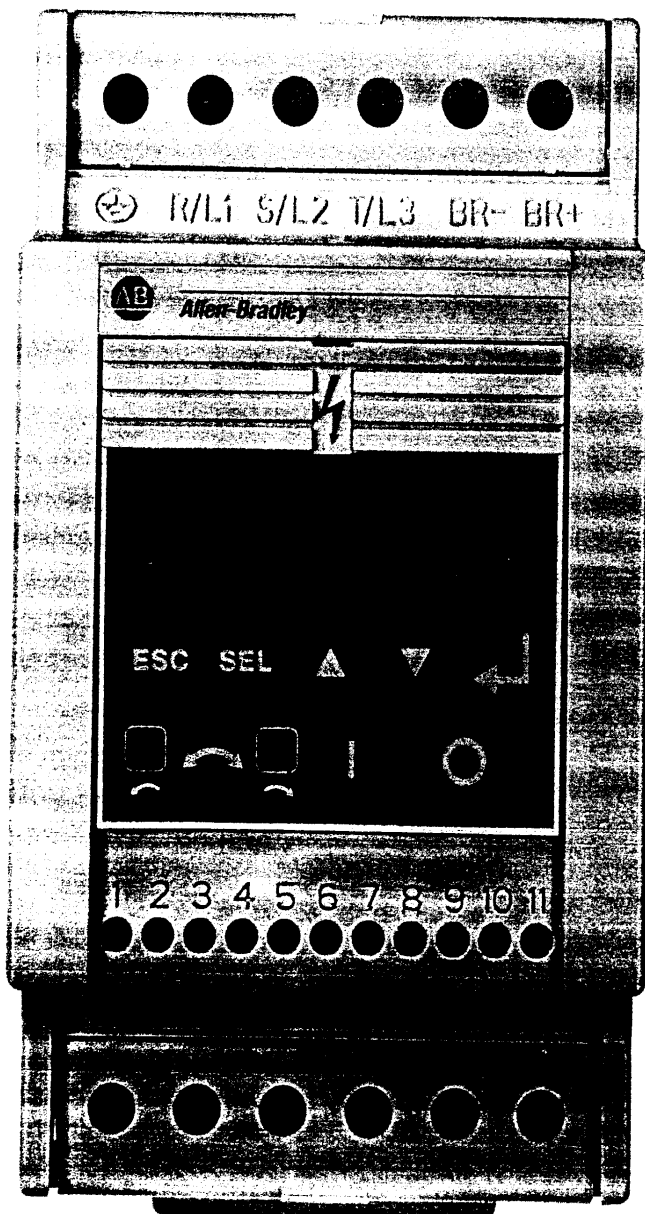

Feed Through 6-Pole Power Terminals **NEW**

Simplifies power wiring and grounding practices making the Bulletin 160 SSC the ideal choice for constant speed retrofits.

Hinged Terminal Guards **NEW**

Allows easy access to power terminals. Terminal screws can be easily removed for ring lug connections.

Program Keypad Module

Provides local control and offers access to all program and display parameters.

DIN Rail or Panel Attachable

Permits quick, low cost installation, fits on standard 35mm DIN rail and follows standard DIN dimensions.

Programmable Output

(N.O./N.C. contact) Connects to your controls/indicators for monitoring specific drive/load conditions.

Programmable Terminal Block

Provides flexibility in meeting a variety of applications without requiring additional external control logic.

A Variety of Styles

IP20 (Open Style) Drives

Feed through power wiring, DIN rail attachable and small package size make this design the ideal choice for conventional control panel layouts. With an overall width that is unrivaled throughout its power ratings, the control panel size can be greatly reduced resulting in significant cost savings.

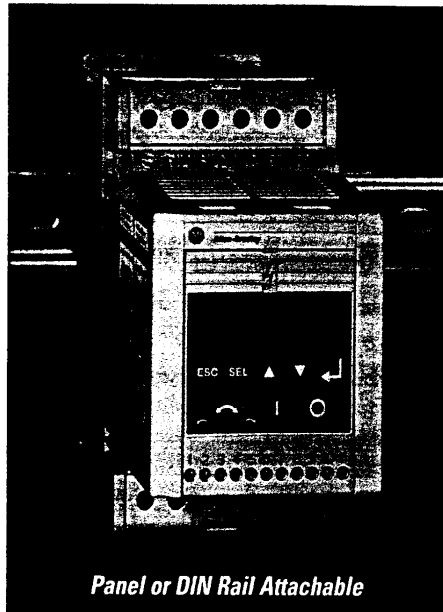

Panel or DIN Rail Attachable

0.5 to 3HP, (0.37 to 2.2kW) 3 Phase
0.5 to 1HP (0.37 to .75kW) 1 Phase
200-230VAC and 380-460VAC

NEW

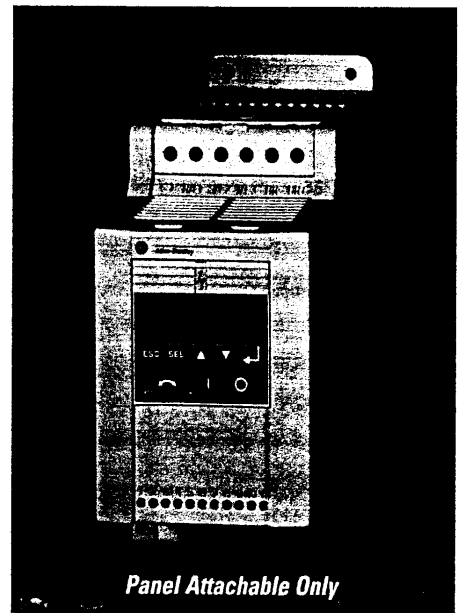

Panel Attachable Only

5HP (4.0kW) 3 Phase
2HP (1.5kW) 1 Phase
200-230VAC and 380-460VAC



IP20 (Chassis Mount) Drives

The externally attached heatsink design reduces the drive's overall power dissipation by approximately 75% compared to the "open style" design. This greatly reduces the overall enclosure size making it an excellent choice for OEM equipment where panel size is limited. The gasketed heatsink assembly meets IP66 (NEMA Type 4/12 or 4X) environmental ratings when installed in an enclosure of like rating.

IP66 (NEMA Type 4/12 and 4x) Configured Drives

If you are looking for a single source solution to your variable speed requirements, look no further. Our Configured Drives product offering has many standard options such as fused disconnects, pilot lights, selector switches and DeviceNet™ communications to name a few. In addition, custom enclosures and controls are also available to meet your specific requirements.

Note: The Configured Drives program shown in this publication is typical of North America. Other locations should contact their local Rockwell Automation office for availability of individual products.

Excellent Control Flexibility

Simplicity, flexibility and ease of use are the foundation of the Bulletin 160 SSC design. We accomplish this through two control models, Analog Signal Follower and Preset Speed. Each control model has a programmable terminal block providing the flexibility to meet a wide array of applications without the use of external control logic.

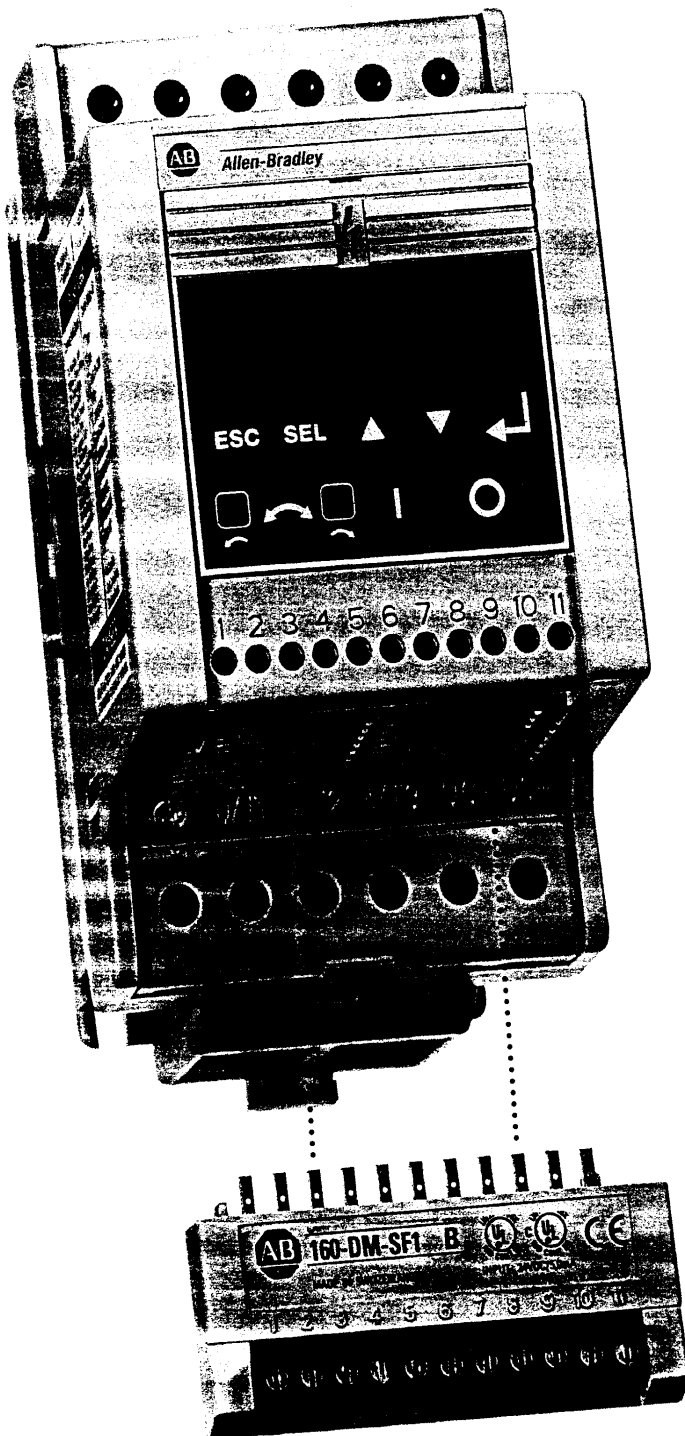

Analog Signal Follower Model

The speed reference can be controlled via a $\pm 10V$, 0-10V or 4-20mA analog signal or a remote potentiometer. The following additional control methods can be attained by programming the control terminal block:

- Preset Speed Control – four preset speeds can be attained for applications where only digital inputs are available. **NEW**
- PI Control – simple closed loop process control can be achieved by using an analog feedback signal as the master speed reference. **NEW**
- Analog Control with One Preset – the command frequency can be switched from analog to one preset speed via a digital input providing application flexibility. **NEW**

Preset Speed Model

For applications where more than four presets are required or additional control flexibility is needed, the Preset Speed Model may be the answer. This model is controlled via three digital inputs that provide eight independent preset speeds and two speed dependent accel/decel ramp times.

Optional 24VDC Interface Module

Digital control inputs should be either dry contact closure or open collector outputs, however, if 24V control is required an optional interface module can be used to accept 24V "sink logic" inputs.

Outstanding Application Versatility

The Bulletin 160 SSC is an excellent choice for applications controlled by an analog signal

Fans & Pumps

Refrigeration
HVAC
Paint Booths
Metering
Vent Hoods
Slurry
Exhaust
Injection
Clean Room (PI)

Machine Tool

Lathes
Saws
Milling Machines
Woodworking
Drill Presses
Grinders

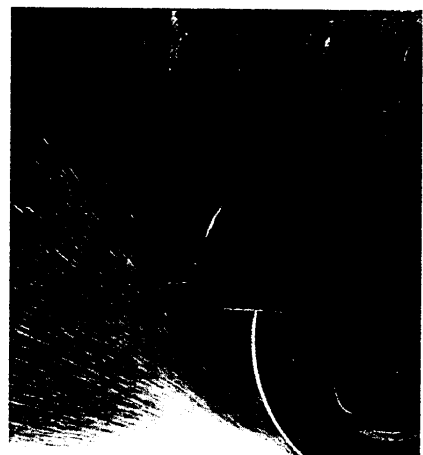
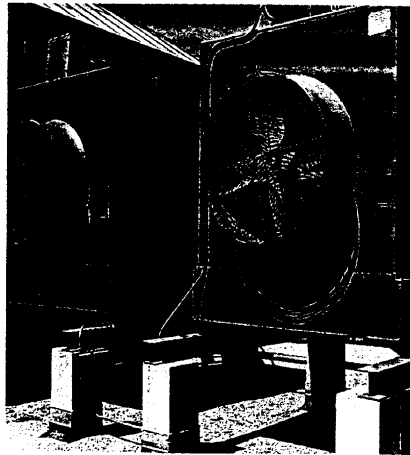

And many other applications where analog control signals are used.

In applications where multiple specific preset speeds are required, the Bulletin 160 SSC can be the solution

Manufacturing & Material Handling

Conveyors
Monorails
Packaging
Trolleys
Winders
Palletizers
Mixers
Feeders

Commercial Applications

Laundry Machines
Automatic Car Washes
Automatic Doors
Dock Levelers

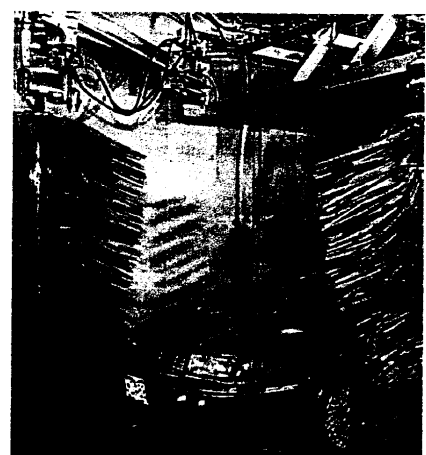

And many other applications where digital control inputs are used.

Simple Operator Interface

Start up is made simple using one of four different operator interface devices. The four options are:

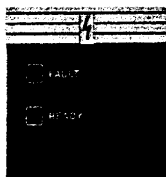

Ready/Fault Panel

Provided as standard equipment, this control panel tells the operator whether the drive is *Ready* for operation or if a *Fault* condition is present. An ideal, low cost solution to applications where parameter monitoring is not required and parameter adjustments are unwanted.

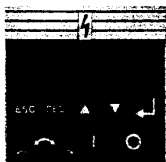

Program Keypad Module

Ordered separately or as a factory installed option, this interface provides the ability to monitor and/or change all drive parameters as well as provide local keypad control (start, stop, reverse). This module also reports specific fault codes, input status and drive status information that can be used in performing diagnostics and troubleshooting.

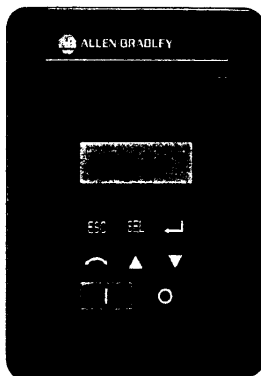

Remote Keypad Module **NEW**

Panel design is simplified using this remote mounted interface. Designed to meet IP65 (NEMA Type 4) requirements, this module can be used in place of separate panel attached control inputs. This reduces installation time and minimizes control wiring.

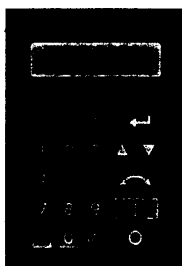

CopyCat Keypad Module **NEW**

Parameter programming is simplified using this hand held programming interface. Parameters can be uploaded and downloaded saving valuable installation time and ensuring accurate, repeatable setup.

Cost Effective Communications

Optional DeviceNet™ and RS232 communication modules provide a low cost solution for control and monitoring the drive. These modules attach directly to the front of the drive (in place of the Program Keypad Module or Ready/Fault Panel) adding less than 1" (25mm) to the overall depth. This reduces installation time and saves valuable panel space.

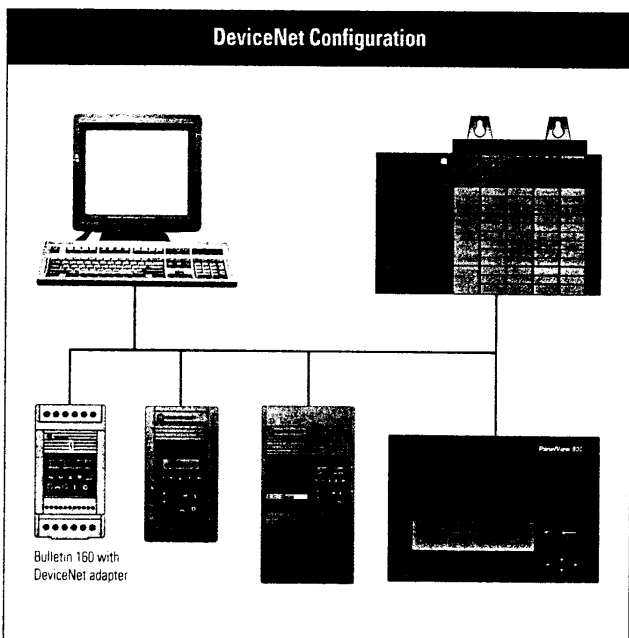

DeviceNet Communication Module

- EDS files are self-generated (using DeviceNet Manager Software) helping to simplify DeviceNet connectivity. **NEW**
- Node address and baud rate can be set via DIP switches.
- DIP switch factory defaults allow node address and baud rate to be configured via the network.
- Offers tremendous flexibility to interface with various Allen-Bradley Products.

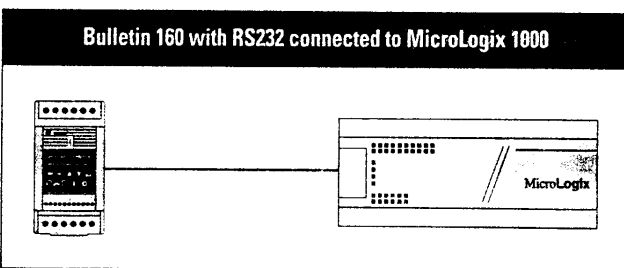

RS-232 Communication Module **NEW**

- Provides serial interface to SLC 500™, PLC®, MicroLogix™ or any computer using DF-1 protocol!
- Supports Point-to-Point communications for easy, fast and low cost data examination.
- Supports Multi-Drop RS-485 Network configuration with the use of 1761-AIC+ modules.
- Can be used with DriveExplorer™ or DriveTools 32™ software for uploading, downloading or monitoring drive parameters.

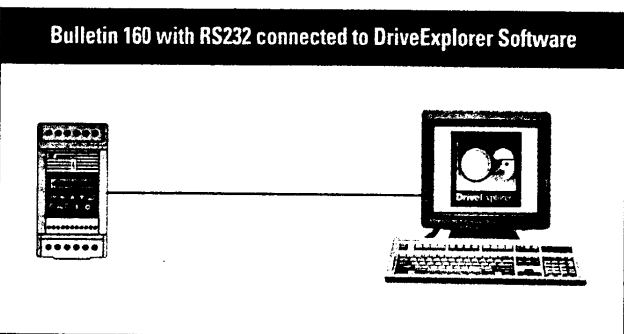

Outstanding Performance

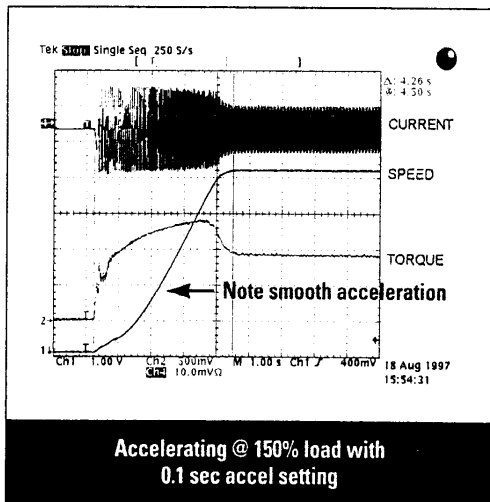

Acceleration Performance

Excellent current regulation allows faster acceleration which results in more cycles per hour. Smooth, controlled current and torque reduce undesirable mechanical vibrations. This helps prolong equipment and motor life. The hybrid current limit function utilizes both firmware and hardware control to minimize the possibility of nuisance trips during fast accelerations, constant speed operation and deceleration.

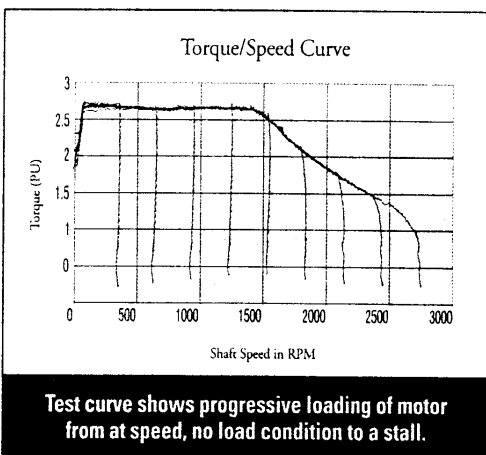

Torque/Speed Performance

The Auto-Boost feature (IR Compensation) automatically adjusts output voltage to improve low speed torque performance. Improved torque performance is maintained across the entire speed range.

The Slip Compensation feature helps improve overall speed regulation. This allows the drive to help maintain the desired commanded output frequency even as loading increases.

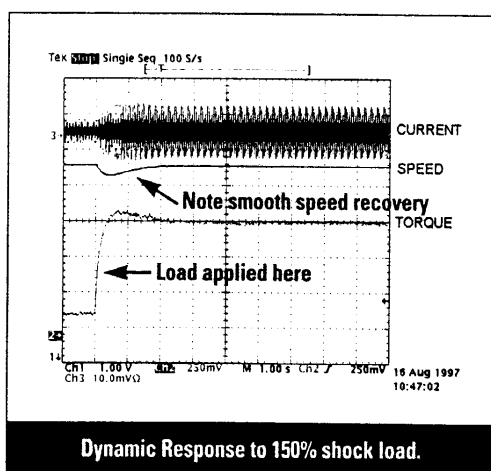

Response to Load Change

The Slip Compensation feature and Hybrid Current Limit function allow the drive to maintain control of current and speed. This helps avoid nuisance tripping and improve process efficiency. Even with shock loads demanding 150% torque, the Bulletin 160 SSC maintains tight control of both current and speed.

Reduced Maintenance and Operational Costs

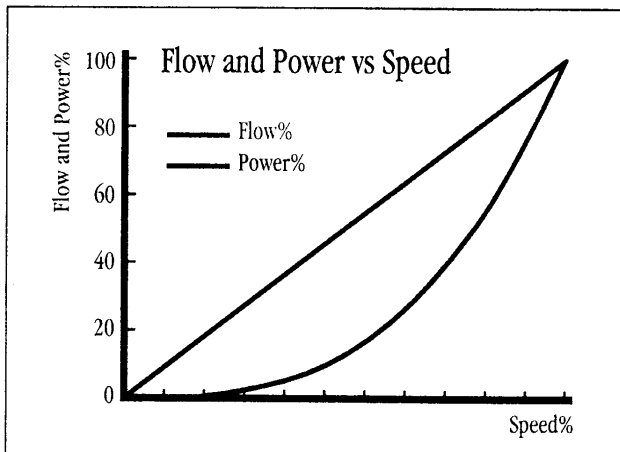

Reduce Energy Usage and Operating Costs

Reducing the speed of a centrifugal pump/fan load drastically reduces power consumption. Both drive models offer you the speed control to accomplish this. In addition, the large reduction in starting current can save utility demand charges.

Improved Efficiency and Reduced Maintenance Costs

Variable speed allows you to better control your process and reduce maintenance costs compared to mechanical and electromechanical devices such as:

- gearboxes
- belts and sheaves
- valves
- outlet dampers
- reversing starters
- reduced voltage starters
- multi-speed starters
- multi-speed motors

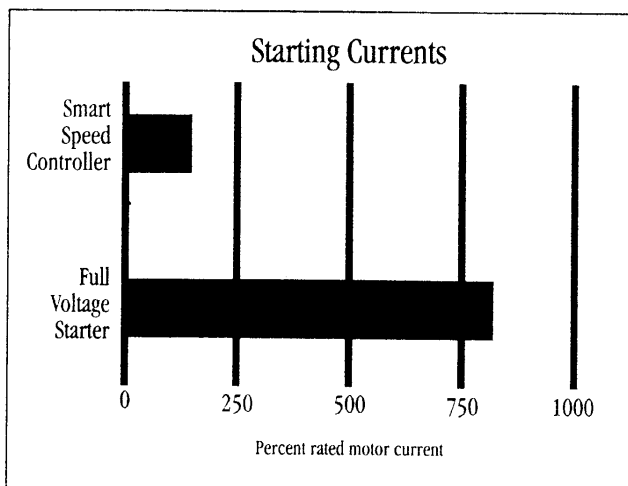
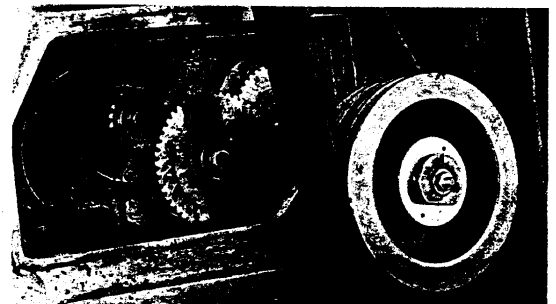
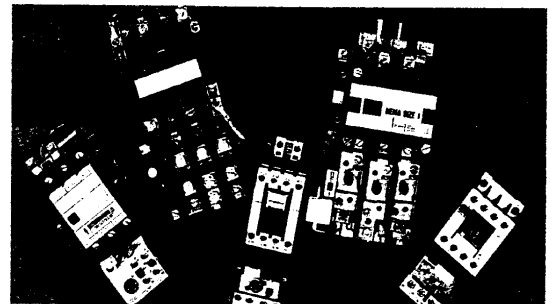

Prolong Equipment and Motor Life

Adjustable acceleration and deceleration times provide inherent soft starting and stopping. This is further enhanced by the drive's programmable "S" Curve adjustment. This means a huge reduction in starting currents and elimination of excessive starting torques.

Application Friendly Design

The many design features of the Bulletin 160 SSC drive provide the application flexibility needed to meet today's changing plant floor environment.

Feature	Benefit
Relay Precharge Circuit NEW	Limits inrush current and simplifies selection of branch circuit protection devices
Electronic Motor Overload Protection	(UL listed and IEC compliant) Saves the extra cost and panel space of installing a separate overload relay
Programmable Control Terminal Block	Helps minimize additional external control logic
6 kV Transient Protection NEW	Provides 6 kV transient protection
24V Sink Logic Interface	Allows 24V "sink logic" inputs from PLC controls
Ground Fault Protection	Ensures ground fault protection in all conditions (start up and run)
Programmable Output Contact	Provides status condition/alarming
Instantaneous Software Current Trip NEW	Provides protection against unexpected changes in load conditions
High Torque	Provides excellent torque performance
High Speed Regulation	Provides tighter speed regulation
High Torque Limit	Designed to eliminate nuisance tripping
Self-Generating EDS Files NEW	Reduces DeviceNet installation costs
Modular Communication Options	Eliminates need for additional panel space
Diagnostic Fault Indication	Aids in troubleshooting
Three Fault Code Buffers NEW	Enhances diagnostics to reduce maintenance costs
Multi-Brake Transistor	Allows connection of simple brake resistors
Programmable Duty Cycle	Meets a wide range of braking applications
Low Inrush Current	Increases productivity/throughput
Emergency Stop Release NEW	Simplifies control logic and increases up time
Automatic Recovery On Power-Up	Provides automatic recovery from fault conditions/line loss
Skid Frequency	Helps eliminate mechanical vibrations

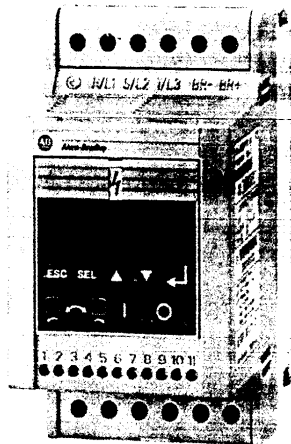

160 SSC™ Variable Speed Drive

The 160 SSC (Smart Speed Controller) is a compact variable speed drive for use on three-phase induction AC motors. It is microprocessor controlled and fully programmable for a variety of applications.

Standard Features Include:

- Ratings of 0.37-4.0 kW (0.5-5 HP)
- Very Compact Design
- Feed Through Wiring
- IGBT Technology
- PWM Control
- Quiet Operation
- Programmable

Standard Drive Configurations:

- IP20 (Open Style)
- Chassis Mount

Configured Drives Available:

- IP66 (NEMA 4/12)
- IP66 (NEMA 4X)

Approvals:

- UL (UL 508C)
- C/UL (CSA 22.2)
- CE^① EMC Directive (EMC: EN61800-3, EN50081-1, EN50082-2)
Low Voltage Directive (LVD: EN50178, EN6024-1)

① External components and proper guidelines must be followed. Refer to the 160 User Manual, Publication 0160-5.15 for details.

TABLE OF CONTENTS

Standard Drives Program

<u>Description</u>	<u>Page</u>
Catalog Number Description	12
Product Selection	12
Operator Interface & Communication Devices	13
Accessories	14
Accessories and Repair Parts – Field Installed	15
Bulletin 160 Block Diagram	17
Branch Circuit Block Diagram	17
Specifications	18
Approximate Dimensions	20
Communication Module Specifications	24
Display Parameter Descriptions	24
Program Parameter Descriptions	25

Configured Drives Program

Ordering Instructions	26
Catalog Number Description	26
Product Selection	26
Factory Installed Enclosure Options	27
Option Rules	27
Custom Configured Drives Program	27
Approximate Dimensions for 160 NEMA Type 4 & 4x Stainless Steel Enclosures	28

Your order must include

- Catalog number of the drive
- If required, catalog number of any accessories and/or factory installed options.

Standard Drives Program

Catalog Number Description

160 – **AA02** **N** **SF1** **P1**

Bulletin Number

Drive Rating
(must be specified)

Enclosure Rating
(must be specified)

Control Model
(must be specified)

Programmer
(optional)

Product Selection



Input Voltage Rating	Drive Ratings			IP 20 (Open Style)	
	kW	HP	Output Current Rating	Analog Signal Follower Model Catalog Number ^{①③}	Preset Speed Model Catalog Number ^{①③}
200-240V 50/60 Hz Single-Phase	0.37	0.5	2.3A	160S - AA02NSF1	160S - AA02NPS1
	0.55	0.75	3.0A	160S - AA03NSF1	160S - AA03NPS1
	0.75	1	4.5A	160S - AA04NSF1	160S - AA04NPS1
	1.5	2	8.0A	160S - AA08NSF1	160S - AA08NPS1
200-240V 50/60 Hz Three-Phase	0.37	0.5	2.3A	160 - AA02NSF1	160 - AA02NPS1
	0.55	0.75	3.0A	160 - AA03NSF1	160 - AA03NPS1
	0.75	1	4.5A	160 - AA04NSF1	160 - AA04NPS1
	1.5	2	8.0A	160 - AA08NSF1	160 - AA08NPS1
	2.2	3	12.0A	160 - AA12NSF1	160 - AA12NPS1
	4.0	5	18.0A	160 - AA18NSF1	160 - AA18NPS1
380-460V 50/60 Hz Three-Phase	0.37	0.5	1.2A	160 - BA01NSF1	160 - BA01NPS1
	0.55	0.75	1.7A	160 - BA02NSF1	160 - BA02NPS1
	0.75	1	2.3A	160 - BA03NSF1	160 - BA03NPS1
	1.5	2	4.0A	160 - BA04NSF1	160 - BA04NPS1
	2.2	3	6.0A	160 - BA06NSF1	160 - BA06NPS1
	4.0	5	10.5A	160 - BA10NSF1	160 - BA10NPS1

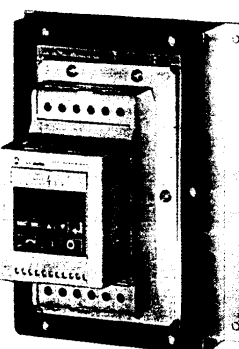

Input Voltage Rating	Drive Ratings			IP 20 (Chassis Mount) ^②	
	kW	HP	Output Current Rating	Analog Signal Follower Model Catalog Number ^{①③}	Preset Speed Model Catalog Number ^{①③}
200-240V 50/60 Hz Single-Phase	0.37	0.5	2.3A	160S - AA02PSF1	160S - AA02PPS1
	0.55	0.75	3.0A	160S - AA03PSF1	160S - AA03PPS1
	0.75	1	4.5A	160S - AA04PSF1	160S - AA04PPS1
	1.5	2	8.0A	160S - AA08PSF1	160S - AA08PPS1
200-240V 50/60 Hz Three-Phase	0.37	0.5	2.3A	160 - AA02PSF1	160 - AA02PPS1
	0.55	0.75	3.0A	160 - AA03PSF1	160 - AA03PPS1
	0.75	1	4.5A	160 - AA04PSF1	160 - AA04PPS1
	1.5	2	8.0A	160 - AA08PSF1	160 - AA08PPS1
	2.2	3	12.0A	160 - AA12PSF1	160 - AA12PPS1
	4.0	5	18.0A	160 - AA18PSF1	160 - AA18PPS1
380-460V 50/60 Hz Three-Phase	0.37	0.5	1.2A	160 - BA01PSF1	160 - BA01PPS1
	0.55	0.75	1.7A	160 - BA02PSF1	160 - BA02PPS1
	0.75	1	2.3A	160 - BA03PSF1	160 - BA03PPS1
	1.5	2	4.0A	160 - BA04PSF1	160 - BA04PPS1
	2.2	3	6.0A	160 - BA06PSF1	160 - BA06PPS1
	4.0	5	10.5A	160 - BA10PSF1	160 - BA10PPS1







① The Bulletin 160 comes standard with a Ready/Fault indication panel. To order a drive with a Program Keypad Module installed, add suffix "P1" to the catalog number. For example: Catalog Number 160-AA02NSF1 becomes 160-AA02NSF1P1

② Meets IP54/65/66 (NEMA 12/4/4X) when installed in suitable enclosure.

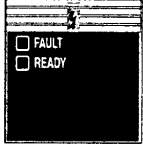
③ For pricing information refer to publication 0160-3.0.

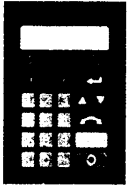
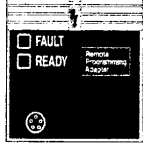
Standard Drives Program

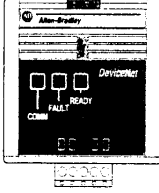
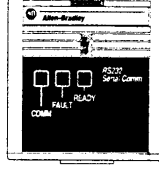



Operator Interface & Communication Devices

Accessory	Description	Catalog Number ^①
	Ready/Fault Indicating Panel - Indicates if the drive is READY for operation or if a FAULT condition has occurred. This module is provided as “standard equipment” when no other factory installed options are ordered.	160-B1
	Program Keypad Module - Provides the ability to program and/or monitor all drive parameters as well as provide local keypad control (start, stop and reverse functions). See page 12, Footnote 1, for information on how to order this option factory installed.	160-P1
	Remote Keypad Module - Provides the ability to mount the operator interface remote from the drive. A Remote Programming Adapter (160-RPA) and cable must be ordered separately.	160-P2
	CopyCat Keypad Module - Provides the ability to program or monitor individual drive parameters or upload and download all drive parameters. A Remote Programming Adapter (160-RPA) and cable must be ordered separately.	160-P3
	Remote Programming Adapter - Provides a simple interface connection for the Remote and CopyCat Keypad Modules.	160-RPA
	Cables - Connects the Remote Programming Adapter to either the Remote or CopyCat Keypad Module. Several different cable lengths and types are available.	See Page 15
	DeviceNet™ Communication Module - Allows control and monitoring of parameters via a DeviceNet network. This module adds 21.4 mm (0.85 in.) to the overall depth of the drive. A 10 pin DeviceNet connector is included. See page 23 for dimensional information.	160-DN2
	RS232 Serial Communication Module - Provides serial communication between the drive and a PC or PLC via DF1 protocol. This module adds 21.4 mm (0.85 in.) to the overall depth of the drive. Equipped with standard 9 pin D-Shell connector. See page 23 for dimensional information.	160-RS1
	DriveExplorer™ Software - Windows® based software package that provides an intuitive means for monitoring or configuring Allen-Bradley drives and communications adapters.	9306-4KS0EFF

^① For pricing information refer to publication 0160-3.0.

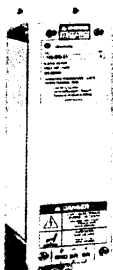
Standard Drives Program

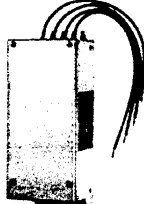
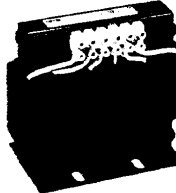
Accessories

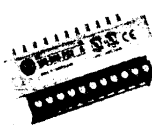
Accessory	Description	Ordering Information	Dimension Information
	<p>Dynamic Brake Module - Provides external dynamic braking capability for applications with a duty cycle rating not exceeding 5%. Parameter 52 (DB Enable) must be set to 5% to achieve this performance level. For applications greater than 5%, a resistor package must be properly sized to avoid overheating.</p>	See Page 15	See Page 21
	<p>Capacitor Module - Provides extended ride through capability and increases inherent braking performance. This module connects to the load side power terminals marked DC- and DC+.</p>	See Page 16	See Page 21
	<p>Line Filter Module - Reduces conductive emissions to meet EMC compliant installations. The line filters are designed so that the drive can be mounted on top (piggyback) of the line filter module to help reduce overall enclosure size.</p>	See Page 16 for Class A (LF) and Class A&B (RF) catalog numbers.	See Page 22
	<p>Line Reactor - Provides input power conditioning when installed on the line side of the drive, or reflected wave protection when installed on the load side of the drive. When used for reflected wave protection, the reactor should be mounted close to the motor. Consult the 160 Drive User Manual, Publication 160-5.15 for recommendations on when to use this device.</p>	See Page 15	See Page 22
	<p>RWR Module - Reduces potentially destructive reflected wave spikes that can occur in applications with long cable distances between the drive and motor. This device is designed for installation close to the output terminals of the drive. Consult the 160 Drive User Manual, publication 160-5.15 for recommendations on when to use this device.</p>	See Page 15	See Publication 1204-5.1
	<p>24V DC Interface Module - Allows use of 24V DC "sink logic" control. Two versions are available, one for preset speed models and one for analog signal follower models. The 24V DC interface attaches directly to the drives' control terminal block.</p>	See Page 15	No added panel space is necessary with this device.

Standard Drives Program



Accessories and Repair Parts – Field Installed

Accessories

Catalog Number	Description [®]
160-DM-SF1 ^①	24V DC Interface (Analog Model)
160-DM-PS1 ^①	24V DC Interface (Preset Model)
160-C05	0.5 m (1.6 ft.) Cable w/ right angle connector
160-C10	1.0 m (3.3 ft.) Cable
160-C30	3.0 m (9.8 ft.) Cable
160-C50	5.0 m (16.4 ft.) Cable

Repair Parts

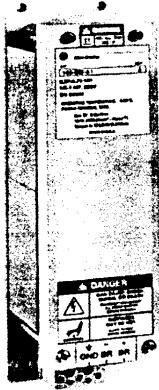
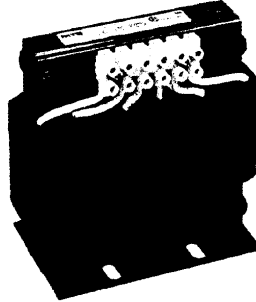
Catalog Number	Description [®]
160-FRK1	Fan Replacement Kit, 0.75-2.2 kW (1-3 HP) for Series A or B drives
160-FRK2	Fan Replacement Kit, 0.75-2.2 kW (1-3 HP) for Series C drives
160-FRK3	Fan Replacement Kit, 4 kW (5 HP) for Series C drives

Drive Ratings			Dynamic Brake Module	Line Reactors - Open Style	RWR Module
					
Input Voltage Rating	kW	HP	Catalog Number [®]	Catalog Number ^{②⑥}	Catalog Number ^{④⑤}
200-240V, 50/60 Hz, Single-Phase	0.37	0.5	—	—	—
	0.55	0.75	—	—	—
	0.75	1	160-BMA1	—	—
	1.5	2	160-BMA2	—	—
200-240V, 50/60 Hz, Three-Phase	0.37	0.5	—	1321-3R4-B	—
	0.55	0.75	—	1321-3R4-A	—
	0.75	1	160-BMA1	1321-3R4-A	—
	1.5	2	160-BMA2	1321-3R8-A	—
	2.2	3	160-BMA2	1321-3R12-A	—
	4.0	5	160-BMA2 ^③	1321-3R18-A	—
380-460V, 50/60 Hz, Three-Phase	0.37	0.5	—	1321-3R2-B	1204-RWR2-09-B
	0.55	0.75	—	1321-3R2-A	1204-RWR2-09-B
	0.75	1	160-BMB1	1321-3R2-A	1204-RWR2-09-B
	1.5	2	160-BMB2	1321-3R4-B	1204-RWR2-09-B
	2.2	3	160-BMB2	1321-3R8-B	1204-RWR2-09-B
	4.0	5	160-BMB2 ^③	1321-3R18-B	1204-RWR2-09-B ^⑤

^① Series B 24V Interface Modules are required for use with Series C Drives.

^② Catalog numbers listed are for 3% impedance open style units. NEMA Type 1 and 5% impedance reactor types are also available, refer to publication 1321-2.0.

^③ TWO UNITS MUST BE USED, wired in parallel.

^④ Refer to Publication 1204-5.1 for dimensional information on RWR Devices.

^⑤ The 1204-RWR2-09-B may be used at a 10.5 Amp current rating providing the cable length from drive to motor is less than 122 meters (400 feet).

^⑥ For pricing information refer to publication 0160-3.0.

Standard Drives Program

Accessories and Repair Parts – Field Installed

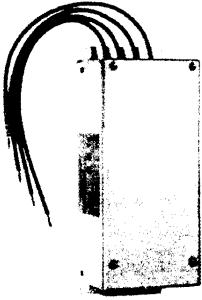
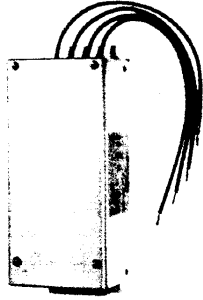
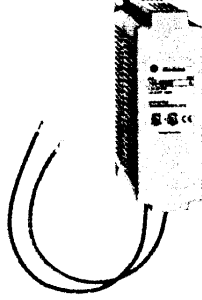
Drive Ratings			"LF" Line Filter Module	"RF" Line Filter Module	Capacitor Module
					
Input Voltage Rating	kW	HP	Catalog Number ①③	Catalog Number ②③	Catalog Number ③
200-240V, 50/60 Hz, Single-Phase	0.37	0.5	160S-LFA1	160S-RFA-6-A	160-CMA1
	0.55	0.75	160S-LFA1	160S-RFA-6-A	160-CMA1
	0.75	1	160S-LFA1	160S-RFA-10-A	160-CMA1
	1.5	2	160S-LFA1④	160S-RFA-16-B	160-CMA1
200-240V, 50/60 Hz, Three-Phase	0.37	0.5	160-LFA2	160-RFB-3-A	160-CMA1
	0.55	0.75	160-LFA2	160-RFB-3-A	160-CMA1
	0.75	1	160-LFA2	160-RFB-9-A	160-CMA1
	1.5	2	160-LFA2	160-RFB-9-A	160-CMA1
	2.2	3	160-LFA2	160-RFB-15-A	160-CMA1
	4.0	5	—	160-RFB-22-B	160-CMA1
380-460V, 50/60 Hz, Three-Phase	0.37	0.5	160-LFB1	160-RFB-3-A	160-CMB1
	0.55	0.75	160-LFB1	160-RFB-3-A	160-CMB1
	0.75	1	160-LFB1	160-RFB-3-A	160-CMB1
	1.5	2	160-LFB1	160-RFB-9-A	160-CMB1
	2.2	3	160-LFB1	160-RFB-9-A	160-CMB1
	4.0	5	—	160-RFB-14-B	160-CMB1

① The 160LF type filters are designed to meet Class A conducted emissions. These units have been tested with a maximum motor cable length of 75 meters (246 feet) for 230V units and 40 meters (131 feet) for 460V units. Refer to the 160 User Manual (publication 0160-5.15) for detailed installation considerations.

② The 160RF type filters are designed to meet Class A and B conducted emissions. These units have been tested with a maximum motor cable length of 25 meters (82 feet) for both 230V and 460V units. Refer to the 160 User Manual (publication 0160-5.15) for more detailed installation considerations.

③ For pricing information refer to publication 0160-3.0.

④ Must mount separately when used with Series C drives.

Standard Drives Program

Bulletin 160 Block Diagram

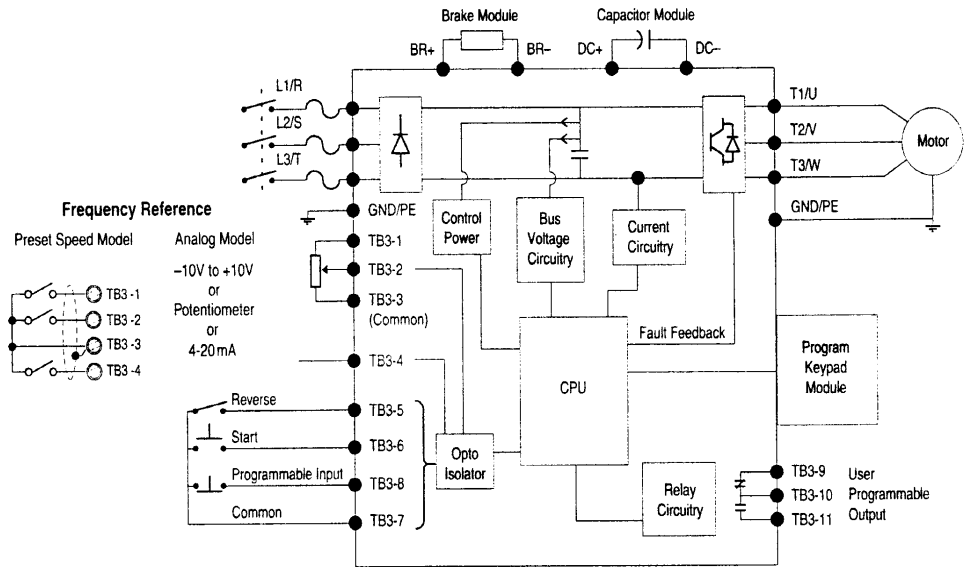

Branch Circuit Block Diagram

Short circuit and overload protection are requirements of any motor branch circuit. Input power conditioning, CE conformance, motor cable length and motor cable type (reflected wave and capacitive current coupling considerations) are important considerations of drive applications.

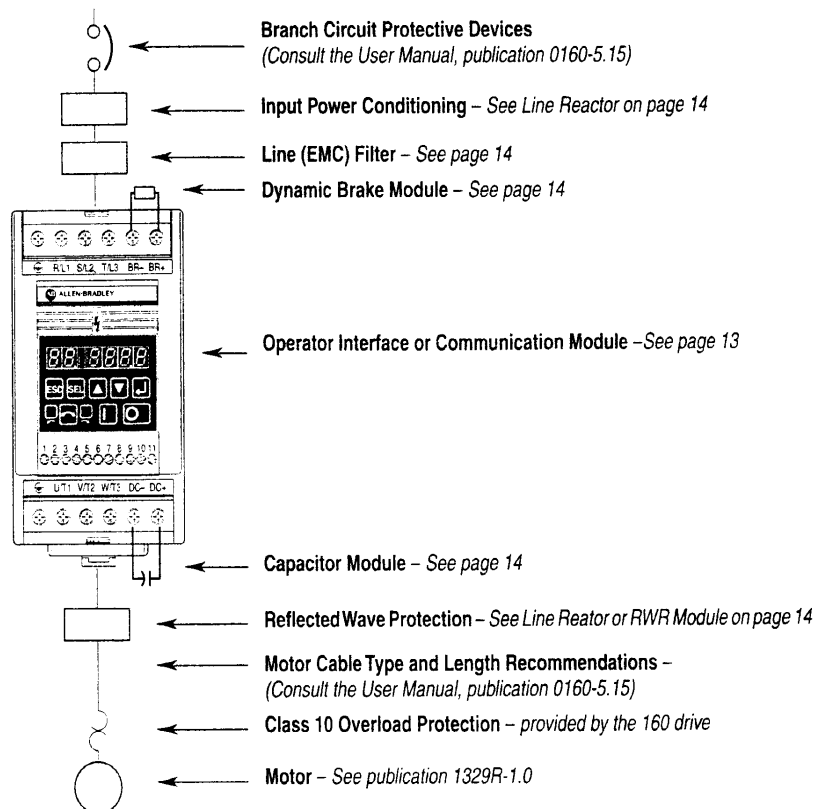

Standard Drives Program

Specifications

Drive Ratings										
IP20 Catalog Number		Output Ratings			Input Ratings		Dynamic Braking Torque		Power Dissipation	
Single-Phase Input, 50/60 Hz	Three-Phase Input, 50/60 Hz	kW	HP	Output Current	Operating Voltage Range	kVA	Without External Resistor	With External Resistor	IP20 (Open Style)	IP 20 (Chassis Mount)
200 - 240V										
160S-AA02	160-AA02	0.37	0.5	2.3A	180-265V	1.4	100%	-	20W	4W
160S-AA03	160-AA03	0.55	0.75	3.0A	180-265V	1.8	100%	-	25W	5W
160S-AA04	160-AA04	0.75	1	4.5A	180-265V	2.7	100%	200%	35W	10W
160S-AA08	160-AA08	1.5	2	8.0A	180-265V	4.0	50%	150%	74W	15W
-	160-AA12	2.2	3	12.0A	180-265V	7.1	50%	115%	107W	20W
-	160-AA18	4.0	5	18.0A	180-265V	10.6	20%	100%	137W	-
380 - 460V										
-	160-BA01	0.37	0.5	1.2A	340-506V	1.4	100%	-	25W	4W
-	160-BA02	0.55	0.75	1.7A	340-506V	2.0	100%	-	30W	5W
-	160-BA03	0.75	1	2.3A	340-506V	2.7	100%	200%	37W	8W
-	160-BA04	1.5	2	4.0A	340-506V	4.7	50%	150%	50W	15W
-	160-BA06	2.2	3	6.0A	340-506V	7.1	50%	115%	77W	20W
-	160-BA10	4.0	5	10.5A	340-506V	12.3	20%	100%	120W	-

Input/Output Ratings (All Drive Ratings)

Output Voltage	Adjustable from 0V to input voltage
Output Frequency	0 to 240 Hz - Programmable
Efficiency	97.5% (Typical)
Transient Protection	Standard 6kV (Series C drives)

Environmental Specifications (All Drive Ratings)

Enclosure	IP 20/IP66 (NEMA Type 12/4/4X)
Ambient Temperature	0 to 50 degrees C (32 to 122 degrees F)
IP 20	0 to 40 degrees C (32 to 104 degrees F)
IP 66 (NEMA Type 12/4/4X)	
Storage Temperature	-40 to 85 degrees C (-40 to 185 degrees F)
Relative Humidity	0 to 95% (non condensing)
Vibration	1.0 G Operational - 2.5 G Non-operational
Shock	15 G Operational - 30 G Non-operational
Altitude	1,000 meters (3,300 feet) without derating

Control Inputs

Control Input Type	For dry contact closure input - drive has an internal 12V power supply that provides 10mA (typical) current. Also accepts open collector/solid-state input with maximum leakage current of 50µA. Optional 24V DC interface allows use of 24V DC "sink logic" inputs.
Start, Stop, Forward/Reverse	Configurable inputs for 2 or 3 wire control

Control Inputs (Analog Signal Follower Model Only)

Analog Input (4 to 20mA)	Input impedance 250 ohms
Analog Input (-10 to +10V DC)	Input impedance 100k ohms
External Speed Potentiometer	1k to 10k ohms, 2 Watt minimum
PI Control	Parameter 46, setting 9 provides PI Control function
SW1, SW2	Parameter 46, setting 8 provides 4 preset speeds and 2 accel/decel times

Standard Drives Program

Specifications, Continued

Control Inputs (Preset Speed Model Only)

SW1, SW2, SW3	Configurable inputs for control of 8 preset speeds and 2 accel/decel times
---------------	--

Control Output

Programmable Output (form C relay contact)	Resistive Rating: 0.4A at 125V AC, 0.2A at 230V AC, 2A at 30V DC Inductive Rating: 0.2A at 125V AC, 0.1A at 230V AC, 1A at 30V DC Programmable for eleven different functions
---	---

Control Features

PWM Algorithm	Sine weighted PWM with harmonic compensation
Switching Device (3-Phase Output)	IGBT (Insulated Gate Bipolar Transistor)
V/Hz Ratio	Programmable
Carrier Frequency	Adjustable from 2 kHz to 8 kHz in 100 Hz increments (factory default is 4 kHz)
DC Boost	Adjustable - Select from a family of boost curves
Current Limiting	Trip free operation, coordinated for drive and motor protection. Programmable from 1% to 180% of drive Output Current.
Motor Protection	I ² t overload protection - 150% for 60 seconds, 200% for 30 seconds (Provides Class 10 overload protection)
Overload Pattern #0	Flat response over speed range (no speed compensation)
Overload Pattern #1	Speed compensation below 25% of base speed
Overload Pattern #2	Speed compensation below 100% of base speed
Acceleration/Deceleration Time(s)	0.1 to 600 seconds
S-Curve Accel/Decel Time(s)	0 to 100% of accel/decel time - not to exceed 60 seconds
Stopping Modes	4 modes (programmable)
Ramp to Stop	0.1 to 600 seconds
Coast	Stops all PWM output
DC Injection Brake	Applies DC voltage to the motor for 0 to 25 seconds
DC Injection Braking w/ Auto Stop	Applies DC voltage to the motor for 0 to 25 seconds with Auto Shutoff

Protective Features

Overcurrent	200% hardware limit, 300% instantaneous fault
Excessive Temperature	Embedded temperature sensor trips if heatsink temperature exceeds 95 degrees C (203 degrees F)
Over Voltage Drive Rated Input = 200-240V AC Drive Rated Input = 380-460V AC	DC Bus voltage is monitored for safe operation Overvoltage trip occurs at 400V DC bus voltage (equivalent to 290V AC incoming line voltage). Overvoltage trip occurs at 800V DC bus voltage (equivalent to 575V AC incoming line voltage).
Under Voltage Drive Rated Input = 200-240V AC Drive Rated Input = 380-460V AC	DC Bus voltage is monitored for safe operation Undervoltage trip occurs at 210V DC bus voltage (equivalent to 150V AC incoming line voltage). Undervoltage trip occurs at 390V DC bus voltage (equivalent to 275V AC incoming line voltage).
Control Ride Through	Minimum ride through is 0.5 seconds - typical value 2 seconds
Ground Fault	Protection in both Start and Run Mode
Faultless Ride Through	100 milliseconds
Output Short Circuit	Any output phase to phase short

Programming

Programmer / Display Type	Program Keypad Module - 6 character LED display Remote Keypad Module - 4 character LED display CopyCat Keypad Module - 2 line, 16 character LCD display
Local Controls	SPEED, RUN, STOP, and DIRECTION controls

Standard Drives Program

Analog Signal Follower and Preset Speed Models - Approximate Dimensions

Dimensions are shown in millimeters (inches). Dimensions are not to be used for manufacturing purposes.

0.37 kW-2.2 kW (0.5-3 HP), Three-Phase, 200-240V AC & 380-460V AC
 0.37 kW-0.75 kW (0.5-1 HP), Single-Phase, 200-240V AC

Approximate Weight is 0.94 kg (2.07 lbs.)

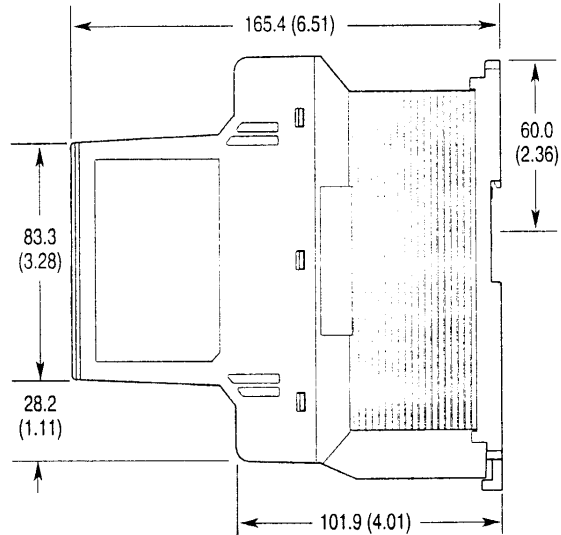
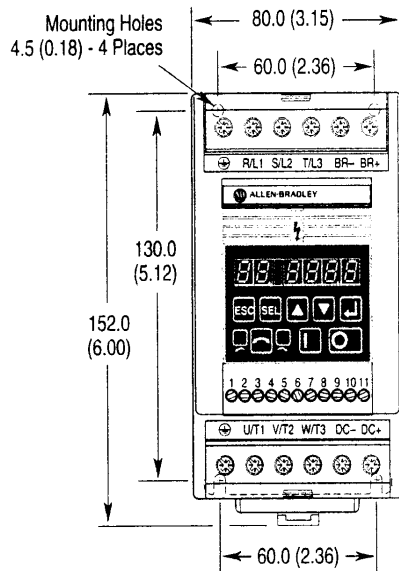

4.0 kW (5 HP), Three-Phase, 200-240V AC & 380-460V AC
 1.5 kW (2 HP), Single-Phase, 200-240V AC

Approximate Weight is 2.37 kg (5.23 lbs.)

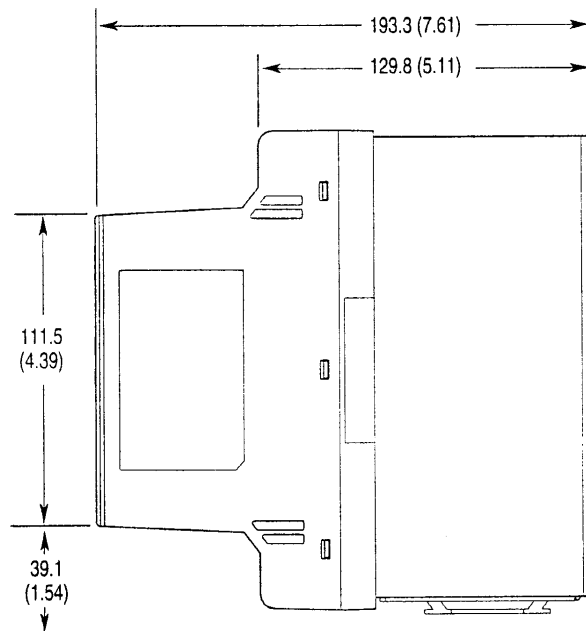
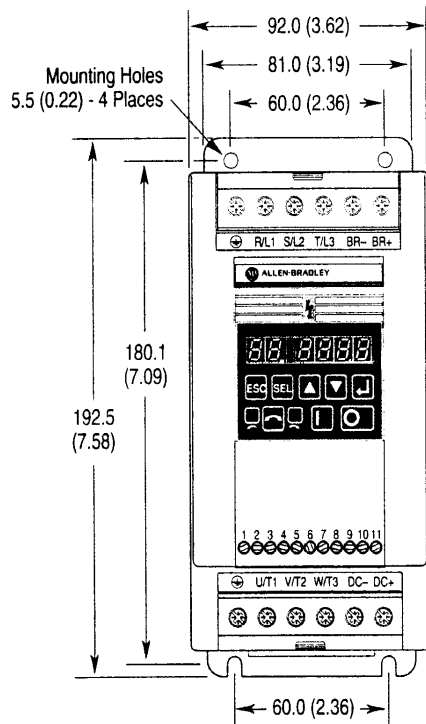

* **NOTE:** 12.7 mm (0.50 in.) is required around the top, bottom and front of all drives. No clearance is required between drives with the exception of the 2.2 kW (3 HP) rating which requires 8.4 mm (0.33 in.).

Standard Drives Program

Approximate Dimensions, Continued

Dimensions are shown in millimeters (inches). Dimensions are not to be used for manufacturing purposes.

Chassis Mount, All Ratings

Approximate Weight is 7.26 kg (16 lbs.) through 1.5 kW (2 HP) and 7.71 kg (17 lbs.) for 2.2 kW (3 HP)

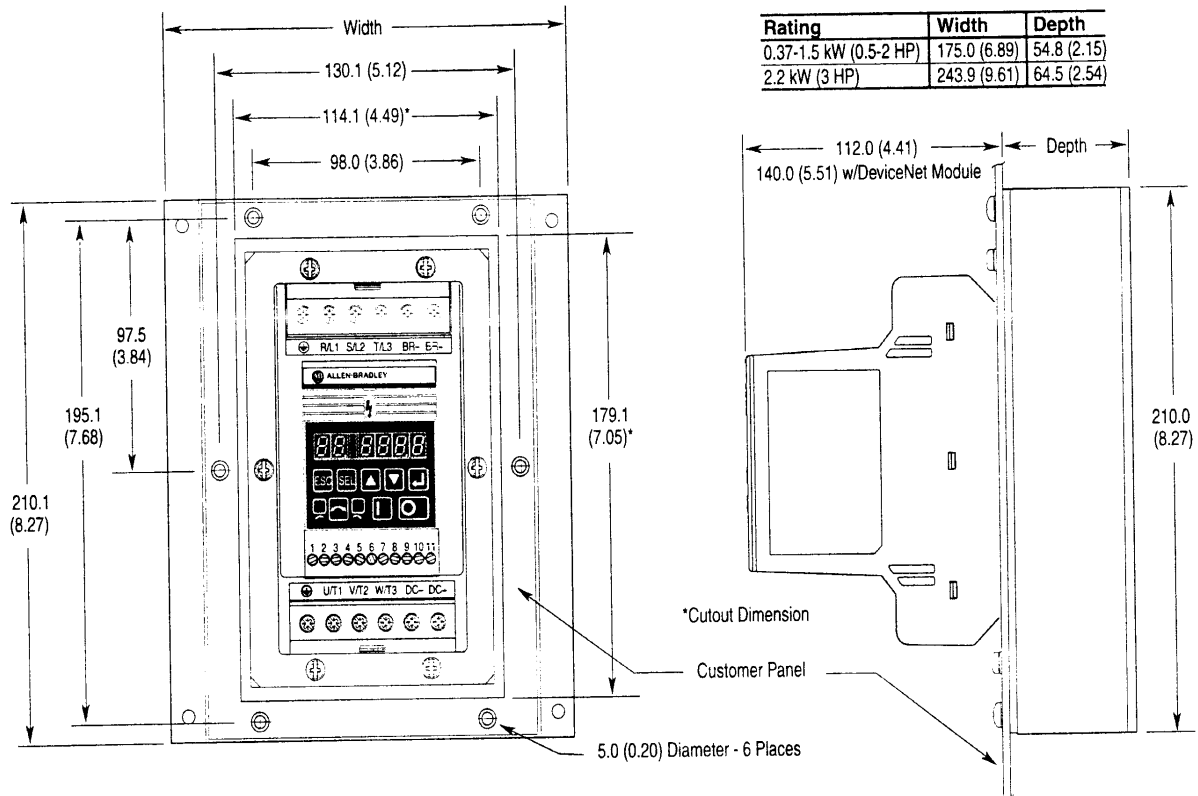

Dynamic Brake Module

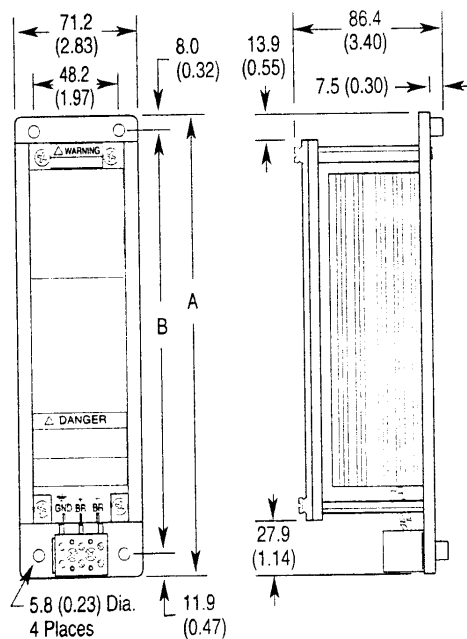

Catalog Number	A	B
160-BMA1, -BMB1	245.0 (9.64)	225.0 (8.86)
160-BMA2, -BMB2	334.0 (13.15)	314.0 (12.36)

Capacitor Module

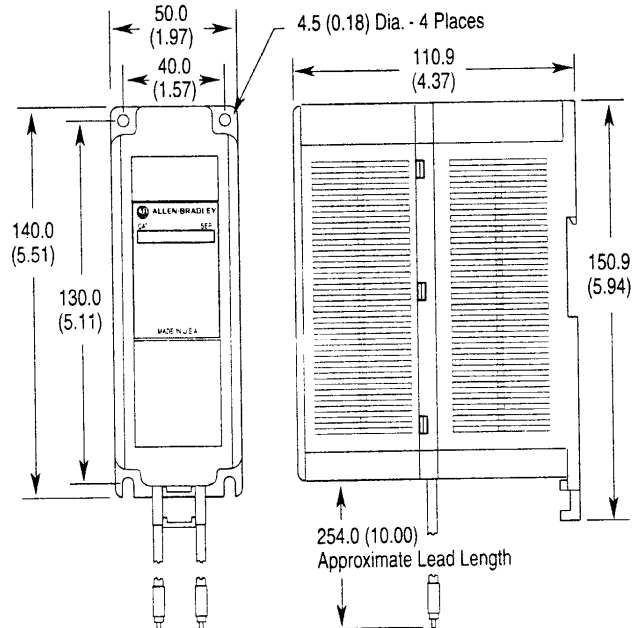

Standard Drives Program

Approximate Dimensions, Continued

Dimensions are shown in millimeters (inches). Dimensions are not to be used for manufacturing purposes.

Line Reactor

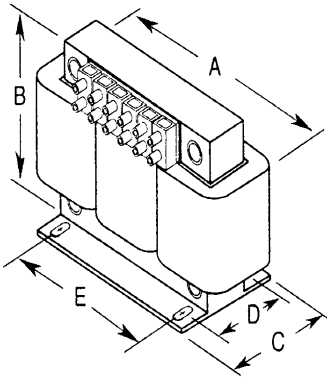

Catalog Number	A	B	C	D	E
1321-3R2-A	112 (4.40)	104 (4.10)	74 (2.90)	50 (1.98)	37 (1.44)
1321-3R2-B	112 (4.40)	104 (4.10)	74 (2.90)	50 (1.98)	37 (1.44)
1321-3R4-A	112 (4.40)	104 (4.10)	76 (3.00)	50 (1.98)	37 (1.44)
1321-3R4-B	112 (4.40)	104 (4.10)	76 (3.00)	50 (1.98)	37 (1.44)
1321-3R8-A	152 (6.00)	127 (5.00)	76 (3.00)	53 (2.10)	51 (2.00)
1321-3R8-B	152 (6.00)	127 (5.00)	76 (3.00)	53 (2.10)	51 (2.00)
1321-3R12-A	152 (6.00)	127 (5.00)	76 (3.00)	53 (2.10)	51 (2.00)
1321-3R18-A	152 (6.00)	133 (5.25)	79 (3.10)	51 (2.00)	51 (2.00)
1321-3R18-B	152 (6.00)	133 (5.25)	86 (3.40)	63 (2.48)	51 (2.00)

Line Filter Module

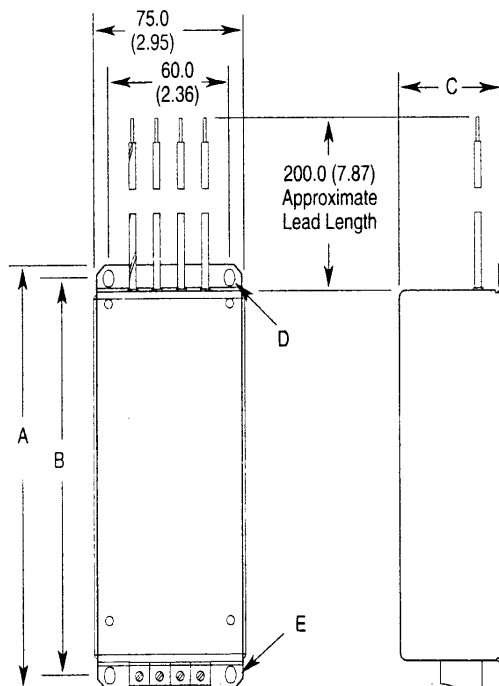

Catalog Number	A	B	C	D	E
160S-RFA-6-A	182.0 (7.17)	167.0 (6.57)	30.0 (1.18)	6.5 x 4.5 (0.26 x 0.18) 2 Places	4.2 (0.17) Diameter 2 Places
160S-RFA-10-A					
160S-RFA-16-B					
160S-RFB-3-A	182.0 (7.17)	167.0 (6.57)	35.0 (1.38)		
160S-RFB-9-A	182.0 (7.17)	167.0 (6.57)	47.5 (1.87)		
160S-LF (All)	174.0 (6.85)	163.0 (6.42)	50.0 (1.97)	7.0 x 5.3 (0.28 x 0.21)	6.9 x 5.3 (0.27 x 0.21)
160-LF (All)					

Three-Phase filter shown (single-phase filter is the same size)

Standard Drives Program

Approximate Dimensions, Continued

Dimensions are shown in millimeters (inches). Dimensions are not to be used for manufacturing purposes.

DeviceNet and RS-232 Module

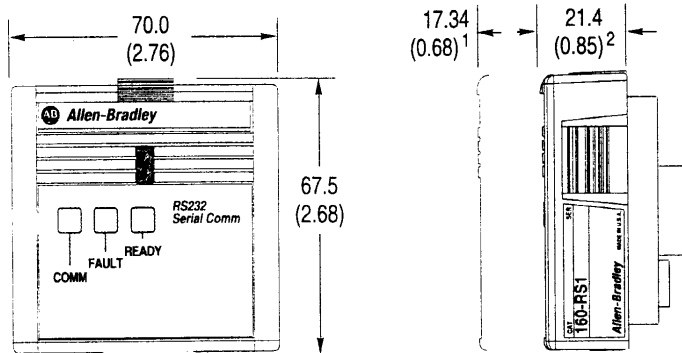

- 1 Required for module removal.
- 2 Module adds this dimension to the overall drive depth.

Remote Keypad Module

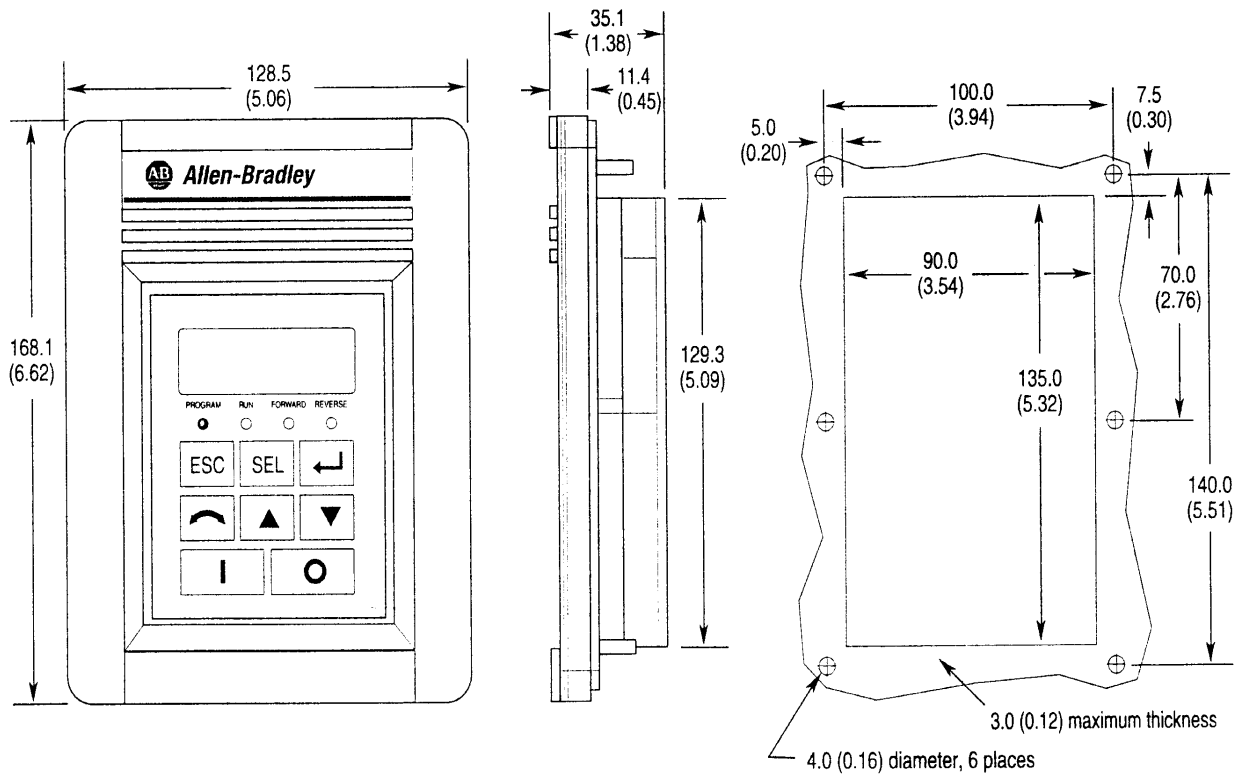

Standard Drives Program

Communication Module Specifications

Specification		DeviceNet (160-DN2)	RS232 (160-RS1)
Electrical	Supply Voltage	Network Supply Voltage 11-25V DC	Supplied by drive
	Power Consumption	1 Watt	1.25 Watts Maximum
	Network Input Current	40 mA Maximum	NA
Communications	Baud Rates	125, 250, 500 KBPS	1200, 2400, 4800, 9600 BPS
	Checksum	NA	BCC or CRC
	Protocol	DeviceNet	DF1 Point to Point, DF1 Multidrop
	Explicit Peer-to-Peer Messaging	No	NA
	I/O Peer-to-Peer Messaging	No	NA
	Configuration Consistency Value	Yes	NA
	Faulted Node Recovery	Yes	NA
	Master/Scanner	No	NA
	I/O Slave Messaging	Yes	NA
Environmental	Ambient Operating Temperature	0 to 50 degrees C (32 to 122 degrees F)	0 to 50 degrees C (32 to 122 degrees F)
	Ambient Storage Temperature	-40 to 85 degrees C (-40 to 185 degrees F)	-40 to 85 degrees C (-40 to 185 degrees F)
	Relative Humidity	0 to 95% non-condensing	0 to 95% non-condensing
	Vibration	1.0 G Operational, 2.5 G Non-Operational	1.0 G Operational, 2.5 G Non-Operational
	Shock	15.0 G Operational, 30.0 G Non-Operational	15.0 G Operational, 30.0 G Non-Operational
	Vibration	1,000 meters (3,300 feet) without derating	1,000 meters (3,300 feet) without derating

Display Parameter Descriptions

Parameter Number	Parameter Name	Description	Units
1	Output Frequency	0.0 to 240.0 Hz	0.1 Hz
2	Output Voltage	0 to max voltage	1 Volt
3	Output Current	0 to 2 times drive rated output current in units of 0.01A	0.01 Amps
4	Output Power	0 to 2 times drive rated output power in units of 0.01kW	0.01 kW
5	Bus Voltage	0V to 410V for 230V controllers, 0V to 815V for 460V controllers	1 Volt
6	Frequency Command	0.0 to 240.0 Hz	0.1 Hz
7	Last Fault	Retains faults for troubleshooting	Numeric Value
8	Heatsink Temperature	0 to 150 degrees C (32 to 302 degrees F)	1 Degree C
9	Controller Status	Running, forward, accelerating, decelerating	Binary Number
10	Controller Type	Used by Rockwell Automation field service personnel	Numeric Value
11	Control Version	Displays firmware version	Numeric Value
12	Input Status	Displays the status of start, stop, and reverse discrete inputs	Binary Number
13	Power Factor Angle	0.0 to 90.0 degrees	0.1 Degrees
14	Memory Probe Display	Used by Rockwell Automation field service personnel	Numeric Value
15	Preset Status	Displays the status of preset speed discrete inputs	Binary Number
16	Analog Input	Displays the analog input as a percent of full scale	0.1%
17	Fault Buffer 0	Stores the last fault that occurred	Numeric Value
18	Fault Buffer 1	Stores the second most recent fault that occurred	Numeric Value
19	Fault Buffer 2	Stores the third most recent fault that occurred	Numeric Value

Standard Drives Program

Program Parameter Descriptions

Parameter Number	Parameter Name	Description	Factory Default
30	Accel Time 1	0.0 to 600.0 seconds	10.0
31	Decel Time 1	0.0 to 600.0 seconds	10.0
32	Minimum Frequency	0 to 240 Hz	0
33	Maximum Frequency	0 to 240 Hz	60
34	Stop Mode Select	Four settings - Ramp, Coast, DC injection braking, DC Injection w/ auto shut off	Ramp
35	Base Frequency	10 to 240 Hz	60
36	Base Voltage	20 to 230V for 230V drives, 20 to 460V for 460V drives	230/460
37	Maximum Voltage	20 to 255V for 230V drives, 20 to 510V for 460V drives	230/460
38	Boost Select	8 boost settings, 4 fan/pump curves	2
39	Skip Frequency	0 to 240 Hz	240
40	Skip Frequency Band	0 to 30 Hz	0
41	Motor Overload Select	Three settings - No derating, Min derating, Max derating	No derating
42	Motor Overload Current	25 to 200% of drive rated current in units of 0.01 amps	115
43	Current Limit	1 to 180% of drive rated current	150
44	DC Hold Time	0 to 25 seconds	0.0
45	DC Hold Voltage	0 to 115V	0
46	Input Mode	Configurable terminal block provides 10 different control schemes	Three-wire
47	Output Configure	11 different settings for a variety of drive status conditions	0
48	Output Threshold	0 to 815	0
49	PWM Frequency	2.0 to 8.0 kHz	4.0
50	Restart Tries	0 to 9	0
51	Restart Time	0.5 to 300.0 seconds	10.0
52	DB Enable	Used to set percent duty cycle for external dynamic braking	Disable
53	S-Curve	0 to 100% accel/decel smoothing	0
54	Clear Fault	Resets faults	0
55	Memory Probe Address	Used by Rockwell Automation personnel	0
56	Reset Functions	Used to reset drive to factory default settings or update input mode	0
57	Program Lock	Protects user settings	0
58	Internal Frequency	0.0 to 240.0 Hz	60
59	Frequency Select	Selects source of frequency (internal or external)	External
60	Zero Offset	Used to add or subtract any system offset to analog input	0
61	Preset Frequency 0	0.0 to 240.0 Hz	3
62	Preset Frequency 1	0.0 to 240.0 Hz	20
63	Preset Frequency 2	0.0 to 240.0 Hz	30
64	Preset Frequency 3	0.0 to 240.0 Hz	40
65	Preset Frequency 4	0.0 to 240.0 Hz	45
66	Preset Frequency 5	0.0 to 240.0 Hz	50
67	Preset Frequency 6	0.0 to 240.0 Hz	55
68	Preset Frequency 7	0.0 to 240.0 Hz	60
69	Accel Time 2	0.0 to 600.0 seconds	20
70	Decel Time 2	0.0 to 600.0 seconds	20
71	IR Compensation	0 to 150%	50
72	Slip Compensation	0.0 to 5.0 Hz	2
73	Reverse Disable	Disables Reverse Input	0
74	Analog Select	Used to select between unipolar and bipolar inputs	0
75	Analog Input Minimum	Sets the percent of analog input to represent Minimum Frequency	0
76	Analog Input Maximum	Sets the percent of analog input to represent Maximum Frequency	100
78	Compensation	Compensates for Motor Instability or Resonance	0
79	Software Current Trip	Software instantaneous current trip	0
80	Stall Fault Time	Selects amount of time the drive is in a stall condition prior to a fault occurring	0
81	PI Proportional Gain	Proportional Response of PI Regulator	0.01
82	PI Integral Gain	Integral Gain of PI Regulator	0.01
83	PI Process Reference	PI will regulate to this setpoint value	0
84	PI Dead Band	PI will ignore errors less than this value	0

Configured Drives Program

Configured Drives Program

The Configured Drives Program allows users to create drive packages based on their specific needs. A complete drive package may be specified by assembling a single catalog number string that includes a base drive, enclosure and all required options.

Ordering Instructions:

1. Select basic Catalog Number from **Table A** based on application requirements (i.e. Voltage, Horsepower, Control Model and Enclosure Ratings).

For example: a 200-240V AC, three-phase, 0.37 kW (0.5 HP), analog signal follower model and a IP66 (NEMA Type 4/12) enclosure. The catalog number is: **160-AA02SF1-AF**.

2. Select Enclosure Options from **Table B** and follow the Option Rules in **Table C**. For example: the catalog number with a fused disconnect switch and Start-Stop pushbuttons is: **160-AA02SF1-AF-DS-D17**.

Catalog Number Description

160 – AA02SF1 – AF – DS-D17

Bulletin Number

Drive Rating and Control Model Type
(must be specified)

Enclosure Rating
(must be specified)

Options
(specify as needed)

Product Selection

Table A

Input Voltage Rating	Drive Ratings			Catalog Number			
	kW	HP	Output Current Rating	IP66 (NEMA 4/12)		IP66 (NEMA 4X - Stainless Steel)	
				Analog Signal Follower Model	Preset Speed Model	Analog Signal Follower Model	Preset Speed Model
200-240V 50/60 Hz Single-Phase	0.37	0.5	2.3A	160S - AA02SF1-AF	160S - AA02PS1-AF	160S-AA02SF1-AS	160S - AA02PS1-AS
	0.55	0.75	3.0A	160S - AA03SF1-AF	160S - AA03PS1-AF	160S-AA03SF1-AS	160S - AA03PS1-AS
	0.75	1	4.5A	160S - AA04SF1-AF	160S - AA04PS1-AF	160S-AA04SF1-AS	160S - AA04PS1-AS
200-240V 50/60 Hz Three-Phase	0.37	0.5	2.3A	160 - AA02SF1-AF	160 - AA02PS1-AF	160-AA02SF1-AS	160 - AA02PS1-AS
	0.55	0.75	3.0A	160 - AA03SF1-AF	160 - AA03PS1-AF	160-AA03SF1-AS	160 - AA03PS1-AS
	0.75	1	4.5A	160 - AA04SF1-AF	160 - AA04PS1-AF	160-AA04SF1-AS	160 - AA04PS1-AS
	1.5	2	8.0A	160 - AA08SF1-AF	160 - AA08PS1-AF	160-AA08SF1-AS	160 - AA08PS1-AS
	2.20	3	12.0A	160 - AA12SF1-AF	160 - AA12PS1-AF	160-AA12SF1-AS	160 - AA12PS1-AF
380-460V 50/60 Hz Three-Phase	0.37	0.5	1.2A	160 - BA01SF1-AF	160 - BA01PS1-AF	160-BA01SF1-AS	160 - BA01PS1-AS
	0.55	0.75	1.7A	160 - BA02SF1-AF	160 - BA02PS1-AF	160-BA02SF1-AS	160 - BA02PS1-AS
	0.75	1	2.3A	160 - BA03SF1-AF	160 - BA03PS1-AF	160-BA03SF1-AS	160 - BA03PS1-AS
	1.5	2	4.0A	160 - BA04SF1-AF	160 - BA04PS1-AF	160-BA04SF1-AS	160 - BA04PS1-AS
	2.2	3	6.0A	160 - BA06SF1-AF	160 - BA06PS1-AF	160-BA06SF1-AS	160 - BA06PS1-AS

① Consult factory for derating guidelines for applications above 37 degrees C (98.6 degrees F).

Important: The Configured Drives Program shown on this page is typical of North America. Other locations should contact their local Rockwell Automation office for availability of similar products.

Configured Drives Program

Factory Installed Enclosure Options

Table B

Description	Option Code ^⑤	Cannot be used with
Operator Interface		
DeviceNet Module ^①	- DN2C	P1C, RS1C, Ready/Fault
Serial Communication Module	- RS1C	DN2C, PIC, Ready/Fault
Ready/Fault Panel	- ③	DN2C, P1C, RS1C
Program Keypad Module (Drive Mounted)	- P1C	DN2C, RS1C, Ready/Fault
Fused Disconnect Switch (Class J Fuses)	- DS	
Cover Mounted Devices:		
"Hand-Off-Auto" Selector Switch	- D13	- D17, D33
"Start-Stop" Push Buttons	- D17	- D13, D33
"Forward/Reverse" Selector Switch	- D32	
"Auto/Manual" Selector Switch	- D33	- D13, D17
White "Drive Run" Pilot Light ^②	- D35	- D36
Red "Drive Fault" Pilot Light ^②	- D36	- D35
"Speed" Potentiometer	- D61	
Control Interface Cards:		
24V DC Interface Card for Analog Drive ^④	- DMSF1C	DMPS1C, LTN120, All Preset Speed Drives
24V DC Interface Card for Preset Speed Drive ^④	- DMPS1C	DMFS1C, LTN120, All Analog Drives
24V DC Interface Module for Analog and Preset Speed Drives ^④	- LTN120	DMPS1C, DMSF1C

① Includes 10 point DeviceNet Connector.

② 120V AC Separate Control Power Required.

③ If a (-P1C), (-DN2C) or (RS1C) is not specified, the drive is supplied with a factory installed "Ready/Fault" indicating panel as standard.

④ Refer to Passport for lead time.

⑤ For pricing information refer to publication 0160-3.0.

Option Rules

Table C

Option	Description
Mutually Exclusive Options	Operator Interface: Program Keypad Module (P1C), DeviceNet Module (DN2C) and (RS1C). Options: Run Pilot Light (D35) and Fault Pilot Light (D36). Start-Stop (D17), Hand-Off-Auto (D13) and Local-Remote (D33). Control Interface Cards: 24V DC for Analog (DMSF1C), 24V DC for Preset (DMPS1C) and 115V DC for Both (LTN120).
Maximum Number of Cover Devices	0.37-1.5 kW (0.5-2 HP) without a disconnect is 4. 2.2 kW (3 HP) without a disconnect and all drives with a disconnect is 5. i.e. Start-Stop (D17) = 2 Cover Devices Forward-Reverse (D32) = 1 Cover Device White Run Pilot Light (D35) = 1 Cover Device = 4 Total
Factory Installed Enclosure Option Catalog Configuration	When ordering, build the catalog string in the following manner: Bulletin number, drive rating, control model, enclosure type and options. Note: Options are to be configured in alpha-numeric sequence.

Custom Configured Drives Program

Drive packages that cannot be ordered via a catalog number can be customized to meet customer requirements for specific options such as special enclosure sizes and colors, terminal blocks and wire type.

Configured Drives Program

Approximate Dimensions for 160 NEMA Type 4 & 4x Stainless Steel Enclosures

0.37 kW-0.75 kW (0.5-1 HP), Single-Phase, 200-240V AC (without disconnect)
 0.37 kW-1.5 kW (0.5-2 HP), Three-Phase, 200-240V AC and 380-460V AC (without disconnect)

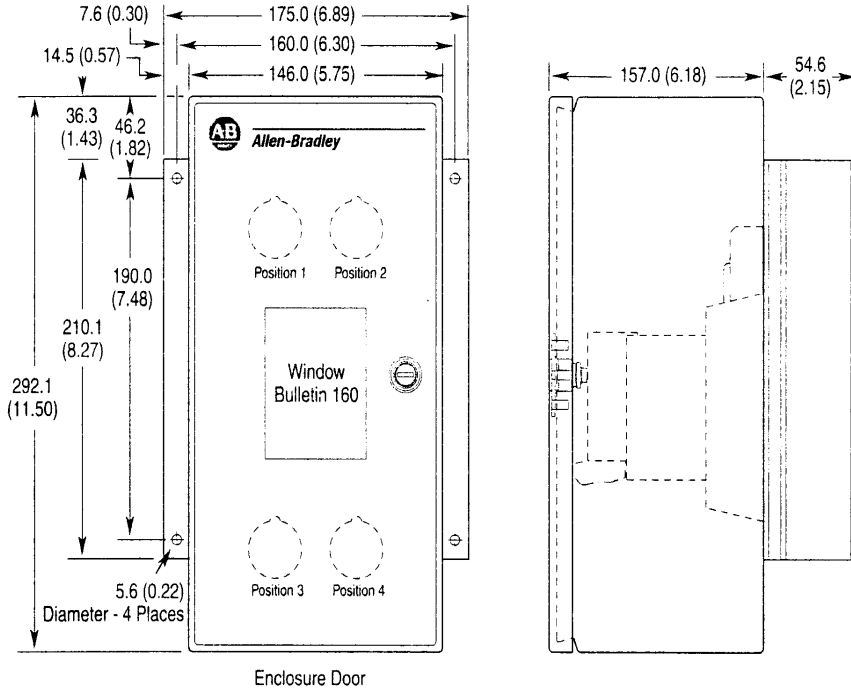

0.37 kW - 0.75 kW (0.5 - 1 HP), Single-Phase 200-240V AC (with disconnect)
 0.37 kW - 1.5 kW (0.5 - 2 HP), Three-Phase 200-240V AC and 380-460V AC (with disconnect)

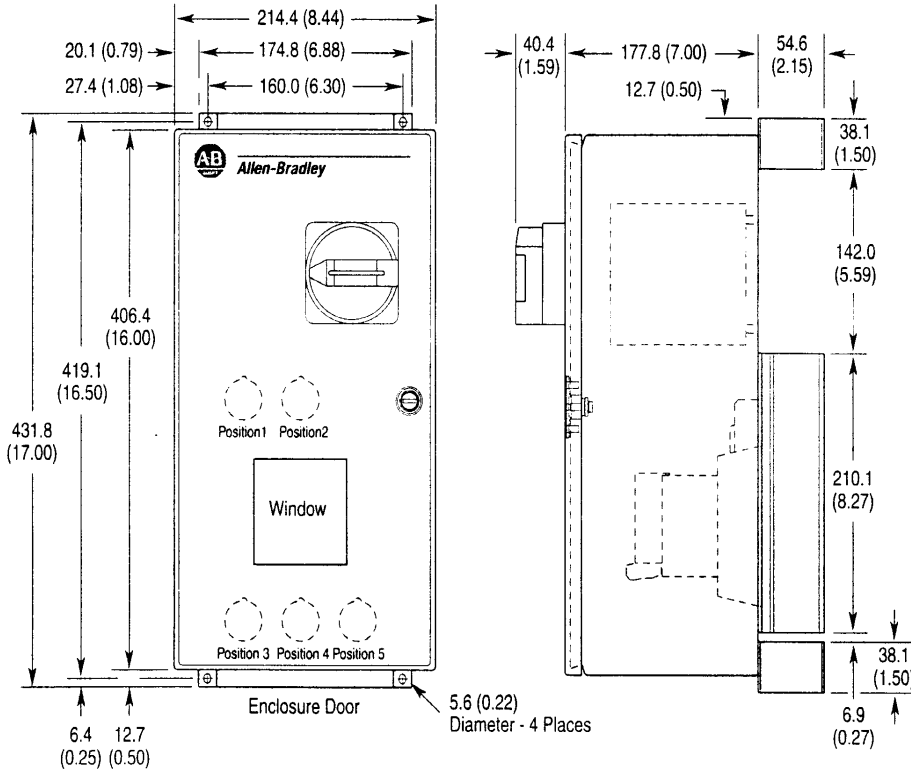

Configured Drives Program

Approximate Dimensions, Continued

Dimensions are shown in millimeters (inches). Dimensions are not to be used for manufacturing purposes.

2.2 kW (3 HP), Three-Phase, 200-240V AC and 380-460VAC (with and without disconnect)

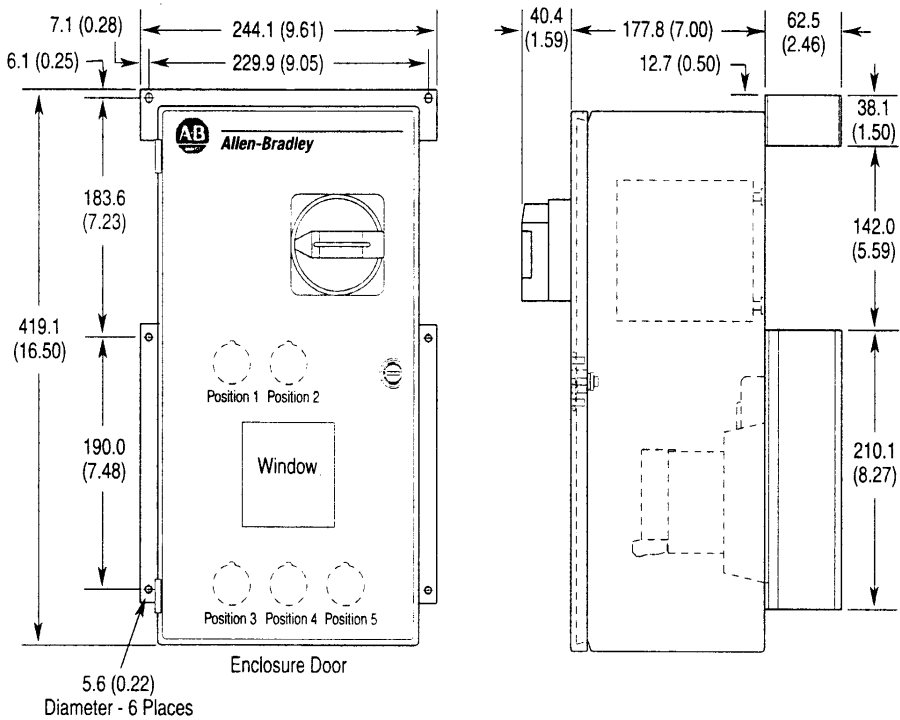

The Automation Investment Cycle™

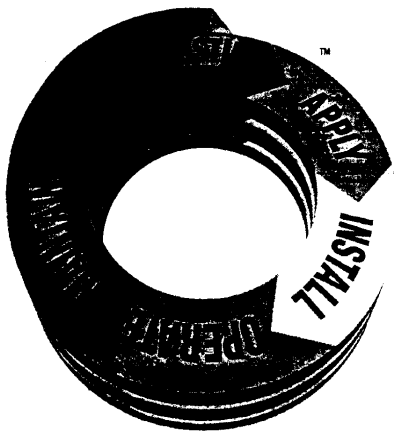

Today's manufacturers must build greater flexibility into their automation systems to meet ever-changing customer demands for more product in less time at reduced prices. This era of flexibility and cost is changing what used to be viewed as one-time automation purchases to long-term productivity benefits.

Allen-Bradley calls this the Automation Investment Life Cycle. Beyond the initial purchase price, Allen-Bradley is helping manufacturers and processors understand and reduce costs associated with justifying, applying, installing, operating, maintaining and upgrading their automation system.

The Bulletin 160 SSC was designed to add value and reduce costs in all stages of the cycle.

Justify

Initial planning and justification by Allen-Bradley engineers and distributors establishes the foundation for a long-term automation investment strategy and identifies motor control requirements.

Apply

Application and sales engineers work with you to identify the right drive for each motor. Strong commonality across the Allen-Bradley drives family simplifies the application stage for even the most complex motor control requirements.

Install

Taking advantage of the wide variety of Allen-Bradley drive packaging options to ease installation, an experienced engineering team assists you with all aspects of system start up.

Operate

Thoughtful planning and installation translate to simple and cost-effective operation. Sophisticated programming tools and the proven reliability of Allen-Bradley drives allow for dependable, unsupervised operation that will help you meet productivity and performance goals.

Maintain

Complete parts repair service and inventory management from Allen-Bradley Global Technical Services, coupled with the built-in troubleshooting capabilities of Allen-Bradley drives, simplify maintenance and enhance productivity.

Improve

The built-in expandability and flexibility of Allen-Bradley drives protects your automation investment by allowing you to take advantage of design improvements and technological innovations.

The Automation Investment Life Cycle, The Automation Investment Life Cycle Symbol, DriveExplorer, SSC are trademarks of Rockwell Automation.

DeviceNet is a trademark of the Open DeviceNet Vendor Association.

Windows is a registered trademark of Microsoft Corporation.

Meeting Global Expectations

The Global Marketplace Demands a Lot from a Product.

Complying with global standards is one of many ways that the Bulletin 160 SSC meets these demands.

At Rockwell Automation, we accomplish this by subjecting the Bulletin 160 SSC design to extensive qualification tests and also by following extremely thorough manufacturing and production test procedures. Our quality system meets the exacting requirements of ISO 9001 and is accredited by DNV. Each drive is individually tested to the degree of quality and reliability demanded by the global marketplace.

