

Features

- Epitaxial Planar Die Construction
- Lead Free By Design/RoHS Compliant (Note 1)
- "Green" Device (Note 2)

Mechanical Data

- Case: SOT-363
- Case Material: Molded Plastic, "Green" Molding Compound. UL Flammability Classification Rating 94V-0
- Moisture Sensitivity: Level 1 per J-STD-020C
- Terminal Connections: See Fig. 2
- Terminals: Finish Matte Tin Finish annealed over Alloy 42 leadframe. Solderable per MIL-STD-202, Method 208
- Marking & Type Code Information: See Page 7
- Ordering Information: See Page 7
- Weight: 0.016 grams (approximate)

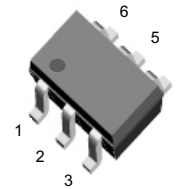

Fig. 1: SOT-363

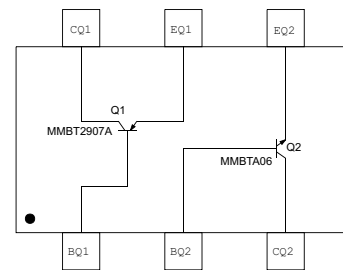

Fig. 2: Schematic & Pin Configuration

Sub-Component P/N	Reference	Device Type	Figure
MMBT2907A_DIE	Q1	PNP Transistor	2
MMBTA06_DIE	Q2	NPN Transistor	2

Maximum Ratings: Total Device @ T_A = 25 C unless otherwise specified

Characteristic	Symbol	Value	Unit
Power Dissipation (Note 3)	P _d	200	mW
Thermal Resistance, Junction to Ambient Air (Note 3)	R _{JA}	625	°C/W
Operating and Storage Junction Temperature Range	V _{EBO}	-55 to +150	°C

Maximum Ratings: Sub-Component Devices @ T_A = 25 C unless otherwise specified

Characteristic	Symbol	Q1-PNP Transistor (MMBT2907A)	Q2-NPN Transistor (MMBTA06)	Unit
Collector-Base Voltage	V _{CBO}	-60	80	V
Collector-Emitter Voltage	V _{CEO}	-60	65	V
Emitter-Base Voltage	V _{EBO}	-5.5	6	V
Collector Current - Continuous (Note 3)	I _C	-600	500	mA

- Notes:
1. No purposefully added lead.
 2. Diodes Inc.'s "Green" policy can be found on our website at http://www.diodes.com/products/lead_free/index.php.
 3. Device mounted on FR-4 PCB, 1 inch x 0.85 inch x 0.062 inch; pad layout as shown on page 8 or on Diodes Inc. suggested pad layout document AP02001, which can be found on our website at <http://www.diodes.com/datasheets/ap02001.pdf>.

Electrical Characteristics @ T_A = 25 C unless otherwise specified
PNP (MMBT2907A) Transistor (Q1):

Characteristic	Symbol	Min	Max	Unit	Test Condition
OFF CHARACTERISTICS (Note 4)					
Collector-Base Breakdown Voltage	V _{(BR)CBO}	-60		V	I _C = -10 A, I _E = 0
Collector-Emitter Breakdown Voltage	V _{(BR)CEO}	-60		V	I _C = -10mA, I _B = 0
Emitter-Base Breakdown Voltage	V _{(BR)EBO}	-5.5		V	I _E = -10 A, I _C = 0
Collector Cutoff Current	I _{CBO}		-10	nA	V _{CB} = -50V, I _E = 0
Collector Cutoff Current	I _{CEX}		-50	nA	V _{CE} = -30V, V _{EB(OFF)} = -0.5V
Base Cutoff Current	I _{BL}		-50	nA	V _{CE} = -30V, V _{EB(OFF)} = -0.5V
ON CHARACTERISTICS (Note 4)					
DC Current Gain	h _{FE}	100 100 100 100 50	300		I _C = -100 A, V _{CE} = -10V I _C = -1.0mA, V _{CE} = -10V I _C = -10mA, V _{CE} = -10V I _C = -150mA, V _{CE} = -10V I _C = -500mA, V _{CE} = -10V
Collector-Emitter Saturation Voltage	V _{CE(SAT)}		-0.3 -0.5	V	I _C = -150mA, I _B = -15mA I _C = -500mA, I _B = -50mA
Base-Emitter Saturation Voltage	V _{BE(SAT)}		-0.95 -0.1.3	V	I _C = 150mA, I _B = 15mA I _C = 500mA, I _B = 50mA
SMALL SIGNAL CHARACTERISTICS					
Current Gain-Bandwidth Product	f _T	100		MHz	V _{CE} = 2.0V, I _C = 10mA, f = 100MHz
SWITCHING CHARACTERISTICS					
Turn-On Time	t _{on}		45	ns	
Delay Time	t _d		10	ns	V _{CE} = -30V, I _C = -150mA, I _{B1} = I _{B2} = -15mA
Rise Time	t _r		40	ns	
Turn-Off Time	t _{off}		100	ns	
Storage Time	t _s		80	ns	V _{CC} = -6.0V, I _C = -150mA, I _{B1} = I _{B2} = -15mA
Fall Time	t _r		30	ns	

Electrical Characteristics @ T_A = 25 C unless otherwise specified
NPN (MMBTA06) Transistor (Q2):

Characteristic	Symbol	Min	Typ	Max	Unit	Test Condition
OFF CHARACTERISTICS (Note 4)						
Collector-Base Breakdown Voltage	V _{(BR)CBO}	80			V	I _C = 100 A, I _E = 0
Collector-Emitter Breakdown Voltage	V _{(BR)CEO}	65			V	I _C = 1mA, I _B = 0
Emitter-Base Breakdown Voltage	V _{(BR)EBO}	6			V	I _E = 100 A, I _C = 0
Collector-Base Cutoff Current	I _{CBO}			100	nA	V _{CB} = 80V, I _E = 0
Collector Cutoff Current	I _{CES}			100	nA	V _{CE} = 90V, V _{BE} = 0
Collector-Emitter Cutoff Current, I _{O(OFF)}	I _{CEO}			100	nA	V _{CE} = 30V, I _B = 0
Emitter-Base Cutoff Current	I _{EBO}			100	nA	V _{EB} = 5V, I _C = 0
ON CHARACTERISTICS (Note 4)						
DC Current Gain	h _{FE}	250				V _{CE} = 1V, I _C = 10mA
		100				V _{CE} = 1V, I _C = 100mA
Collector-Emitter Saturation Voltage	V _{CE(SAT)}		0.2	0.4	V	I _C = 100mA, I _B = 10mA
Base-Emitter Turn-on Voltage	V _{BE(ON)}	0.7	0.75	0.8	V	V _{CE} = 1V, I _C = 100mA
Base-Emitter Saturation Voltage	V _{BE(SAT)}			0.95	V	I _C = 100mA, I _B = 5mA
SMALL SIGNAL CHARACTERISTICS						
Current Gain-Bandwidth Product	f _T	100			MHz	V _{CE} = 20V, I _C = 10mA, f = 100MHz

Notes: 4. Short duration pulse test used to minimize self-heating effect.

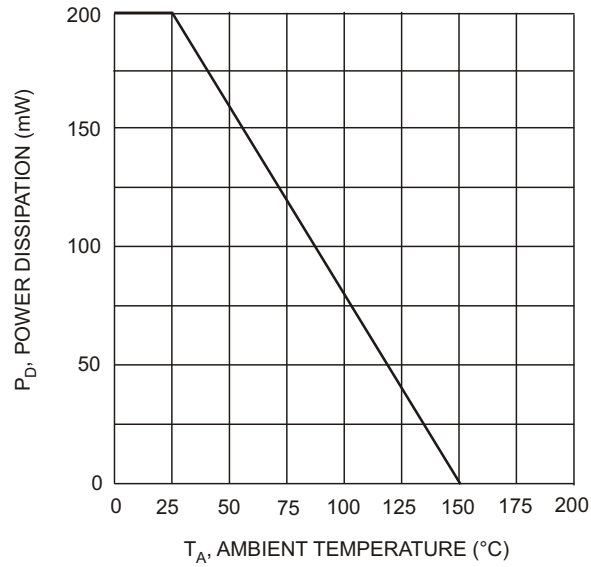

Fig. 3 Power Derating Curve

PNP (MMBT2907A) Transistor (Q1) Plots:

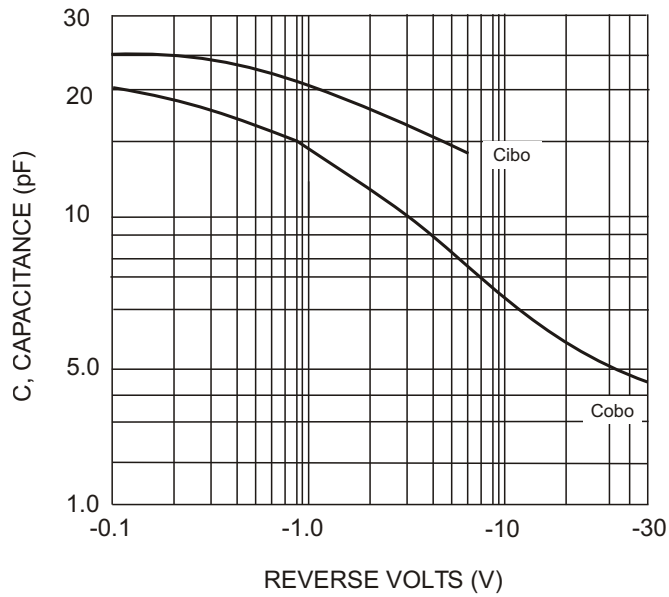

Fig. 4 Typical Capacitance

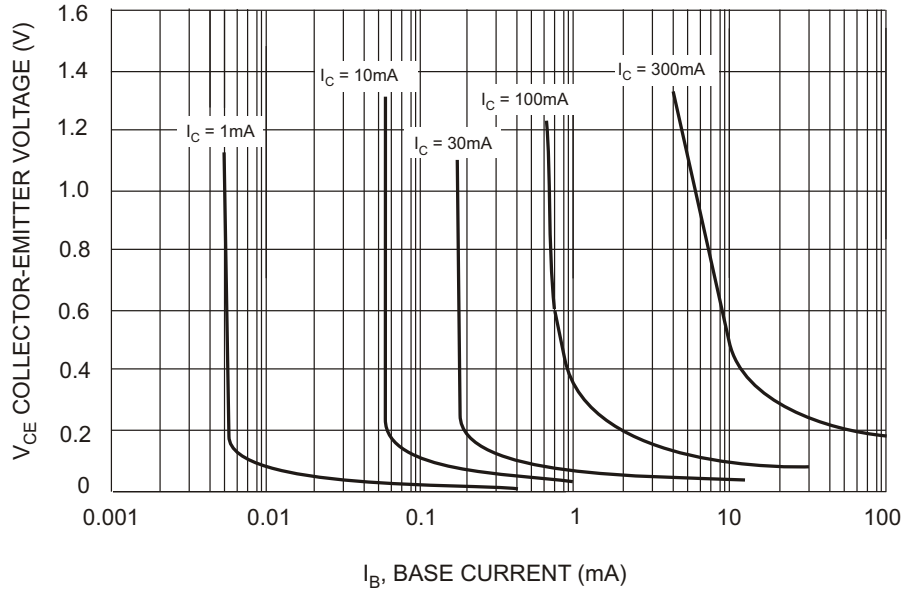

Fig. 5 Typical Collector Saturation Region

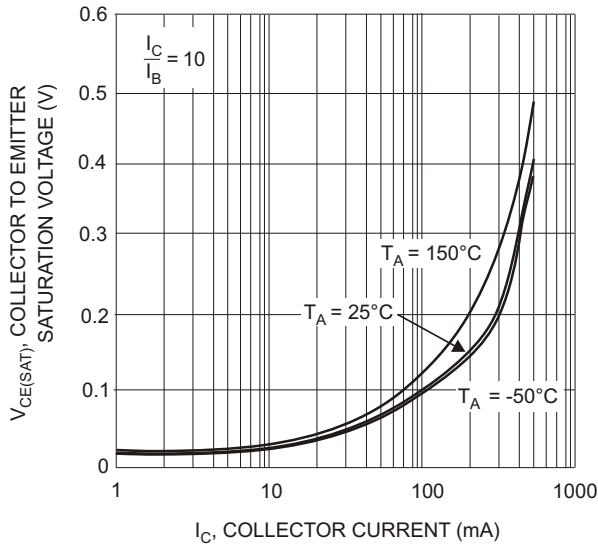

Fig. 6 Collector Emitter Saturation Voltage vs. Collector Current

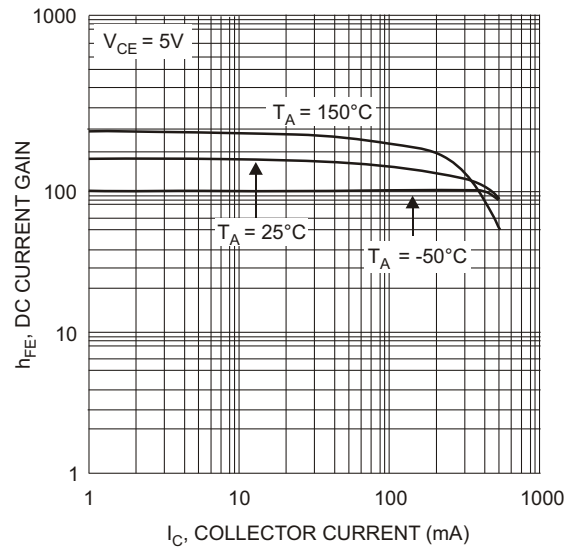

Fig. 7 DC Current Gain vs Collector Current

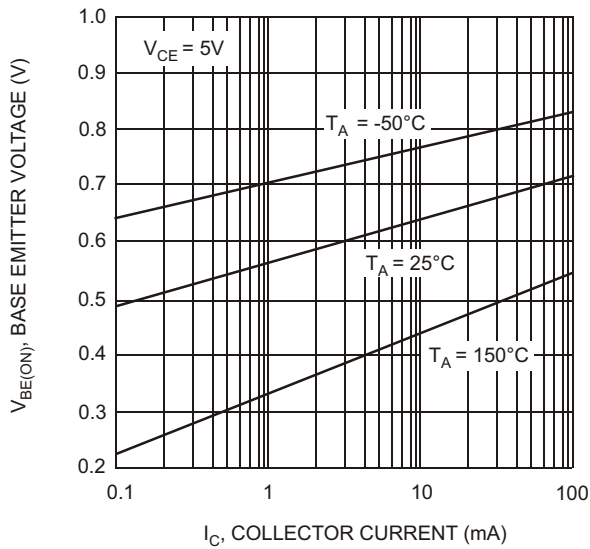

Fig. 8 Base Emitter Voltage vs. Collector Current

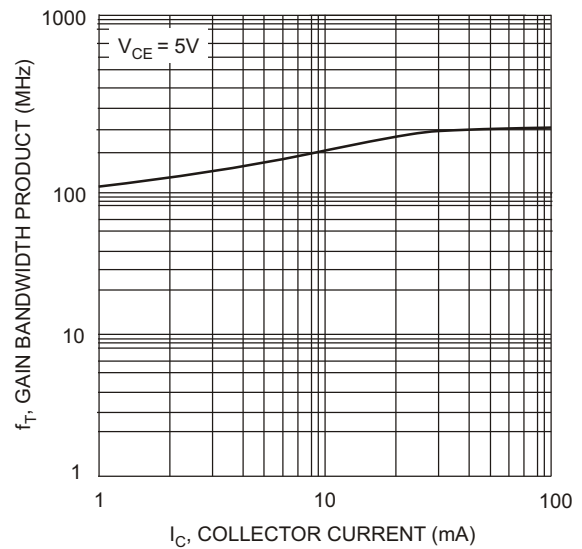

Fig. 9 Gain Bandwidth Product vs. Collector Current

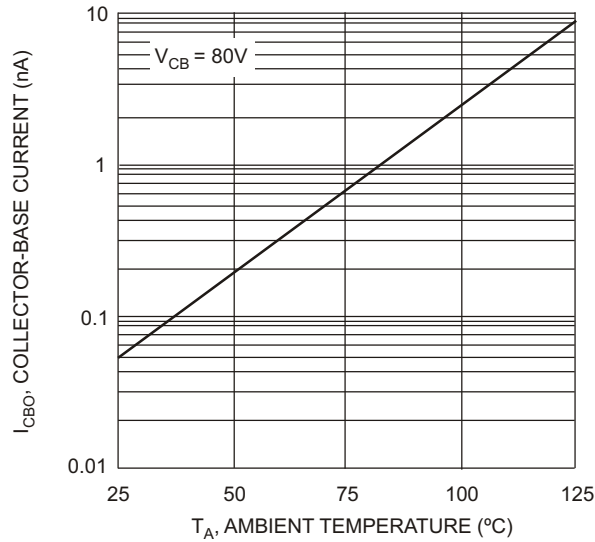

Fig. 10 Typical Collector-Cutoff Current vs. Ambient Temperature

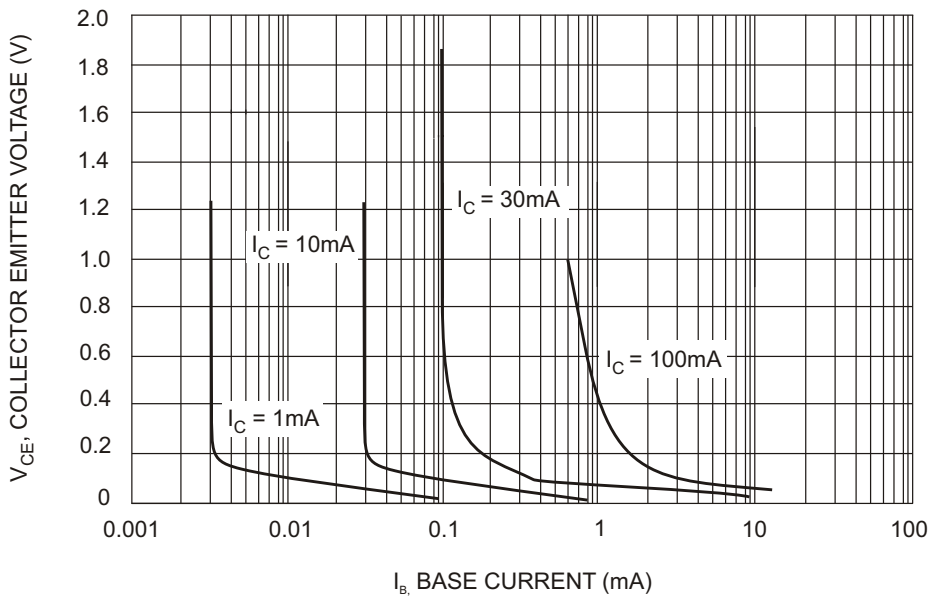

Fig. 11 Typical Collector Saturation Region

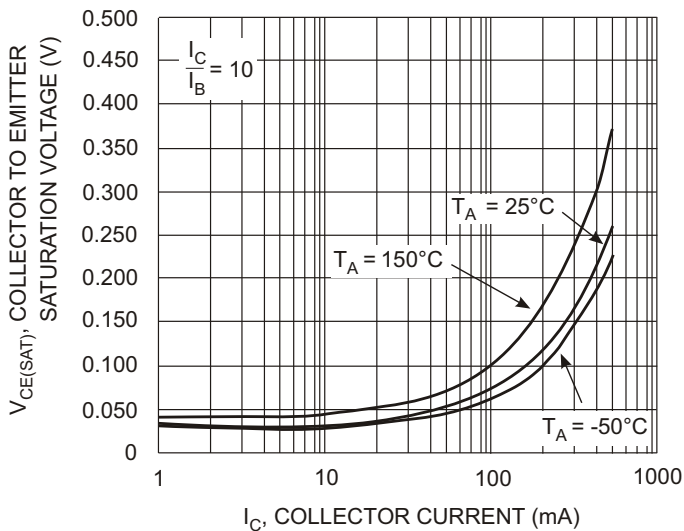

Fig. 12 Collector Emitter Saturation Voltage vs. Collector Current

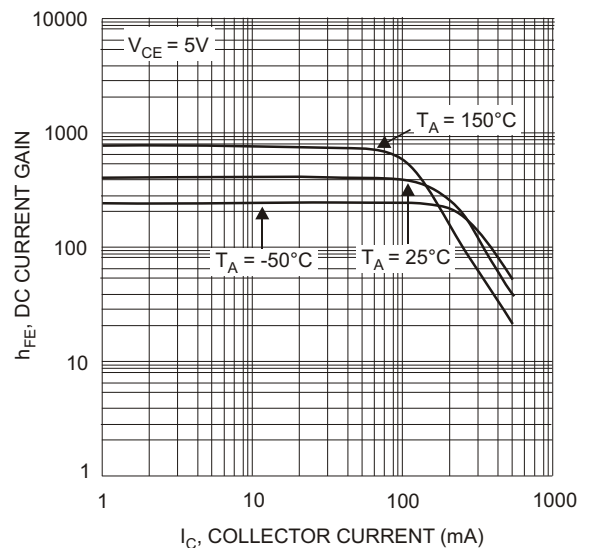
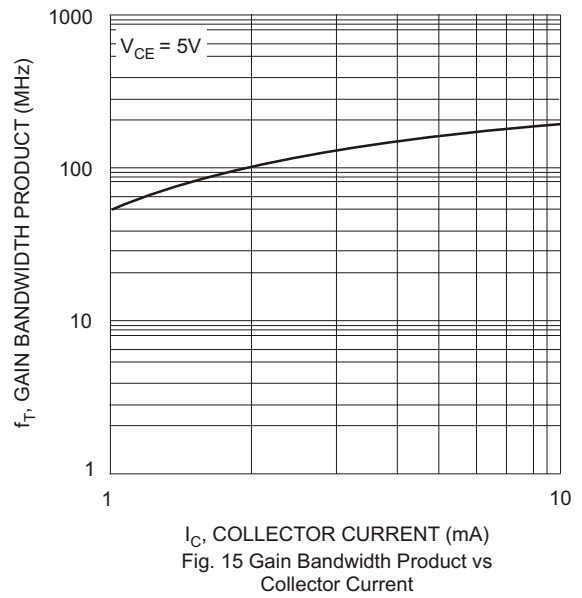
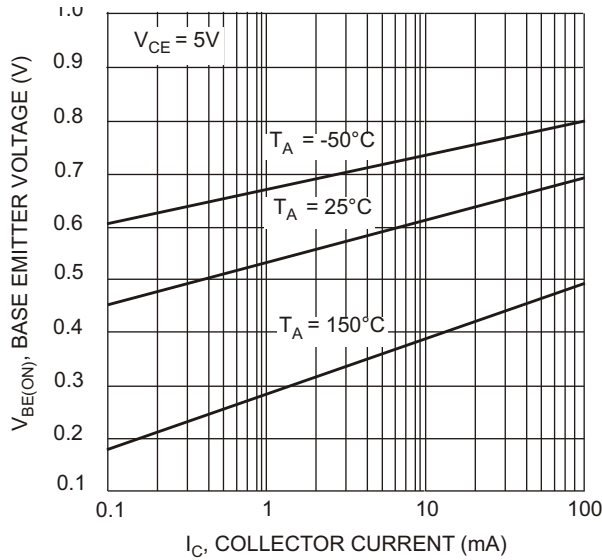

Fig. 13 DC Current Gain vs. Collector Current



Circuit Schematic along with Application Example:

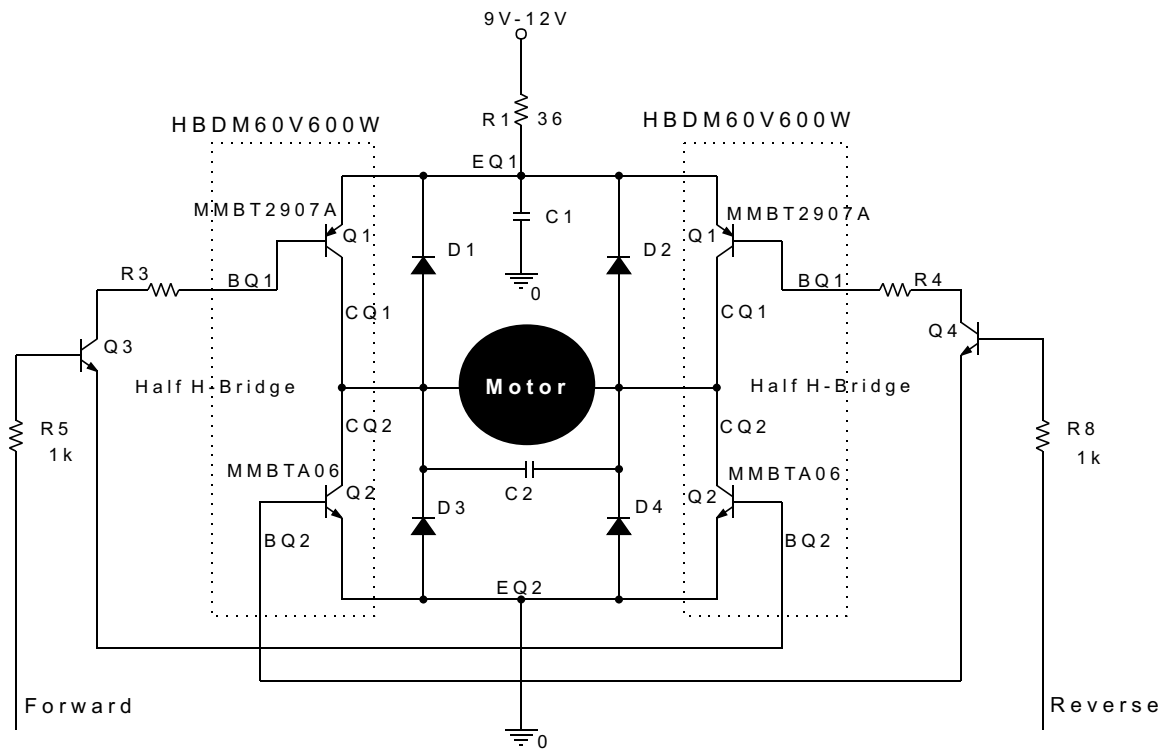

Fig. 16

Note: D₁, D₂, D₃, D₄: Switching Diodes (MMBD4448)
Q₃, Q₄: NPN Transistors (MMBTA06)

Application Example Schematic: (with Package Pinouts)

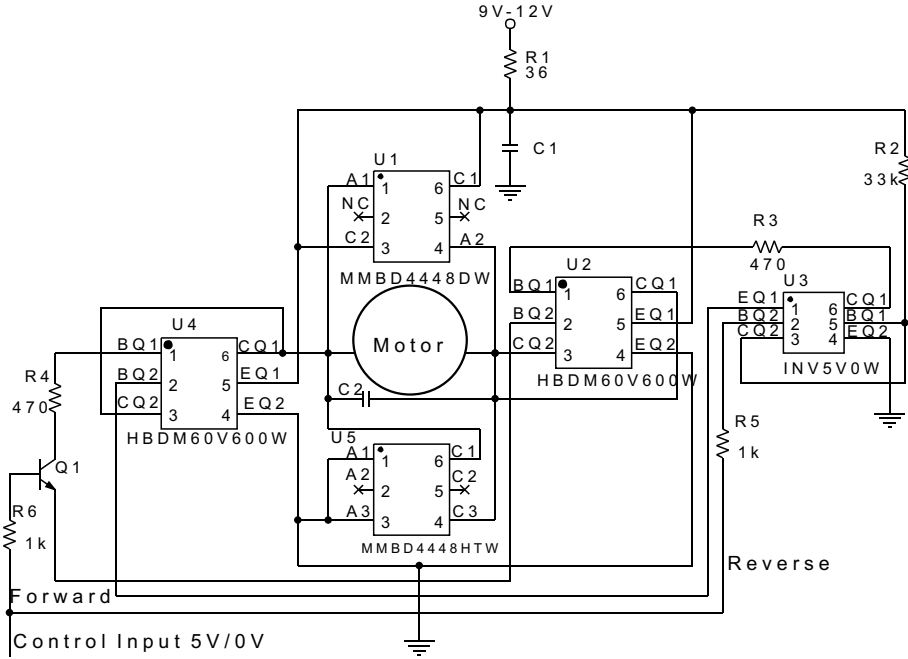

Fig. 17

Ordering Information (Note 5)

Device	Packaging	Shipping
HBDM60V600W-7	HB01	3000/Tape & Reel

Notes: 5. For Packaging Details, please go to page 8 or our website at <http://www.diodes.com/datasheets/ap02007.pdf>.

Marking Information

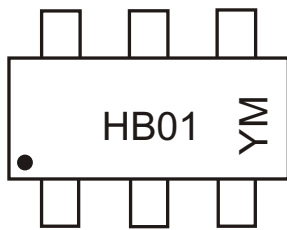

Fig. 18

HB01 = Product Type Marking Code
 YM = Date Code Marking
 Y = Year ex: T = 2006
 M = Month ex: 9 = September

Date Code Key

Year	2006	2007	2008	2009	2010	2011	2012
Code	T	U	V	W	X	Y	Z

Month	Jan	Feb	March	Apr	May	Jun	Jul	Aug	Sep	Oct	Nov	Dec
Code	1	2	3	4	5	6	7	8	9	O	N	D

Mechanical Details

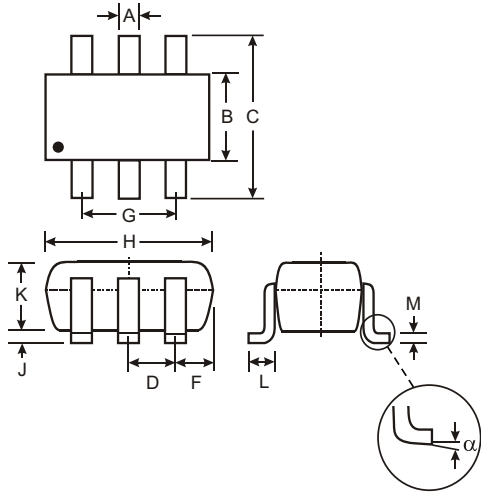

SOT-363		
Dim	Min	Max
A	0.10	0.30
B	1.15	1.35
C	2.00	2.20
D	0.65 Nominal	
F	0.30	0.40
H	1.80	2.20
J		0.10
K	0.90	1.00
L	0.25	0.40
M	0.10	0.25
	0	8°
All Dimensions in mm		

Fig. 19

Suggested Pad Layout: (Based on IPC-SM-782)

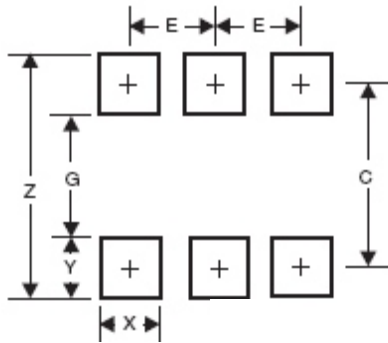

Fig. 20

Figure 20 Dimensions	SOT-363*
Z	2.5
G	1.3
X	0.42
Y	0.6
C	1.9
E	0.65

* Typical dimensions in mm

IMPORTANT NOTICE

Diodes Incorporated and its subsidiaries reserve the right to make modifications, enhancements, improvements, corrections or other changes without further notice to any product herein. Diodes Incorporated does not assume any liability arising out of the application or use of any product described herein; neither does it convey any license under its patent rights, nor the rights of others. The user of products in such applications shall assume all risks of such use and will agree to hold Diodes Incorporated and all the companies whose products are represented on our website, harmless against all damages.

LIFE SUPPORT

Diodes Incorporated products are not authorized for use as critical components in life support devices or systems without the expressed written approval of the President of Diodes Incorporated.