

## Features

- Very Low Power Consumption: 50  $\mu$ W
- Low Insertion Loss: 1.0 dB
- High Isolation: 35 dB up to 2 GHz
- Very High Intercept Point: 46 dBm IP3
- Nanosecond Switching Speed
- Temperature Range: -40°C to +85°C
- Low Cost SOIC-8 Plastic Package
- Tape and Reel Packaging Available

## Description

M/A-COM's SW-259 is a GaAs MMIC SPST switch in a low cost SOIC-8 lead surface mount plastic package. The SW-259 is ideally suited for use where low power consumption is required. Typical applications include transmit/receive switching, switch matrices and switched filter banks in systems such as radio and cellular equipment, PCM, GPS, fiber optic modules, and other battery powered radio equipment.

The SW-259 is fabricated using a monolithic GaAs MMIC using a mature 1 micron process. The process features full chip passivation for increased performance and reliability.

## Ordering Information <sup>1</sup>

Part Number	Package
SW-259 PIN	Bulk Packaging
SW-259TR	1000 piece reel

1. Reference Application Note M513 for reel size information.

## Functional Schematic

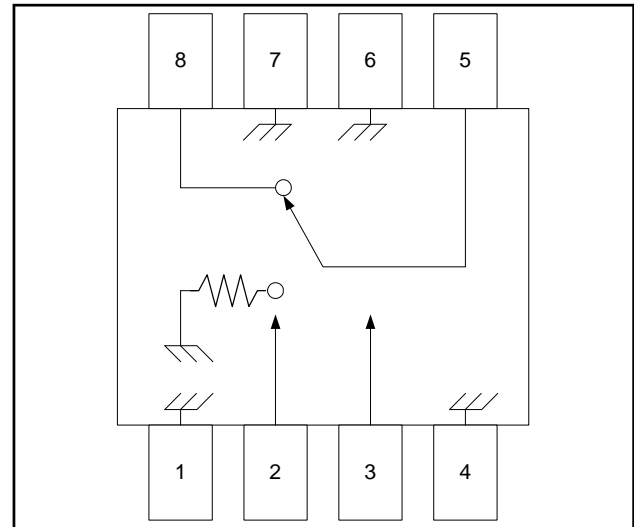

## Pin Configuration

PIN No.	Description	PIN No.	Description
1	Ground	5	RF2
2	A	6	Ground
3	B	7	Ground
4	Ground	8	RF1

## Absolute Maximum Ratings <sup>2</sup>

Parameter	Absolute Maximum
Input Power <sup>3</sup> 0.05 GHz 0.5-2.0 GHz	+27 dBm +34 dBm
Control Voltage	+5 V, -8.5 V
Storage Temperature	-65°C to +150°C

2. Exceeding any one or combination of these limits may cause permanent damage to this device.
3. When the RF Input power is applied to a terminated port, the absolute maximum is +32 dBm.

**Electrical Specifications:  $T_A = +25^\circ\text{C}$  <sup>4</sup>**

Parameter	Test Conditions	Units	Min	Typ	Max
Insertion Loss	DC - 0.1 GHz	dB	—	0.5	0.6
	DC - 0.5 GHz	dB	—	0.8	1.0
	DC - 1.0 GHz	dB	—	1.0	1.2
	DC - 2.0 GHz	dB	—	1.4	1.6
Isolation	DC - 0.1 GHz	dB	62	65	—
	DC - 0.5 GHz	dB	55	58	—
	DC - 1.0 GHz	dB	45	48	—
	DC - 2.0 GHz	dB	32	35	—
VSWR On VSWR Off	DC - 2.0 GHz	Ratio	1.2:1	—	—
	DC - 2.0 GHz	Ratio	1.2:1	—	—
1 dB Compression	Input Power	dBm	—	18	—
	0.05 GHz 0.5-2.0 GHz	dBm	—	23	—
Trise, Tfall	10% to 90% RF, 90% to 10% RF	nS	—	4	
Ton, Toff	50% Control to 90% RF, 50% Control to 10% RF	nS	—	8	
Transients	In-Band	mV	—	35	
2nd Order Intercept	Measured Relative to Input Power, two-tone up to +5 dBm				
	0.05 GHz 0.5 - 2.0 GHz	dBm dBm	— —	55 68	— —
3rd Order Intercept	Measured Relative to Input Power, two-tone up to +5 dBm				
	0.05 GHz 0.5 - 2.0 GHz	dBm dBm	— —	40 46	— —

4. All measurements with 0, -5 V control voltages at 1 GHz in a 50Ω system, unless otherwise specified.

## SOIC-8

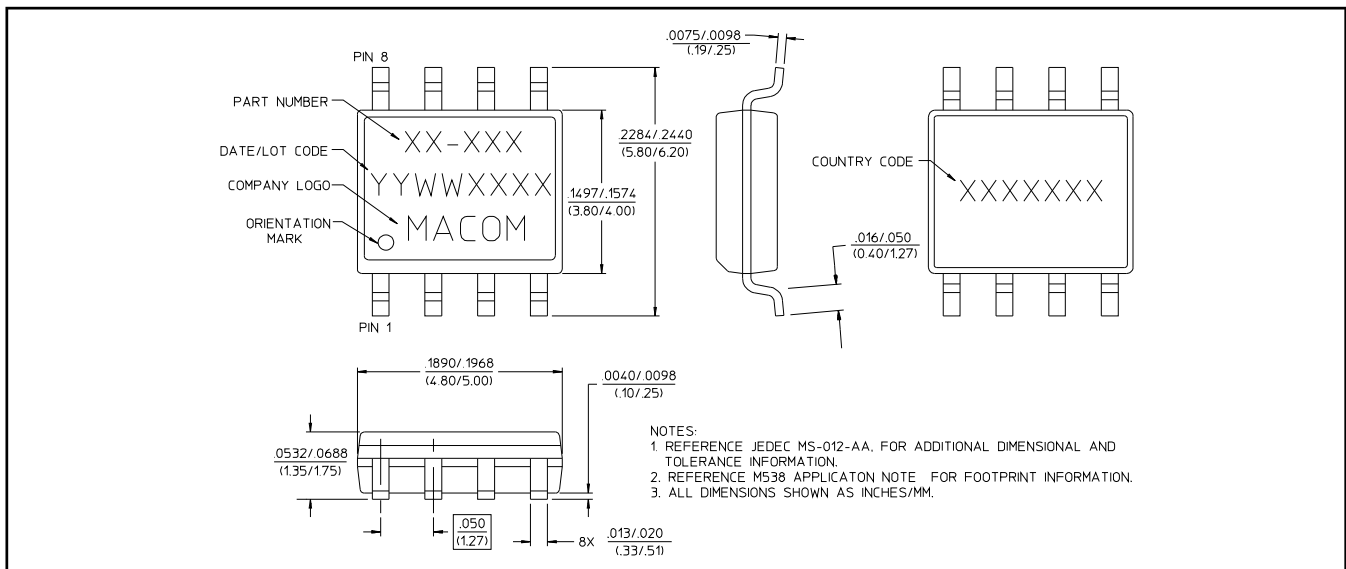

## Electrical Schematic

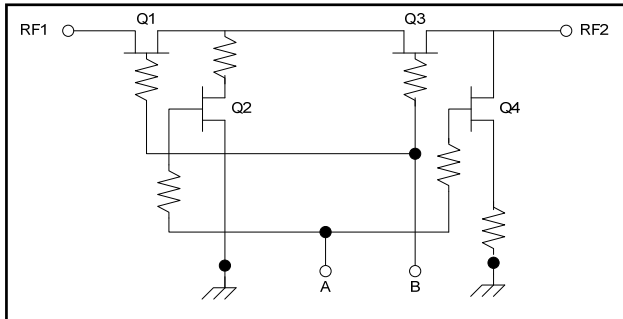

## Truth Table <sup>5,6</sup>

Control Inputs		Condition of Switch
A	B	RF State
1	0	On
0	1	Off

5. "0" = 0 to -0.2 V @ 20 mA max.

6. "1" = -5 V @ 20 mA Typ to -8V @ 600 mA max.

## Typical Performance Curves

### Insertion Loss

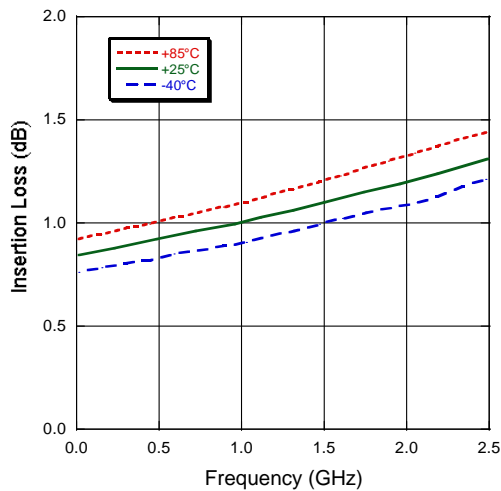

### Isolation

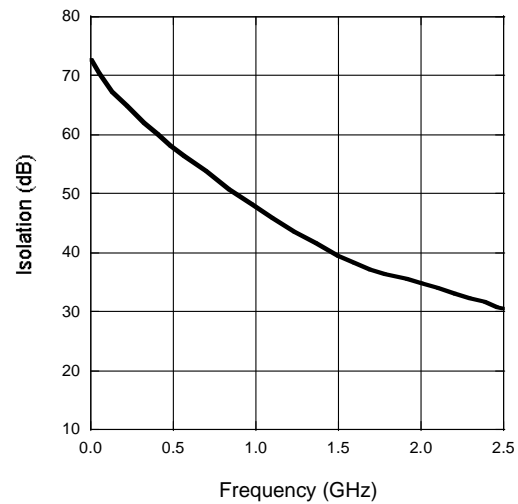

### VSWR

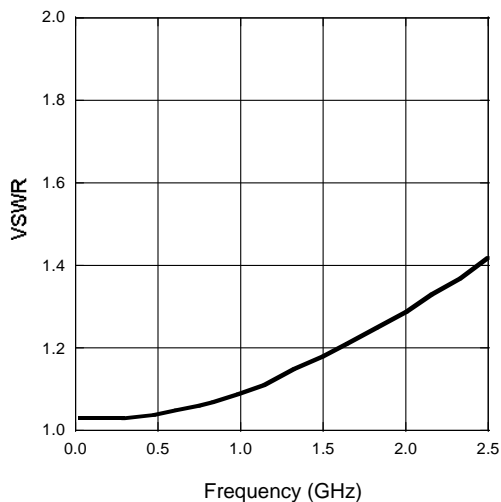

## Swept Data Characterized in 75 Ohms

### Isolation

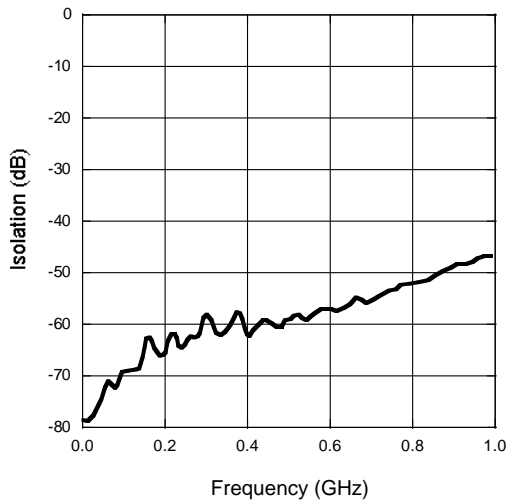

### Input Return Loss - On

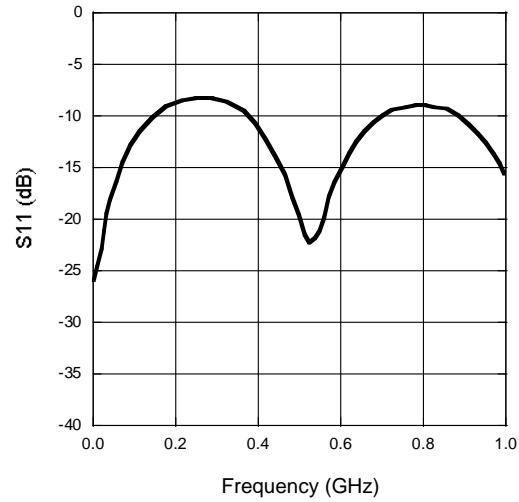

### Output Return Loss - On

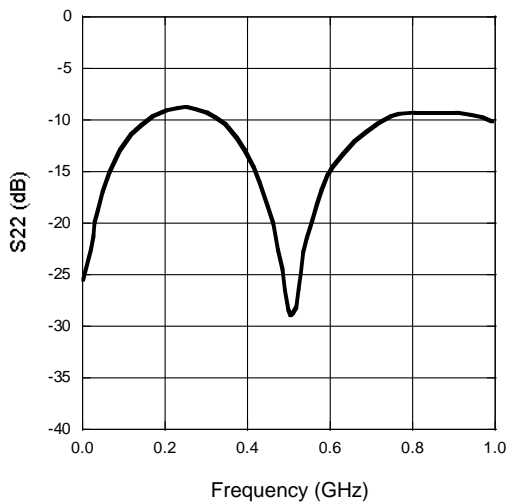

### Output Return Loss - Off

