



# TSM1121

## 3.3V 5V 12V HOUSEKEEPING IC

- Over voltage protection for 3.3V 5V and 12V without external components
- Under voltage protection for 3.3V 5V and 12V without external components
- Over voltage protection for -12V or -5V with external components
- Externally adjustable under voltage blanking during power up
- Power good input/output
- Externally adjustable pg delay
- Fault output
- Remote output
- Externally adjustable remote delay
- Precision voltage reference
- 2kV ESD protection

### DESCRIPTION

The TSM1121 integrated circuit incorporates all sensing circuitry to regulate and protect from over voltage and under voltage a multiple output power supply (3.3V, 5V and 12V).

TSM1121 incorporates all the necessary functions for Housekeeping features which allow safe operation in all conditions, and very high system integration.

TSM1121 integrates a precise voltage reference.

### APPLICATION

- PC SMPS triple power line housekeeping ic (3.3V 5V 12V)

### ORDER CODE

Part Number	Temperature Range	Package		Marking
		N	D	
TSM1121CN	0 to 85°C	•		TSM1121C
TSM1121CD	0 to 85°C		•	M1121

Note: **N** = Dual in Line Package (DIP)  
**D** = Small Outline Package (SO) - also available in Tape & Reel (DT)

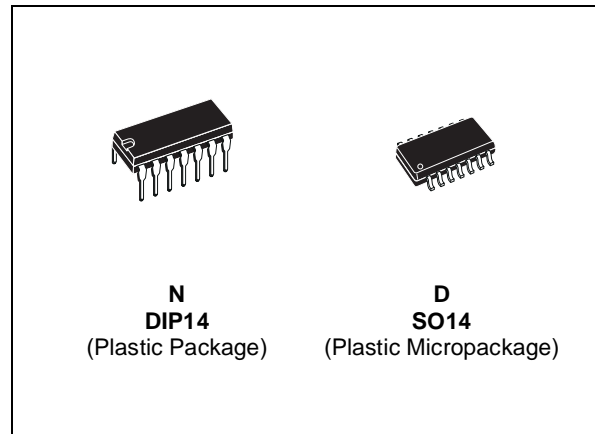

### PIN CONNECTIONS (top view)

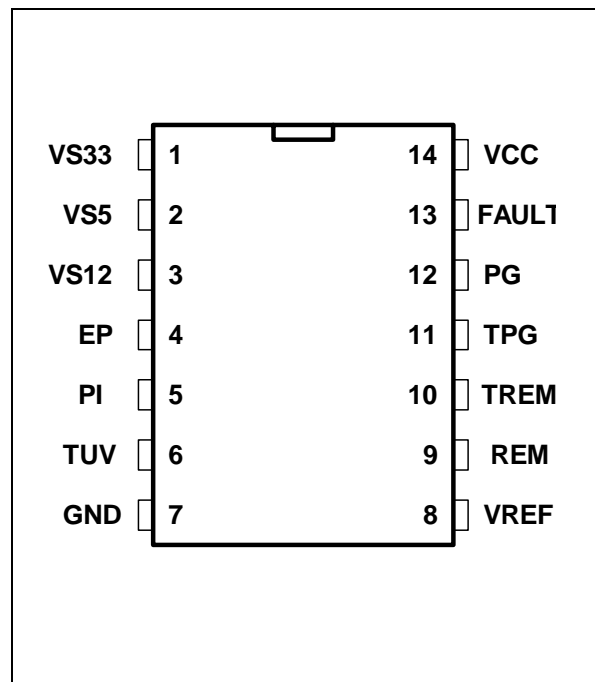

## 1 PIN DESCRIPTION

Name	Pin #	Type	Function
Vcc	14	Power Supply	Positive Power Supply Line
Gnd	7	Power Supply	Ground Line. 0V Reference For All Voltages
Vs12	3	Analog Input	Over and Under voltage Sense Input Dedicated to the 12V Line <sup>1)</sup>
Vs5	2	Analog Input	Over and Under voltage Sense Input Dedicated to the 5V Line <sup>1)</sup>
Vs33	1	Analog Input	Over and Under voltage Sense Input Dedicated to the 3.3V Line <sup>1)</sup>
Tuv	6	Timing Capacitor	Adjustable Under voltage Blanking Delay at Power Up (Setting Capacitor)
Fault	13	Open Collector	Fault Output. Fault is high when Over or Under Voltage has been Detected
PI	5	Analog Input	Power Good Input. Detection of the Power Conditions
PG	12	Open Collector	Power Good Output. PG output is High when the Power Conditions are OK
Tpg	11	Timing Capacitor	Adjustable Power Good Delay (Setting Capacitor)
REM	9	Logic Input	Input Remote Control of the Complete System by the Motherboard ( $\mu$ Controller). Remote is active high. Switch OFF/ON of the Power Supply. Reset of the Complete System after a FAULT Activation.
Trem	10	Timing Capacitor	Adjustable Remote Delay (Setting Capacitor).
Vref	8	Voltage Reference	2.5V Reference for all Voltages
EP	4	Analog Input	Extra Protection Circuit. Can be used for -12V or -5V Over Voltage Protection.

1) Over and Under Voltage Inputs can go higher than Vcc within the allowed Max Rating range

## ABSOLUTE MAXIMUM RATINGS

Symbol	DC Supply Voltage	Value	Unit
Vcc	DC Supply Voltage <sup>1</sup>	25	V
Iout	Output Current Power Good	30	mA
Io	Output current for the Voltage reference	20	mA
VFault	Fault Output	5	V
Pd	Power Dissipation	0.7	W
Tstg	Storage Temperature	-55 to 150	°C
ESD	Electrostatic Discharge	2	kV
Tuv	Adjustable Under voltage Blanking At Power UP	5	V
EP	Extra Protection	5	V
PI	Power Good Input	5	V
PG	Power Good Output	5	V
Tpg	Adjustable Power Good Delay	5	V
REM	Remote Control	5	V
Trem	Adjustable Remote Delay	5	V

1) All voltage values, except differential voltage are with respect to network ground terminal.

## OPERATING CONDITIONS

Symbol	Parameter	Value	Unit
Vcc	DC Supply Conditions	4.5 to 24	V
Toper	Operating Free Air Temperature Range	0 to 85	°C

## Electrical Characteristics

TSM1121

## 2 ELECTRICAL CHARACTERISTICS

Tamb = 25°C and Vcc = 17V (unless otherwise specified)

Symbol	Parameter	Test Condition	Min	Typ	Max	Unit
<b>Total Current Consumption</b>						
Icc	Total Supply Current			3	5	mA
<b>Over Voltage and Under Voltage Protection</b>						
Vov33	Over Voltage Sense 3.3V	Input can go higher than Vcc	3.8	4	4.2	V
Vov5	Over Voltage Sense 5V	Input can go higher than Vcc	5.8	6.1	6.4	V
Vov12	Over Voltage Sense 12V	Input can go higher than Vcc	13.4	14.2	15	V
Vuv33	Under Voltage Sense 3.3V		2.1	2.3	2.5	V
Vuv5	Under Voltage Sense 5V		3.7	4	4.3	V
Vuv12	Under Voltage Sense 12V		9.2	10	10.8	V
Vep	Extra Over voltage Protection Threshold			1.28		V
Tfault	Fault Delay Before Latching	Internally Fixed Delay		100		µs
<b>Under Voltage Blanking During Power Up</b>						
Tuv	Under Voltage Blanking During Power Up (Vcc rising)	Cuv = 2.2µF Adjustable Blanking	100	300	500	ms
Thuv	Blanking Threshold			1.28		V
<b>Power Good (PG)</b>						
Vpgh	Power Good Voltage Threshold			1.28		V
Vpghyst	Power Good Voltage Threshold Hysteresis			70		mV
Vpgo	Low Output Open Collector Saturation Voltage	Collector Current = 15mA			0.4	V
Ipgoh	High Output Open Collector Leakage Current	PG Output = 5V			1	µA
Tpgr	Power Good Output Rise Time	Load Capacitor = 100pF		1		µs
Tpgf	Power Good Output Fall Time	Load Capacitor = 100pF		1		µs
Tpg	Power Good Adjustable Delay	Load Capacitor Cpg=2.2µF	100	300	500	ms
Plth	Power Input Detection Threshold			1.28		V
<b>Fault</b>						
Vfaultol	Fault Output Saturation Voltage Level	IFault = 1mA		1		V
Ifaultoh	Fault Output Leakage Current Level	Vfault = 5V		1		µA
<b>Remote Control (REM)</b>						
Vremth	Remote ON/OFF Input Voltage Threshold		0.7	0.8	1	V
Vremih	High Input Remote Voltage		3.3	3.4		V
Iremil	Low Input Remote Saturation Current				0.5	mA
Trem1	Remote Adjustable Delay ON to OFF	Load Capacitor Crem=0.1µF	40	50	60	ms
Trem2	Remote Adjustable Delay OFF to ON	Load Capacitor Crem=0.1µF	40	50	60	ms
<b>Voltage Reference</b>						
Vref	Internal Voltage Reference	Io = 0mA	2.46	2.5	2.54	V
Regline	Line regulation	Io = 0mA 4.5V < Vcc < 24V		4	10	mV
Regline	Line regulation	Io = 10mA 4.5V < Vcc < 24V		15		mV
Regload	Load regulation <sup>1</sup>	0 < Io < 10mA		25		mV

1) Do not short circuit the Vref Pin





Fig. 3: Detailed Internal Schematic

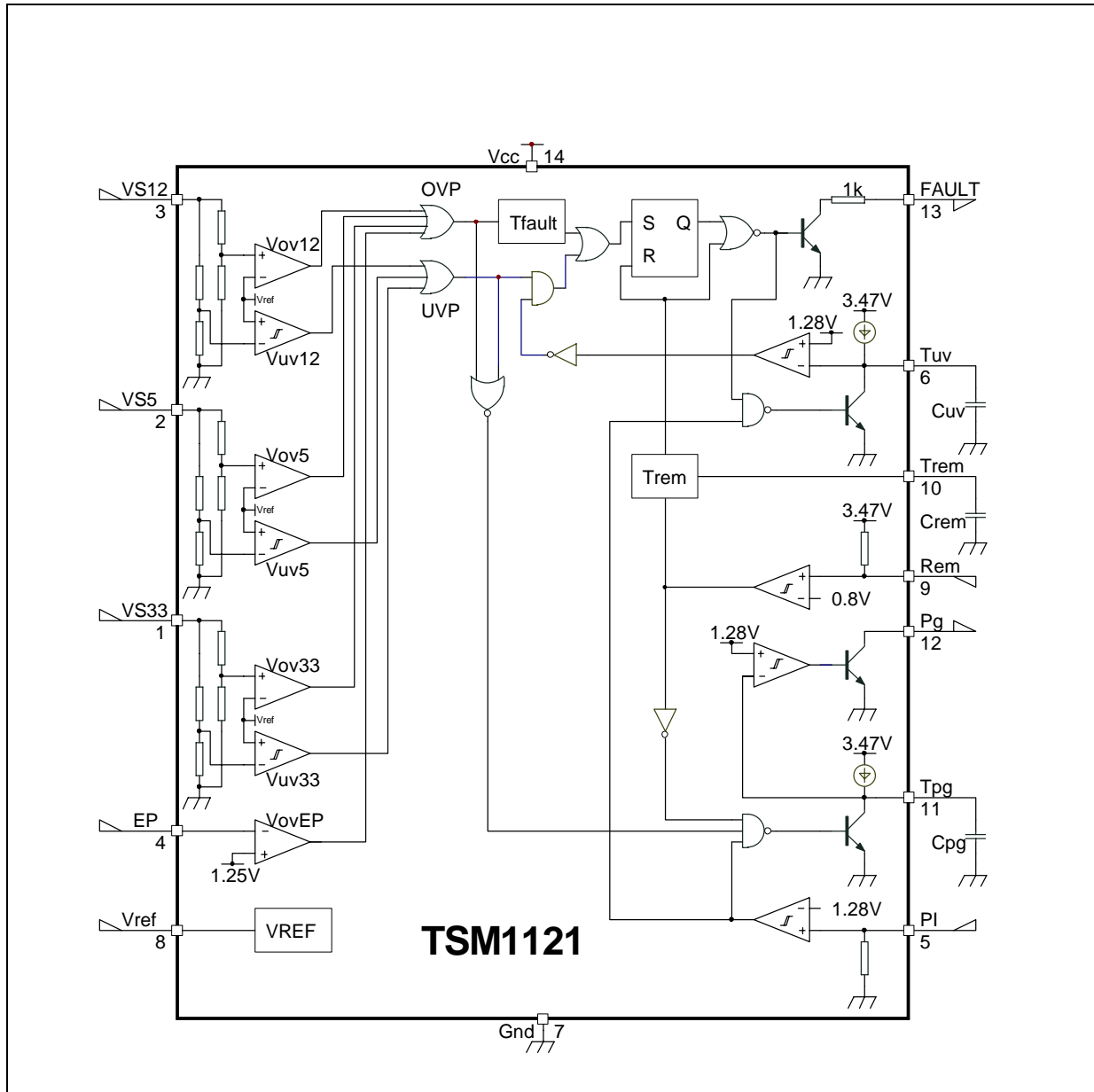

---

# TSM1121

---

## Principle of Operation and Application Hints

---

### TSM1121: Housekeeping IC.

TSM1121 is a one chip solution for all PC SMPS: it integrates on one chip the Housekeeping Circuitry (Over Voltage and Under Voltage protections, with adequate sequencing).

### Triple Power Line Protection

The TSM1121 Housekeeping Circuit is dedicated to 3.3V, 5V and 12V power lines protection. It integrates a Precision Voltage Reference, a Triple Over Voltage Protection Circuit and a Triple Under Voltage Protection Circuit as well as all the necessary logic and transient timing management circuits for optimal and secure communication with the motherboard, during start up, switch off and stabilized conditions.

### Over Voltage Protection

The Over Voltage Protection Circuit is made of three comparators with internal voltage thresholds ( $V_{ov33}$ ,  $V_{ov5}$ ,  $V_{ov12}$ ) which do not require any external components for proper operation. The outputs of these three comparators are ORed.

### Under Voltage Protection

The Under Voltage Protection Circuit is made of three comparators with internal voltage thresholds ( $V_{uv33}$ ,  $V_{uv5}$ ,  $V_{uv12}$ ) which do not require any external components for proper operation. The outputs of these three comparators are ORed, and blanked by an internal delay circuitry (Power Up Blanking -  $T_{uv}$ ) which can be adjusted with an external capacitor ( $C_{uv}$ ). This allows that during power up, the under voltage protection circuit is inhibited.

### Latch OFF

The Over Voltage and Under Voltage Circuits outputs are again ORed before activating a latch. When activated, this latch commands the full switch OFF of the three main power lines (3.3V, 5V, 12V) by an external link between the housekeeping and the primary PWM circuits via the main optocoupler or any other device. Note that the Under Voltage Circuit, after Power Up UV blanking, bears no other delay to the latch setting input whereas the Over Voltage circuit bears an additional  $T_{fault}$  delay time. This allows an efficient protection against Output Short Circuit conditions.

### Power Good

The Over Voltage and Under Voltage Circuits are ORed to switch the Power Good output active (PG) to warn the motherboard that the voltage of at least one of the three power lines is out of range. The PG activation bears an internal  $T_{pg}$  delay circuitry which can be adjusted with an external capacitor ( $C_{pg}$ ).

### Remote Control

Thanks to this information link to the motherboard, a resetting signal to the latch is achievable with the Remote pin (REM). When the Remote pin is active, the external Fault link between Housekeeping circuit and the PWM generator is active (high = PWM OFF) and the PG pin is active (high). Note that to reset effectively the latch, a minimum width Remote pulse should be applied thanks to an internal delay circuitry ( $T_{rem}$ ) which can be adjusted with an external capacitor ( $C_{rem}$ ).

3 APPLICATION INFORMATION

1 - Rem On/Off

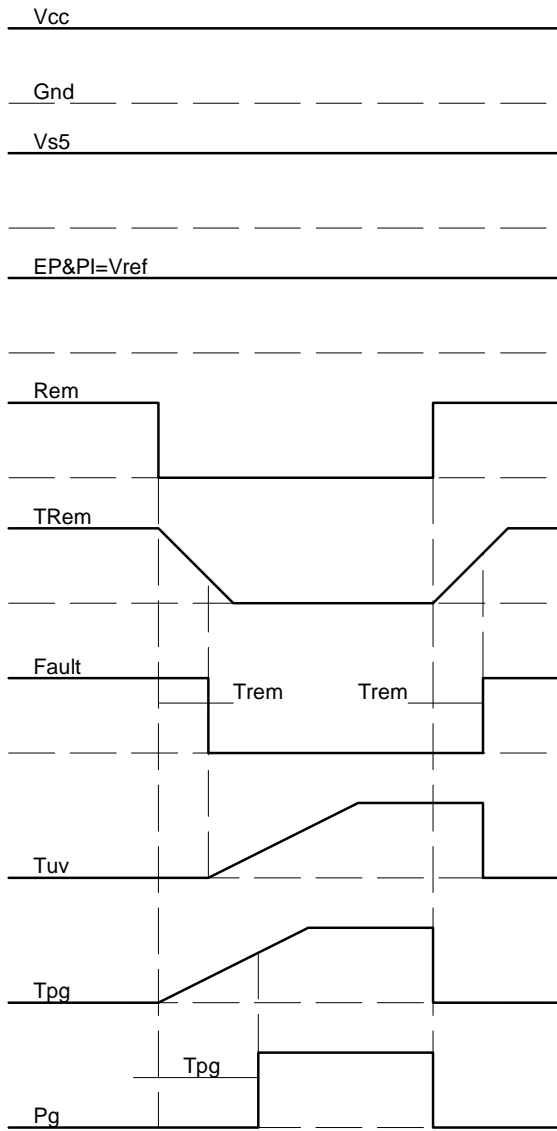

2 - Pi & Vs5 On/Off

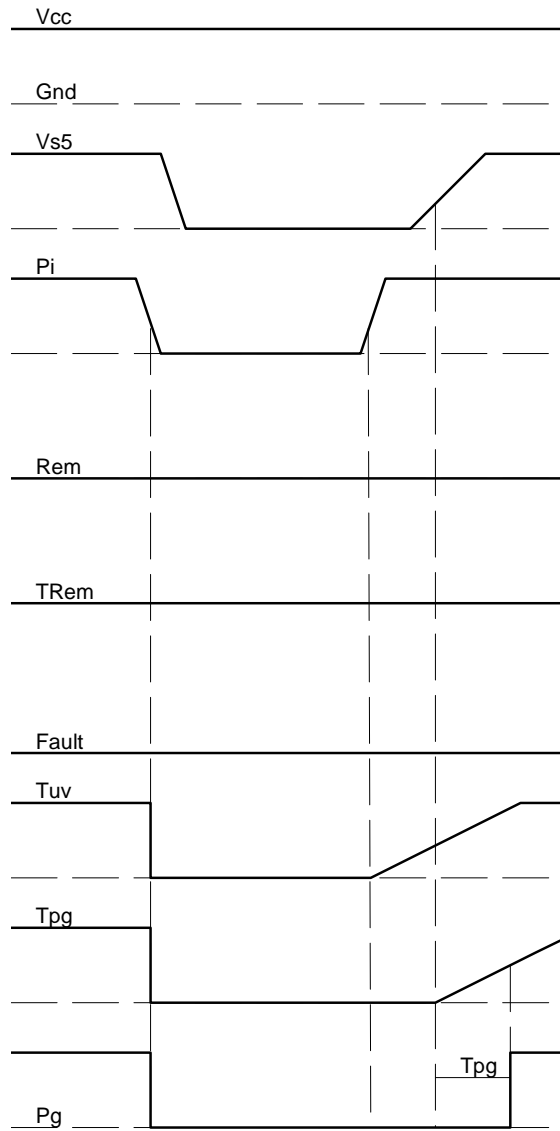

## 3 - OVP Rem On/Off, Tuv start up OK

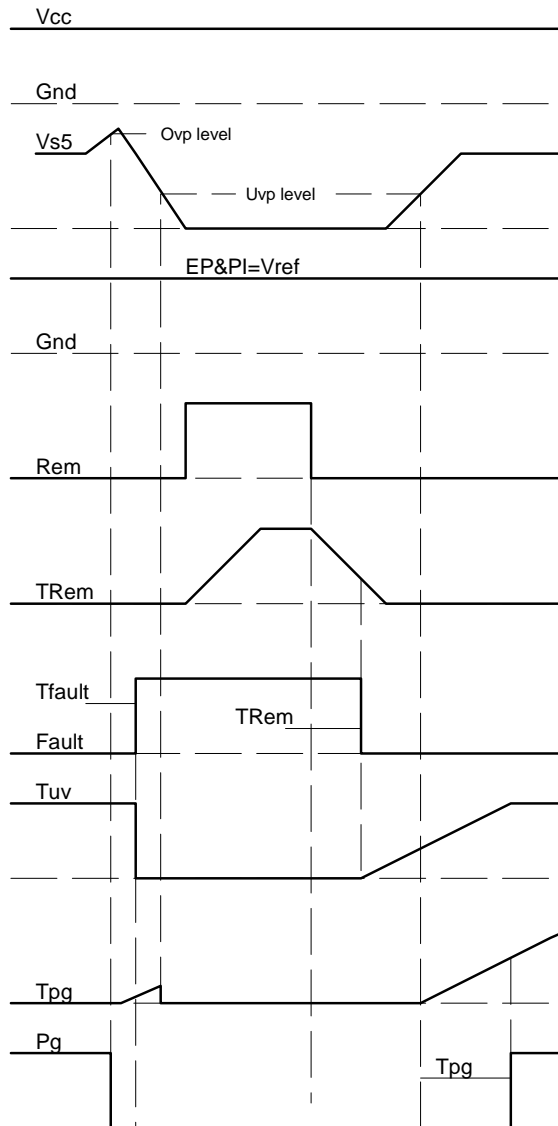

## 4 - OVP Rem On/Off, Tuv start up NOK

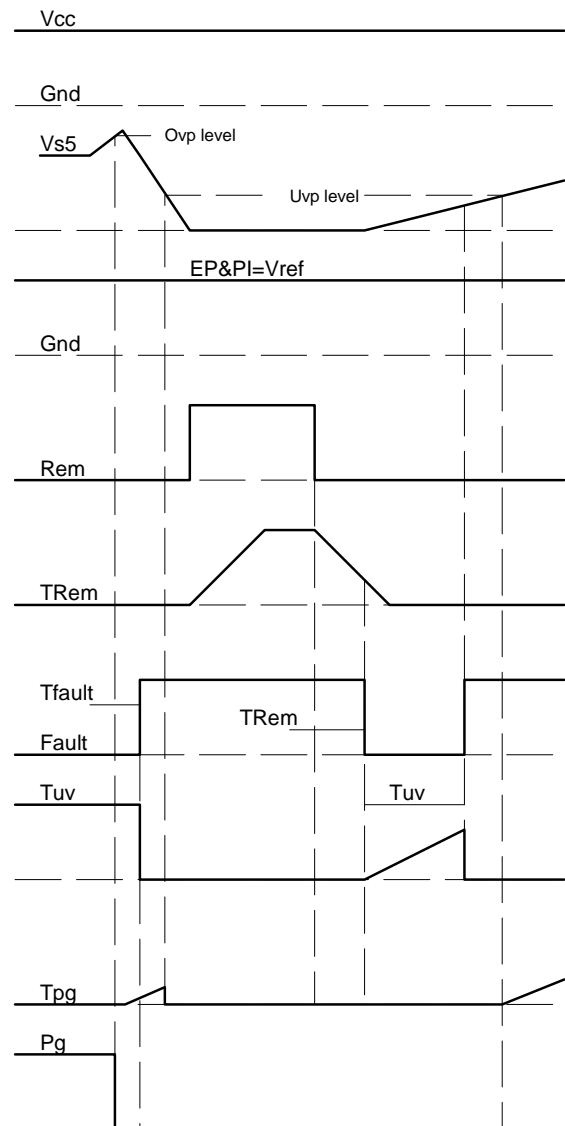



## Truth Table for OVP and UVP detection

EP	PI	Vsxx	Rem	Fault	PG	Power supply state
Vref	Vref	OK	1	1	0	Remote
Vref	Vref	OK	0	0	1	OK
Vref	Vref	OVP on Vsxx	0	1	0	OVP detected
Vref	Vref	OK	0	1	1	Fault latched
Vref	Vref	OK	1	1	0	Remote
Vref	Vref	OK	0	0	1	OK
Vref	<1.28V	OK	0	0	0	UVP detected on PI
Vref	Vref	OK	0	0	1	OK
<1.28V	Vref	OK	0	1	0	UVP detected on EP
Vref	Vref	OK	0	1	0	Fault latched
Vref	Vref	OK	1	1	0	Remote
Vref	Vref	OK	0	0	1	OK

## 4 PACKAGE MECHANICAL DATA

## Plastic DIP-14 MECHANICAL DATA

DIM.	mm.			inch		
	MIN.	TYP.	MAX.	MIN.	TYP.	MAX.
a1	0.51			0.020		
B	1.39		1.65	0.055		0.065
b		0.5			0.020	
b1		0.25			0.010	
D			20			0.787
E		8.5			0.335	
e		2.54			0.100	
e3		15.24			0.600	
F			7.1			0.280
l			5.1			0.201
L		3.3			0.130	
Z	1.27		2.54	0.050		0.100

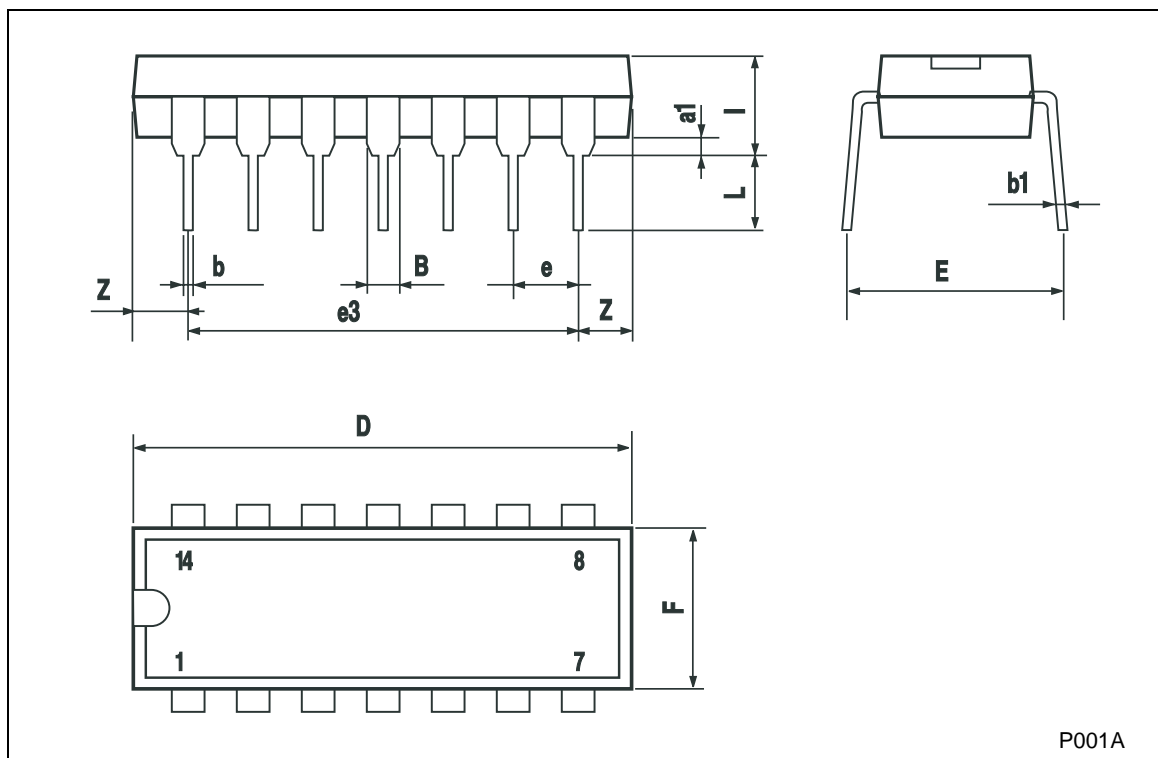

## 5 PACKAGE MECHANICAL DATA

SO-14 MECHANICAL DATA						
DIM.	mm.			inch		
	MIN.	TYP.	MAX.	MIN.	TYP.	MAX.
A			1.75			0.068
a1	0.1		0.2	0.003		0.007
a2			1.65			0.064
b	0.35		0.46	0.013		0.018
b1	0.19		0.25	0.007		0.010
C		0.5			0.019	
c1	45° (typ.)					
D	8.55		8.75	0.336		0.344
E	5.8		6.2	0.228		0.244
e		1.27			0.050	
e3		7.62			0.300	
F	3.8		4.0	0.149		0.157
G	4.6		5.3	0.181		0.208
L	0.5		1.27	0.019		0.050
M			0.68			0.026
S	8° (max.)					

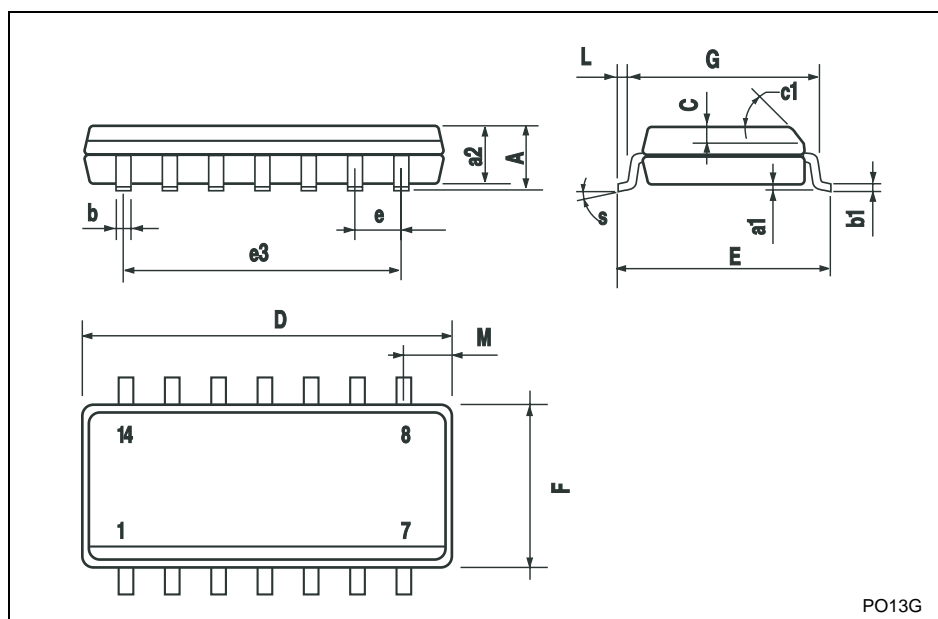

PO13G

Information furnished is believed to be accurate and reliable. However, STMicroelectronics assumes no responsibility for the consequences of use of such information nor for any infringement of patents or other rights of third parties which may result from its use. No license is granted by implication or otherwise under any patent or patent rights of STMicroelectronics. Specifications mentioned in this publication are subject to change without notice. This publication supersedes and replaces all information previously supplied. STMicroelectronics products are not authorized for use as critical components in life support devices or systems without express written approval of STMicroelectronics.

The ST logo is a registered trademark of STMicroelectronics

© 2003 STMicroelectronics - All Rights Reserved  
STMicroelectronics GROUP OF COMPANIES

Australia - Brazil - China - Finland - France - Germany - Hong Kong - India - Italy - Japan - Malaysia - Malta - Morocco  
Singapore - Spain - Sweden - Switzerland - United Kingdom  
<http://www.st.com>

