

FDG6323L Integrated Load Switch

General Description

This device is particularly suited for compact power management in portable electronic equipment where 2.5V to 8V input and 0.6A output current capability are needed. This load switch integrates a small N-Channel power MOSFET (Q1) which drives a large P-Channel power MOSFET (Q2) in one tiny SC70-6 package.

Features

- $V_{DROPP}=0.2V$ @ $V_{IN}=5V$, $I_L=0.36A$. $R_{(ON)} = 0.55\Omega$
 $V_{DROPP}=0.2V$ @ $V_{IN}=2.5V$, $I_L=0.27A$. $R_{(ON)} = 0.75\Omega$.
- Very small package outline SC70-6.
- Control MOSFET (Q1) includes Zener protection for ESD ruggedness (>6KV Human Body Model).
- High density cell design for extremely low on-resistance.
- Compact industry standard SC70-6 surface mount package.

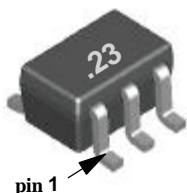
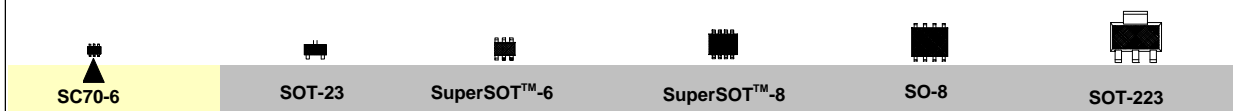

SC70-6

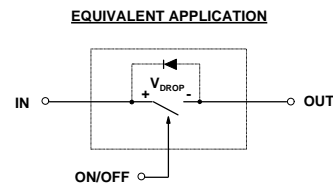
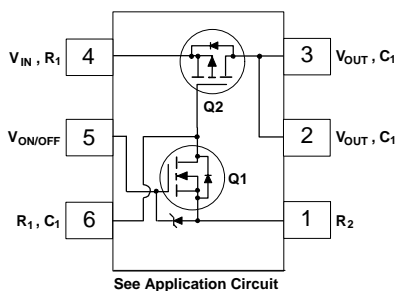

Absolute Maximum Ratings $T_A = 25^\circ\text{C}$ unless otherwise noted

Symbol	Parameter	FDG6323L	Units
V_{IN}	Input Voltage Range	2.5 - 8	V
$V_{ON/OFF}$	On/Off Voltage Range	1.5 - 8	V
I_L	Load Current - Continuous (Note 1)	0.6	A
	- Pulsed (Note 1 & 3)	1.8	
P_D	Maximum Power Dissipation (Note 2)	0.3	W
T_J, T_{STG}	Operating and Storage Temperature Range	-55 to 150	$^\circ\text{C}$
ESD	Electrostatic Discharge Rating MIL-STD-883D Human Body Model (100pf/1500Ohm)	6	kV

THERMAL CHARACTERISTICS

$R_{\theta JA}$	Thermal Resistance, Junction-to-Ambient (Note 2)	415	$^\circ\text{C/W}$
-----------------	--	-----	--------------------

Electrical Characteristics ($T_A = 25^\circ\text{C}$ unless otherwise noted)

Symbol	Parameter	Conditions	Min	Typ	Max	Units
OFF CHARACTERISTICS						
I_{FL}	Forward Leakage Current	$V_{IN} = 8\text{ V}, V_{ON/OFF} = 0\text{ V}$			1	μA
ON CHARACTERISTICS (Note 3)						
V_{DROP}	Conduction Voltage Drop	$V_{IN} = 5\text{ V}, V_{ON/OFF} = 3.3\text{ V}, I_L = 0.36\text{ A}$		0.14	0.2	V
		$V_{IN} = 2.5\text{ V}, V_{ON/OFF} = 3.3\text{ V}, I_L = 0.27\text{ A}$		0.15	0.2	
$R_{(ON)}$	Q_2 - Static On-Resistance	$V_{GS} = -5\text{ V}, I_D = -0.6\text{ A}$		0.41	0.55	Ω
		$V_{GS} = -2.5\text{ V}, I_D = -0.5\text{ A}$		0.58	0.75	
I_L	Load Current	$V_{DROP} = 0.2\text{ V}, V_{IN} = 5\text{ V}, V_{ON/OFF} = 3.3\text{ V}$	0.36			A
		$V_{DROP} = 0.2\text{ V}, V_{IN} = 2.5\text{ V}, V_{ON/OFF} = 3.3\text{ V}$	0.27			

Notes:

- Range of V_{in} can be up to 8V, but R_1 and R_2 must be scaled such that V_{GS} of Q_2 does not exceed -8V.
- R_{thJA} is the sum of the junction-to-case and case-to-ambient thermal resistance where the case thermal reference is defined as the solder mounting surface of the drain pins.
 R_{thJC} is guaranteed by design while R_{thCA} is determined by the user's board design.
- Pulse Test: Pulse Width $\leq 300\mu\text{s}$, Duty Cycle $\leq 2.0\%$

FDG6323L Load Switch Application

APPLICATION CIRCUIT

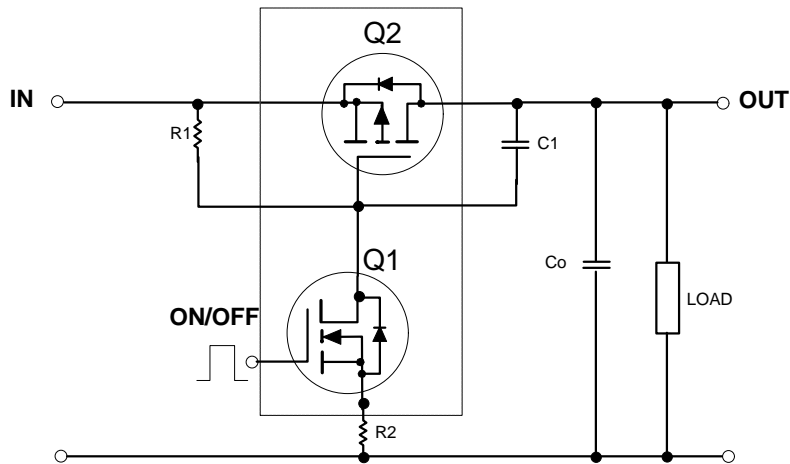

External Component Recommendation

R_1 is required to turn Q_2 off.
 R_2 is optional for Slew Rate Control.

For $C_o \leq 1\mu\text{F}$ applications:

First select R_2 , 100 - 1K Ω , for Slew Rate control.

Then select R_1 such that R_1/R_2 ratio maintains between 10 - 100.

Typical Electrical Characteristics ($T_A = 25\text{ }^\circ\text{C}$ unless otherwise noted)

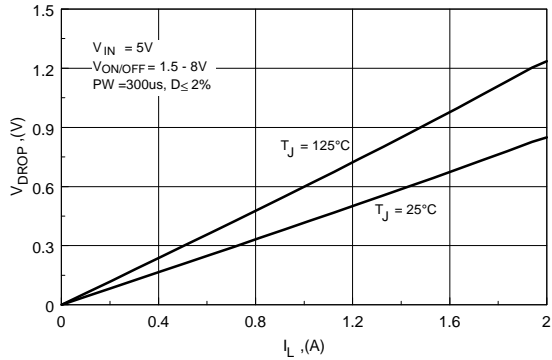

Figure 1. Conduction Voltage Drop Variation with Load Current.

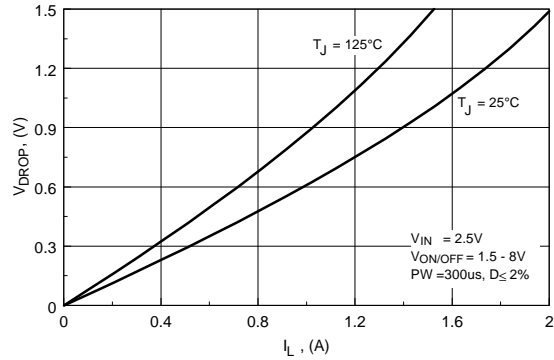

Figure 2. Conduction Voltage Drop Variation with Load Current.

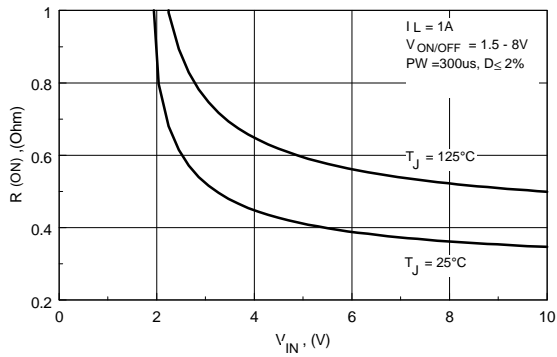

Figure 3. On-Resistance Variation with Input Voltage.

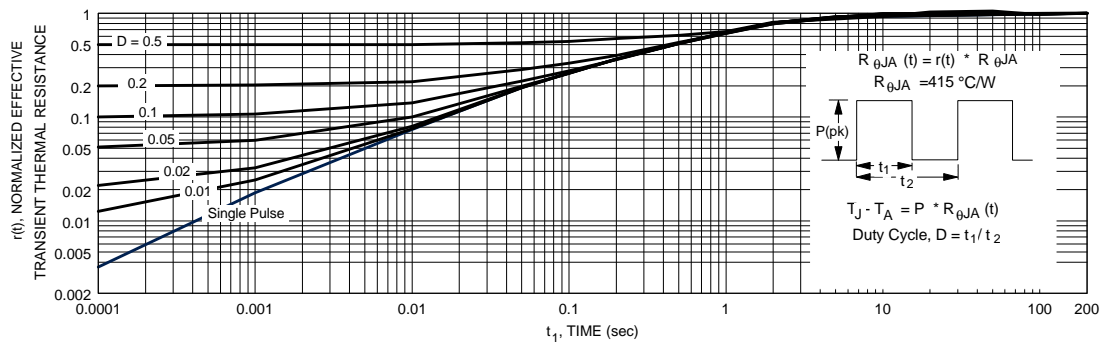

Figure 4. Transient Thermal Response Curve.

Thermal characterization performed using the conditions described in Note 2.
 Transient thermal response will change depending on the circuit board design.

SC70-6 Tape and Reel Data and Package Dimensions



SC70-6 Packaging Configuration: Figure 1.0

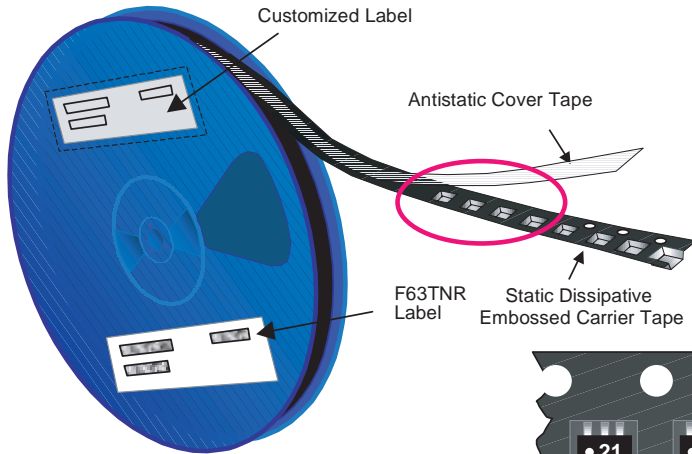

Packaging Description:

SC70-6 parts are shipped in tape. The carrier tape is made from a dissipative (carbon filled) polycarbonate resin. The cover tape is a multilayer film (Heat Activated Adhesive in nature) primarily composed of polyester film, adhesive layer, sealant, and anti-static sprayed agent. These reeled parts in standard option are shipped with 3,000 units per 7" or 177cm diameter reel. The reels are dark blue in color and is made of polystyrene plastic (anti-static coated). Other option comes in 10,000 units per 13" or 330cm diameter reel. This and some other options are described in the Packaging Information table.

These full reels are individually barcode labeled and placed inside a pizza box (illustrated in figure 1.0) made of recyclable corrugated brown paper with a Fairchild logo printing. One pizza box contains three reels maximum. And these pizza boxes are placed inside a barcode labeled shipping box which comes in different sizes depending on the number of parts shipped.

SC70-6 Packaging Information		
Packaging Option	Standard (no flow code)	D87Z
Packaging type	TNR	TNR
Qty per Reel/Tube/Bag	3,000	10,000
Reel Size	7" Dia	13"
Box Dimension (mm)	184x187x47	343x343x64
Max qty per Box	9,000	30,000
Weight per unit (gm)	0.0055	0.0055
Weight per Reel (kg)	0.1140	0.3960
Note/Comments		

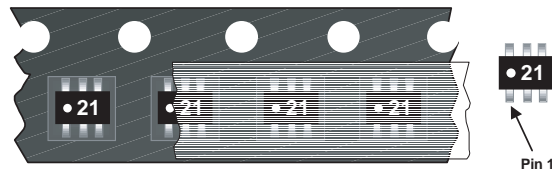

SC70-6 Unit Orientation

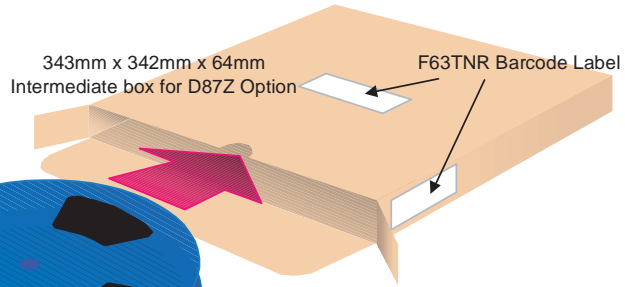
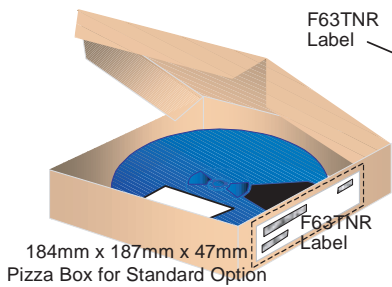

F63TNR Label sample



SC70-6 Tape Leader and Trailer Configuration: Figure 2.0

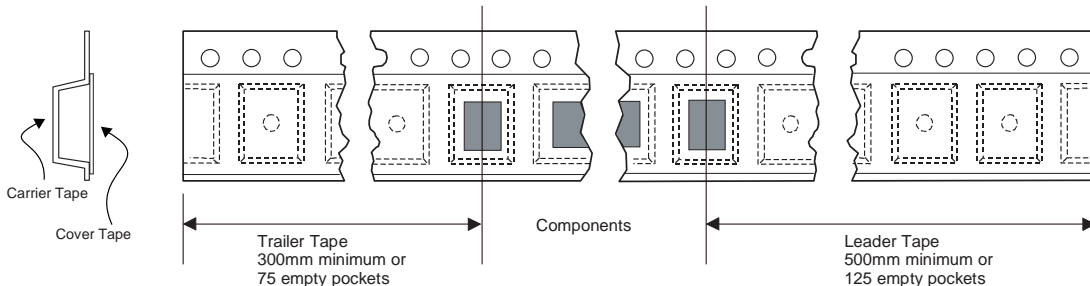

SC70-6 Tape and Reel Data and Package Dimensions, continued

SC70-6 Embossed Carrier Tape Configuration: Figure 3.0

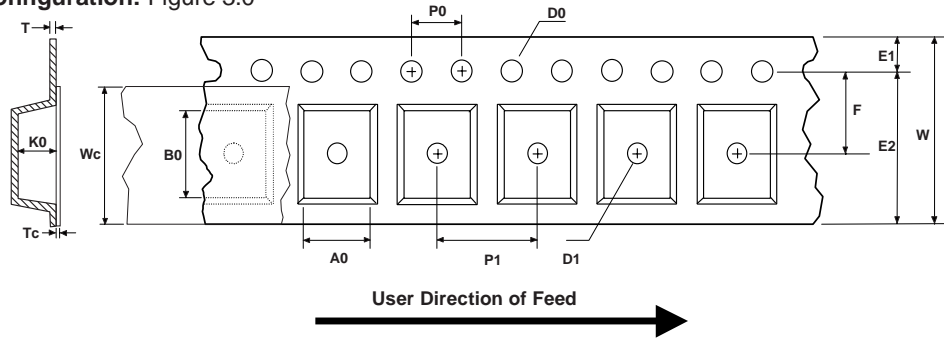

Dimensions are in millimeter														
Pkg type	A0	B0	W	D0	D1	E1	E2	F	P1	P0	K0	T	Wc	Tc
SC70-6 (8mm)	2.24 +/-0.10	2.34 +/-0.10	8.0 +/-0.3	1.55 +/-0.05	1.125 +/-0.125	1.75 +/-0.10	6.25 min	3.50 +/-0.05	4.0 +/-0.1	4.0 +/-0.1	1.20 +/-0.10	0.255 +/-0.150	5.2 +/-0.3	0.06 +/-0.02

Notes: A0, B0, and K0 dimensions are determined with respect to the EIA/Jedec RS-481 rotational and lateral movement requirements (see sketches A, B, and C).

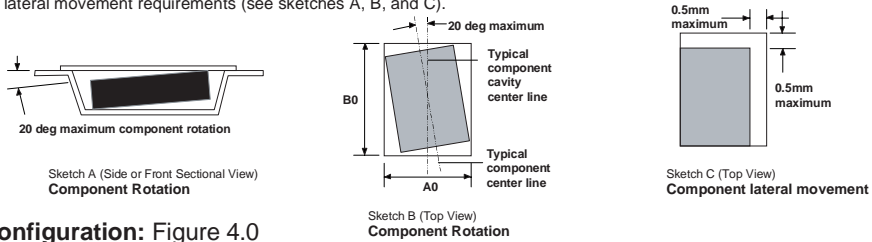

SC70-6 Reel Configuration: Figure 4.0

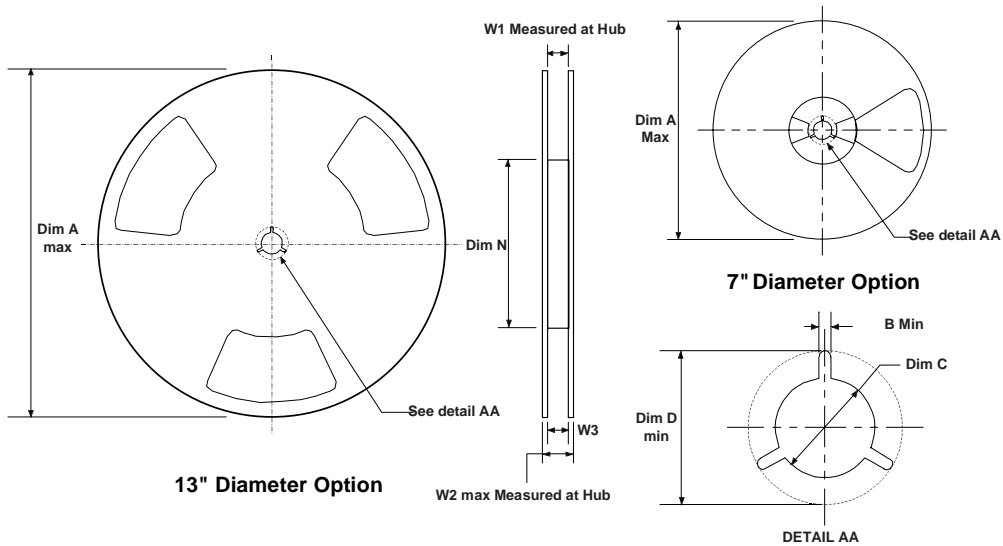

Dimensions are in inches and millimeters									
Tape Size	Reel Option	Dim A	Dim B	Dim C	Dim D	Dim N	Dim W1	Dim W2	Dim W3 (LSL-USL)
8mm	7" Dia	7.00 177.8	0.059 1.5	0.512 +0.020/-0.008 13 +0.5/-0.2	0.795 20.2	2.165 55	0.331 +0.059/-0.000 8.4 +1.5/0	0.567 14.4	0.311 - 0.429 7.9 - 10.9
8mm	13" Dia	13.00 330	0.059 1.5	0.512 +0.020/-0.008 13 +0.5/-0.2	0.795 20.2	4.00 100	0.331 +0.059/-0.000 8.4 +1.5/0	0.567 14.4	0.311 - 0.429 7.9 - 10.9

SC70-6 Tape and Reel Data and Package Dimensions, continued

SC70-6 (FS PKG Code 76)

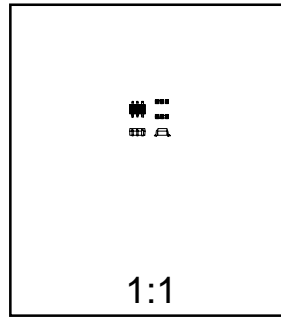
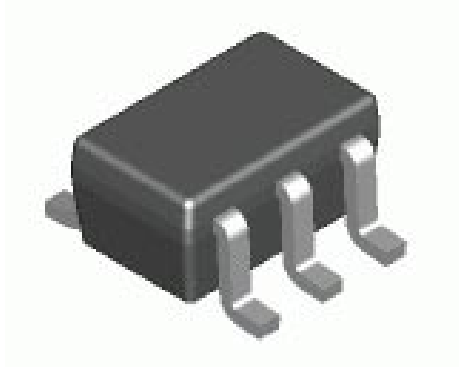

Scale 1:1 on letter size paper

Dimensions shown below are in:
inches [millimeters]

Part Weight per unit (gram): 0.0055

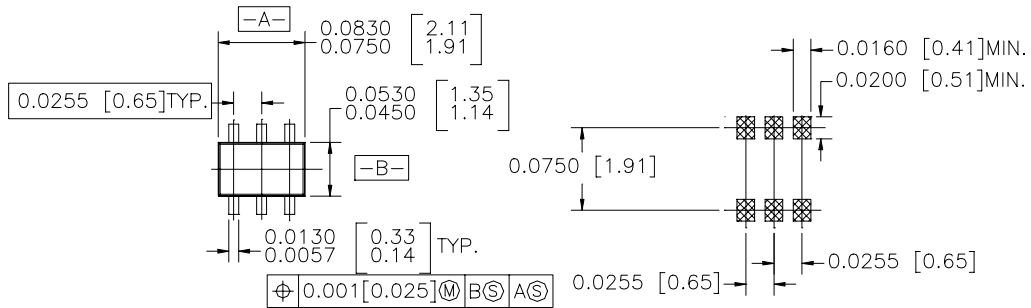

LAND PATTERN RECOMMENDATION

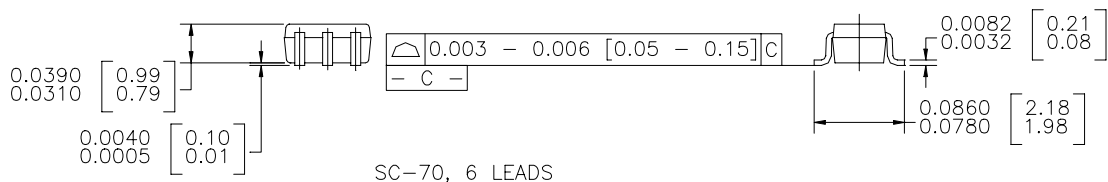

TRADEMARKS

The following are registered and unregistered trademarks Fairchild Semiconductor owns or is authorized to use and is not intended to be an exhaustive list of all such trademarks.

ACEx™	ISOPANAR™	TinyLogic™
CoolFET™	MICROWIRE™	UHC™
CROSSVOLT™	POP™	VCX™
E ² CMOS™	PowerTrench™	
FACT™	QFET™	
FACT Quiet Series™	QS™	
FAST®	Quiet Series™	
FASTr™	SuperSOT™-3	
GTO™	SuperSOT™-6	
HiSeC™	SuperSOT™-8	

DISCLAIMER

FAIRCHILD SEMICONDUCTOR RESERVES THE RIGHT TO MAKE CHANGES WITHOUT FURTHER NOTICE TO ANY PRODUCTS HEREIN TO IMPROVE RELIABILITY, FUNCTION OR DESIGN. FAIRCHILD DOES NOT ASSUME ANY LIABILITY ARISING OUT OF THE APPLICATION OR USE OF ANY PRODUCT OR CIRCUIT DESCRIBED HEREIN; NEITHER DOES IT CONVEY ANY LICENSE UNDER ITS PATENT RIGHTS, NOR THE RIGHTS OF OTHERS.

LIFE SUPPORT POLICY

FAIRCHILD'S PRODUCTS ARE NOT AUTHORIZED FOR USE AS CRITICAL COMPONENTS IN LIFE SUPPORT DEVICES OR SYSTEMS WITHOUT THE EXPRESS WRITTEN APPROVAL OF FAIRCHILD SEMICONDUCTOR CORPORATION. As used herein:

1. Life support devices or systems are devices or systems which, (a) are intended for surgical implant into the body, or (b) support or sustain life, or (c) whose failure to perform when properly used in accordance with instructions for use provided in the labeling, can be reasonably expected to result in significant injury to the user.
2. A critical component is any component of a life support device or system whose failure to perform can be reasonably expected to cause the failure of the life support device or system, or to affect its safety or effectiveness.

PRODUCT STATUS DEFINITIONS

Definition of Terms

Datasheet Identification	Product Status	Definition
Advance Information	Formative or In Design	This datasheet contains the design specifications for product development. Specifications may change in any manner without notice.
Preliminary	First Production	This datasheet contains preliminary data, and supplementary data will be published at a later date. Fairchild Semiconductor reserves the right to make changes at any time without notice in order to improve design.
No Identification Needed	Full Production	This datasheet contains final specifications. Fairchild Semiconductor reserves the right to make changes at any time without notice in order to improve design.
Obsolete	Not In Production	This datasheet contains specifications on a product that has been discontinued by Fairchild semiconductor. The datasheet is printed for reference information only.