



ULTRA HIGH VOLTAGE DUAL OPERATIONAL AMPLIFIER

103

M.S.KENNEDY CORP.

4707 Dey Road Liverpool, N.Y. 13088

(315) 701-6751

FEATURES:

- Low Cost Dual Amplifier
- Monolithic MOS Technology
- High Voltage Operation : 350V
- Low Quiescent Current : 2mA Max Per Amplifier
- High Output Current: 60mA Minimum Per Amplifier
- No Second Breakdown
- High Speed : 40V/ μ S Typ

MIL-PRF-38534 QUALIFIED

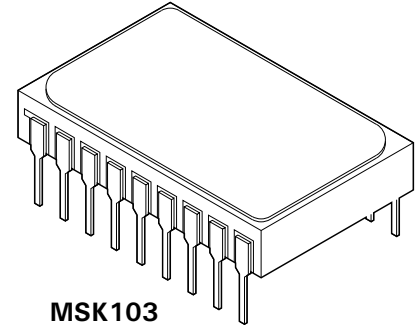

MSK103

DESCRIPTION:

The MSK 103 is an ultra high voltage monolithic MOSFET operational amplifier ideally suited for electrostatic transducer and electrostatic deflection applications. With a total supply voltage rating of 350 volts and 60mA of available output current available from each amplifier, the MSK 103 is also an excellent low cost choice for high voltage piezo drive circuits. The MOSFET output frees the MSK 103 from secondary breakdown limitations and power dissipation is kept to a minimum with a quiescent current rating of only 2mA per amplifier. The MSK 103 is packaged in a hermetically sealed 18 pin ceramic dip which has external compensation pins for each amplifier.

EQUIVALENT SCHEMATIC

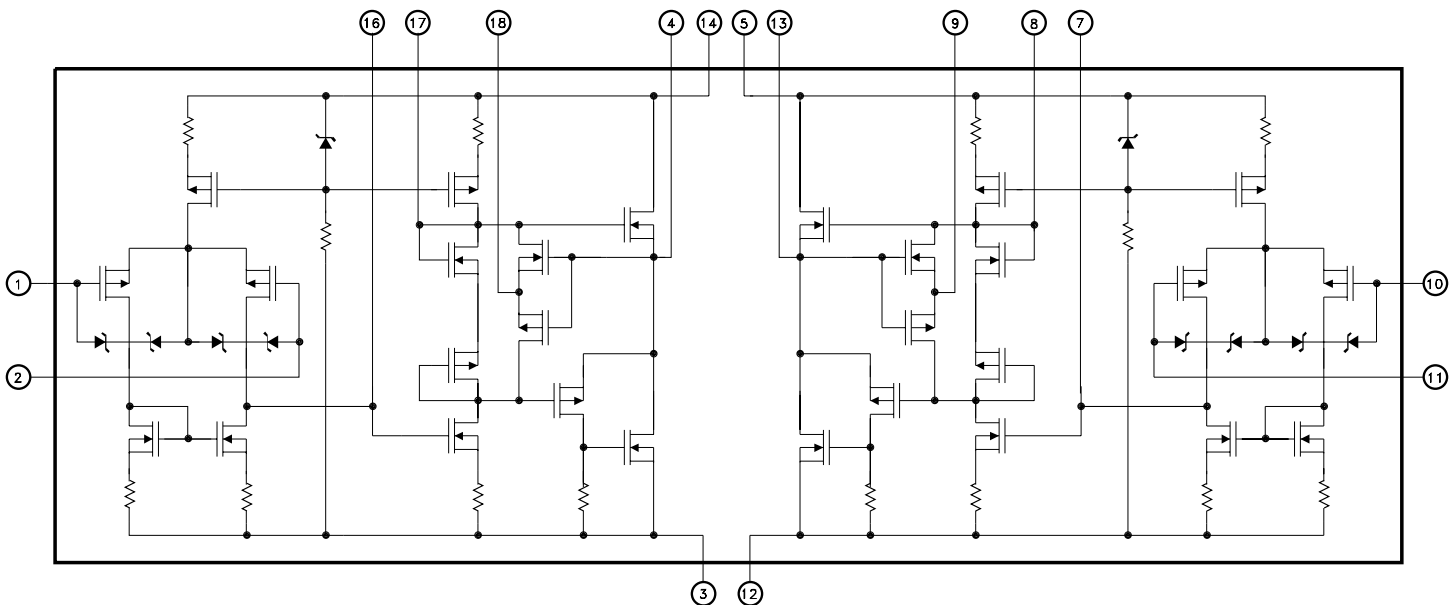

TYPICAL APPLICATIONS

- Piezo Electric Positioning
- Electrostatic Deflection
- Computer to Vacuum Tube Interface
- Ultra High Voltage Dual Op-Amp Applications
- 600 Volt, 0.12 Amp Bridge Amplifier

PIN-OUT INFORMATION

1 Inverting Input 1	18 Current Sense 1
2 Non Inverting Input 1	17 Comp 2-1 (U1)
3 -Vcc 1	16 Comp 1-1 (U1)
4 Output Drive 1	15 N/C
5 +Vcc 2	14 +Vcc 1
6 N/C	13 Output Drive 2
7 Comp 1-2 (U2)	12 -Vcc 2
8 Comp 2-2 (U2)	11 Non Inverting Input 2
9 Current Sense 2	10 Inverting Input 2

ABSOLUTE MAXIMUM RATINGS

V_{CC} ②	Total Supply Voltage	350V	T_{ST}	Storage Temperature	-65°C to +150°C
$\pm I_{OUT}$	Output Current (within S.O.A.)	60mA	T_{LD}	Lead Temperature	300°C
$\pm I_{OUTP}$	Output Current Peak	120mA	T_C	Case Operating Temperature (MSK103B)	-55°C to +125°C
V_{IND}	Input Voltage (Differential)	$\pm 16V$		(MSK103)	-40°C to +85°C
V_{IN}	Input Voltage (Common Mode)	$\pm V_{CC}$	R_{TH}	Thermal Resistance (DC Each Amp) Junction to Case	11°C/W
T_J	Junction Temperature	150°C			

ELECTRICAL SPECIFICATIONS

Parameter	Test Conditions ①	Group A Subgroup	MSK103B			MSK103			Units
			Min.	Typ.	Max.	Min.	Typ.	Max.	
STATIC									
Supply Voltage Range ② ④ ⑨		-	± 50	± 150	± 175	± 50	± 150	± 175	V
Quiescent Current	$V_{IN} = 0V$	1	-	± 1.4	± 2.0	-	± 1.4	± 2.0	mA
		2	-	± 2.0	± 3.0	-	-	-	mA
		3	-	± 1.0	± 2.1	-	-	-	mA
INPUT									
Offset Voltage	$V_{IN} = 0V$	1	-	± 15	± 30	-	± 15	± 30	mV
Offset Voltage Drift ④	$V_{IN} = 0V$	2,3	-	± 40	± 65	-	± 40	-	$\mu V/^\circ C$
Offset Voltage vs $\pm V_{CC}$ ④	$V_{IN} = 0V$	1	-	± 20	± 32	-	± 20	± 32	$\mu V/V$
Input Bias Current ④	$V_{CM} = 0V$	1,3	-	± 5	± 50	-	± 5	± 100	pA
		2	-	-	± 50	-	-	-	nA
Input Impedance ④	(DC)	-	-	10^{11}	-	-	10^{11}	-	Ω
Input Capacitance ④		-	-	5	-	-	5	-	pF
Common Mode Rejection ④	$V_{CM} = \pm 90VDC$	-	84	94	-	84	94	-	dB
Noise	$1Hz \leq f \leq 10Hz$	-	-	50	-	-	50	-	$\mu VRMS$
OUTPUT									
Output Voltage Swing	$I_{OUT} = \pm 40mA$ Peak	4	± 138	± 141	-	± 138	± 141	-	V
Output Current	$V_{OUT} = MAX$	4	± 60	± 120	-	± 60	± 120	-	mA
Power Bandwidth ④	$C_C = 10pF$ $V_{OUT} = 280V_{PP}$	-	-	26	-	-	26	-	KHz
Resistance ④	No Load $R_{CL} = 0\Omega$	-	-	150	-	-	150	-	Ω
Settling Time to 0.1% ③ ④	$C_C = 10pF$ 10V Step	-	-	12	-	-	12	-	μS
Capacitive Load ④	$A_V = +1V/V$	-	10	-	-	10	-	-	nF
TRANSFER CHARACTERISTICS									
Slew Rate	$C_C = Open$	4	20	40	-	20	40	-	$V/\mu S$
Open Loop Voltage Gain ④	$F = 15Hz$ $R_L = 5K\Omega$	4	94	106	-	94	106	-	dB

NOTES:

- ① Unless otherwise noted $C_C = 18pF$, $R_C = 2.2K\Omega$, $\pm V_{CC} = \pm 150VDC$ and specifications apply to each amplifier.
- ② Derate maximum supply voltage 0.5V/°C below $T_C = +25^\circ C$. No derating is needed above $T_C = 25^\circ C$.
- ③ $A_V = -10V/V$ measured in false summing junction circuit.
- ④ Devices shall be capable of meeting the parameter, but need not be tested. Typical parameters are for reference only.
- ⑤ Industrial grade devices shall be tested to subgroups 1 and 4 unless otherwise requested.
- ⑥ Military grade devices ('B' suffix) shall be 100% tested to subgroups 1,2,3 and 4.
- ⑦ Subgroup 5 and 6 testing available upon request.
- ⑧ Subgroup 1,4 $T_C = +25^\circ C$
Subgroup 2,5 $T_C = +125^\circ C$
Subgroup 3,6 $T_A = -55^\circ C$
- ⑨ Electrical specifications are derated for power supply voltages less than $\pm 50VDC$.

APPLICATION NOTES

CURRENT LIMIT

Current limit resistor value can be calculated as follows:

$$R_{CL} = 3/I_{LIM}$$

It is recommended that the user set up the value of current limit as close as possible to the maximum expected output current to protect the amplifier. The minimum value of current limit resistance is 33 ohms. The maximum practical value is 500 ohms. Current limit will vary with case temperature. Refer to the typical performance graphs as a guide. Since load current passes through the current limit resistor, a loss in output voltage swing will occur. The following formula approximates output voltage swing reduction:

$$V_R = I_O * R_{CL}$$

When the device is in current limit, there will be spurious oscillations present on the negative half cycle. The frequency of the oscillation is application dependant and can not be predicted. Oscillation will cease when the device comes out of current limit. If current limit is not required simply short pin 4 to pin 18 and pin 9 to pin 13.

INPUT PROTECTION

Input protection circuitry within the MSK 103 will clip differential input voltages greater than 16 volts. The inputs are also protected against common mode voltages up to the supply rails as well as static discharge. There are 300 ohm current limiting resistors in series with each input. These resistors may become damaged in the event the input overload is capable of driving currents above 1mA. If severe overload conditions are expected, external input current limiting resistors are recommended.

OUTPUT SNUBBER NETWORK

A 100 ohm resistor and a 330pF capacitor connected in series from the output of the amplifier to ground is recommended for applications where load capacitance is less than 330pF. For larger values of load capacitance, the output snubber network may be omitted. If loop stability becomes a problem due to excessively high load capacitance, a 100 ohm resistor may be added between the output drive pin of the amplifier and the load. A small tradeoff with bandwidth must be made in this configuration. The graph below illustrates the effect of capacitive load on open loop gain.

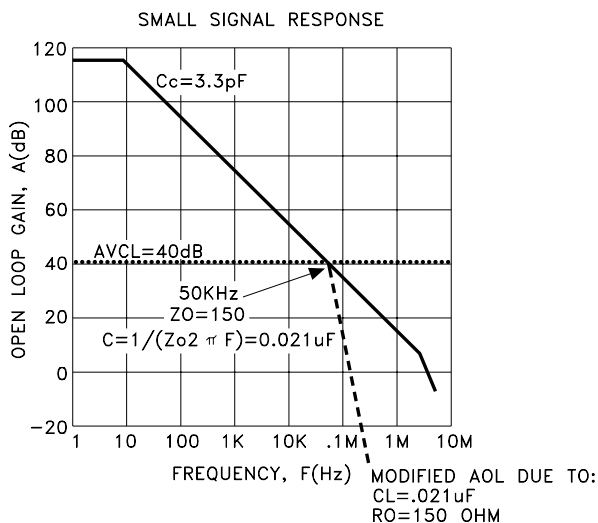

SAFE OPERATING AREA (SOA)

The MOSFET output stage of this power operational amplifier has two distinct limitations:

1. The current handling capability of the die metallization.
2. The junction temperature of the output MOSFET's.

NOTE: The output stage is protected against transient flyback. However, for protection against sustained, high energy flyback, external fast-recovery reverse biased diodes should be connected from the output to ground.

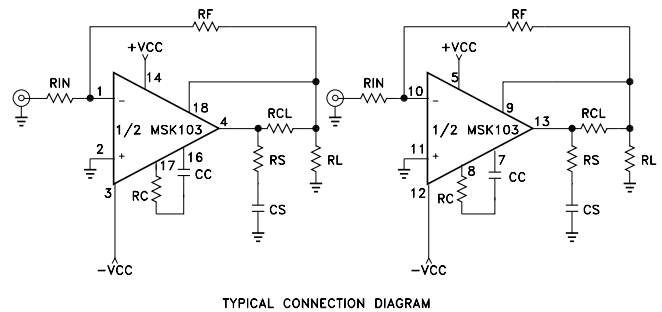
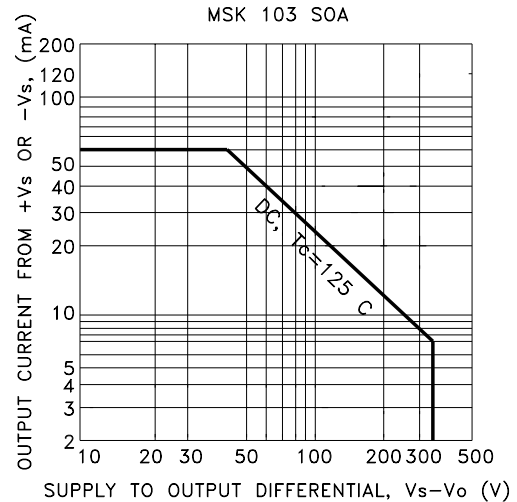

STABILITY

The MSK 103 has sufficient phase margin when compensated for unity gain to be stable with capacitive loads of at least 10nF. However, it is recommended that the parallel sum of the input and feedback resistor be 1000 ohms or less for closed loop gains of ten or less to minimize phase shift caused by the R-C network formed by the input resistor, feedback resistor and input capacitance. The user can tailor the performance of the MSK 103 to their application using the external compensation pins. The graphs of small signal gain and phase as well as the graphs of slew rate and power response demonstrate the effect of various forms of compensation. The compensation capacitor must be rated at 350 volts working voltage if maximum power supply voltages are used. The compensation resistor and capacitor lead lengths must be kept as short as possible to minimize spurious oscillations. A high quality NPO capacitor is recommended for the compensation capacitor.

EXTERNAL COMPENSATION

External compensation is only necessary at gains of 30v/v or less. For larger gains, the compensation resistor and capacitor may be omitted. An effective method of checking amplifier stability is to apply the worst case capacitive load to the output of the amplifier and drive a small signal square wave across it. If overshoot is less than 25%, the system will typically be stable.

TYPICAL PERFORMANCE CURVES

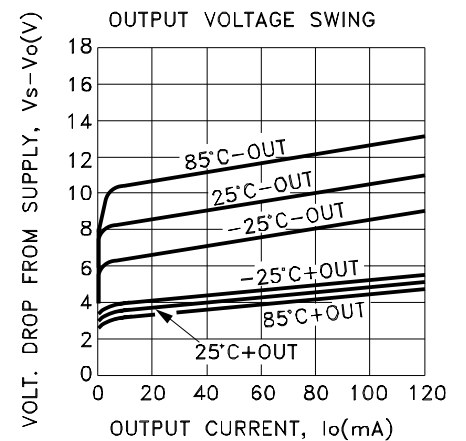
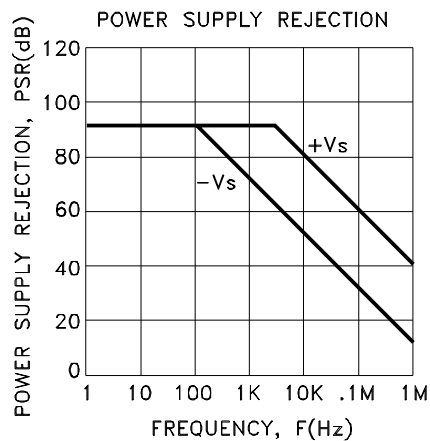
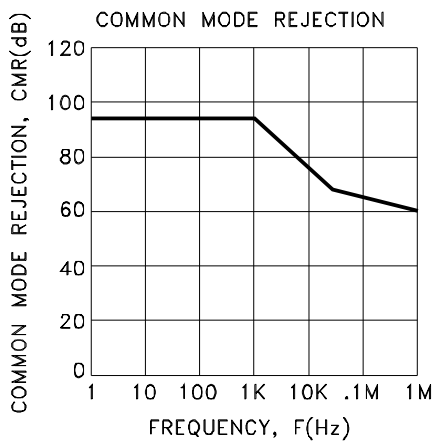
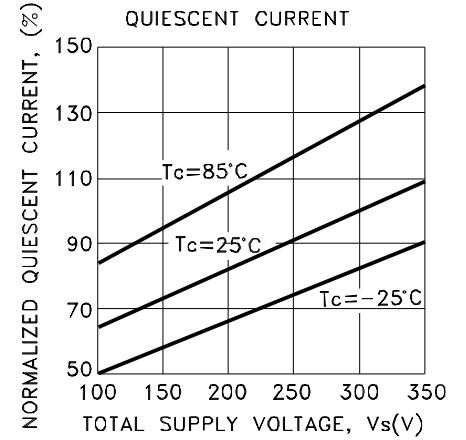
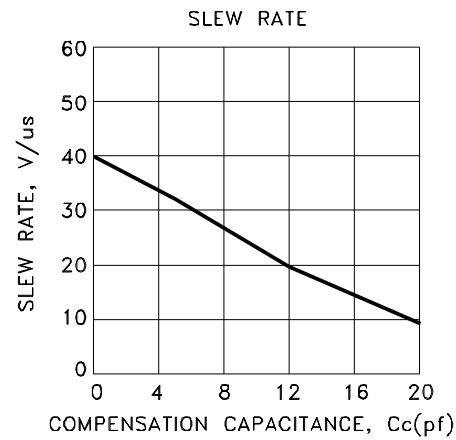
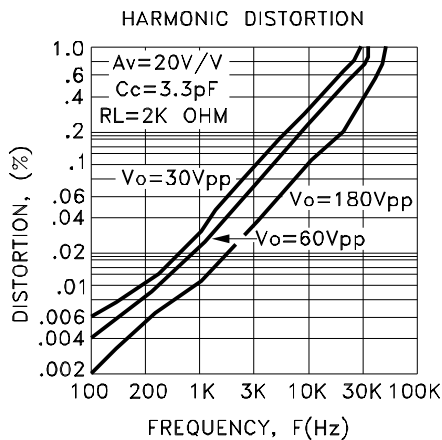
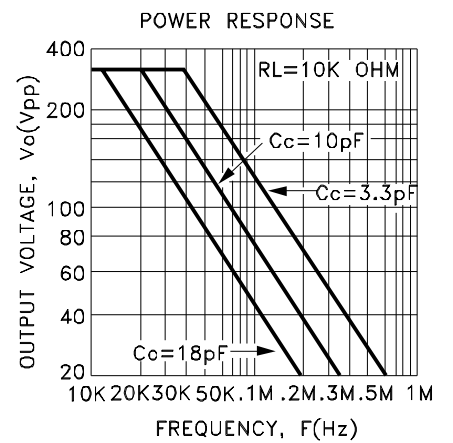
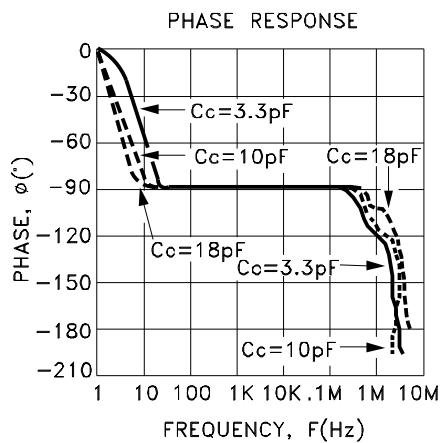
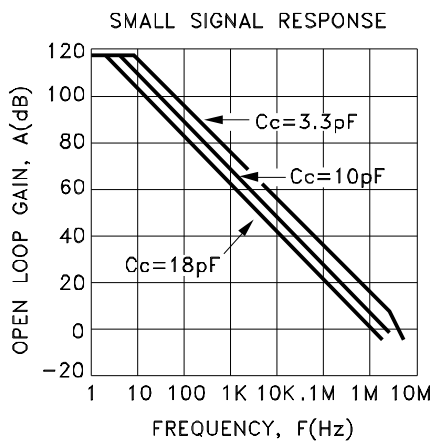
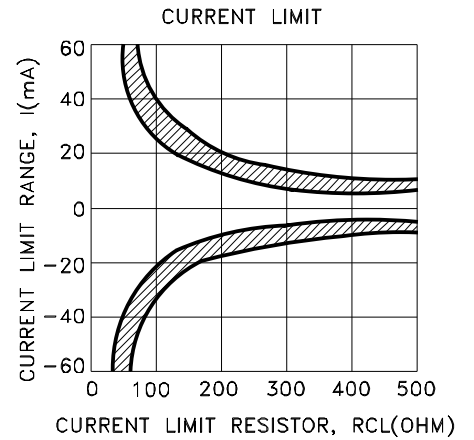
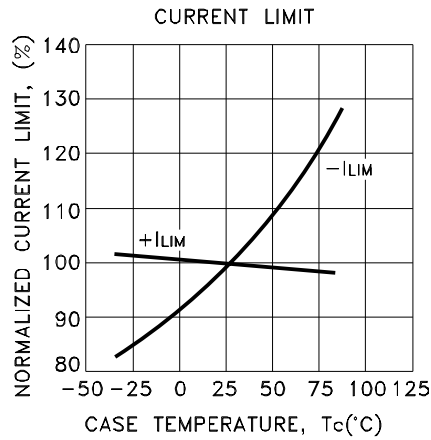
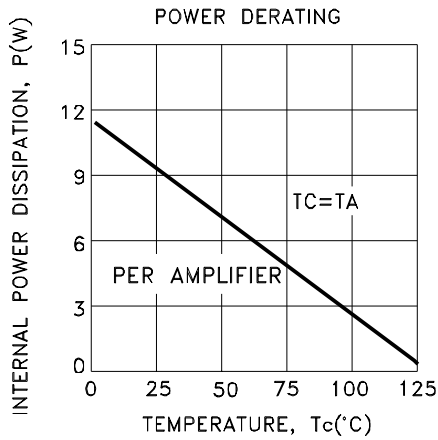

MECHANICAL SPECIFICATIONS

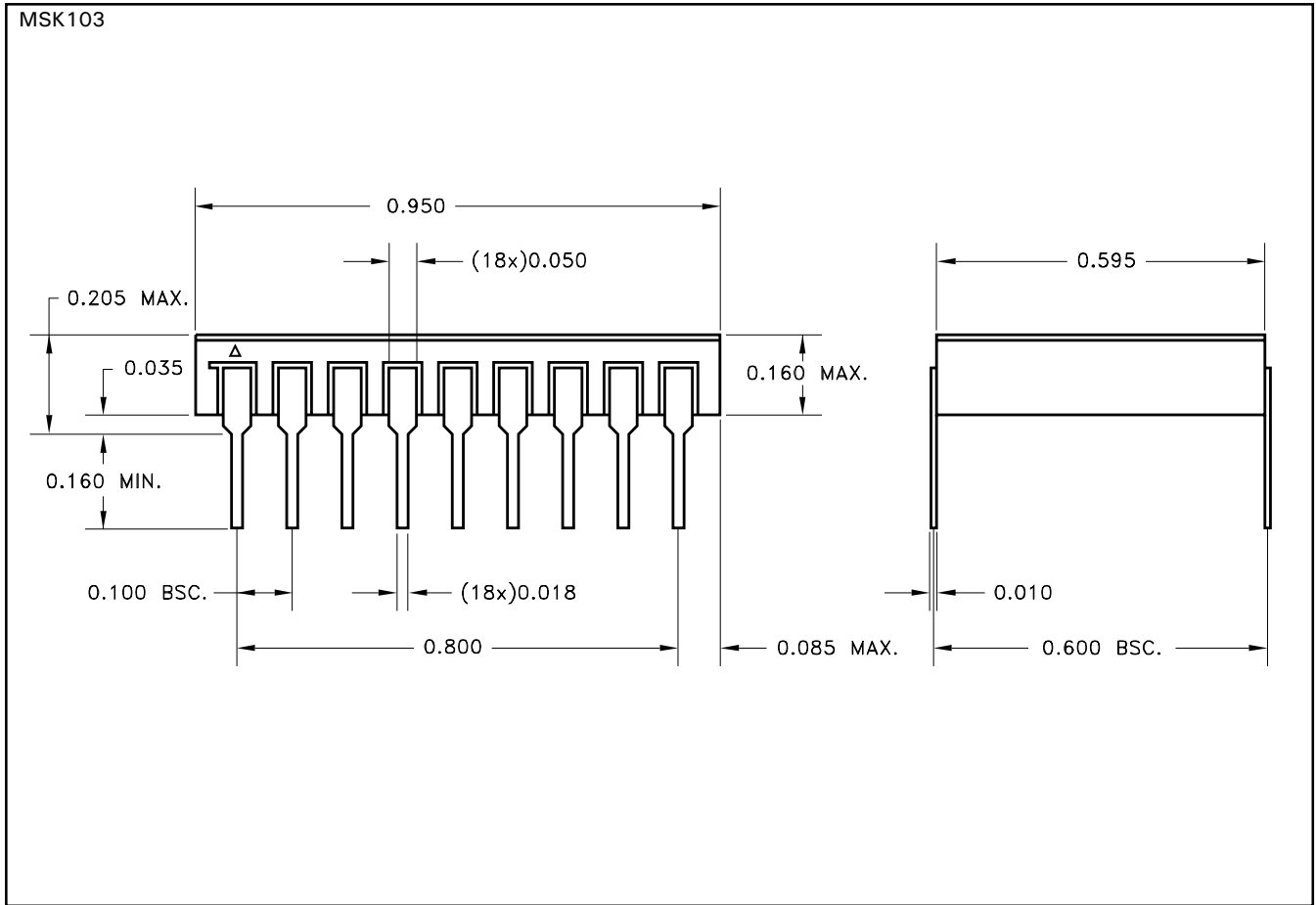

ESD TRIANGLE INDICATES PIN 1.
ALL DIMENSIONS ARE ± 0.010 INCHES UNLESS OTHERWISE LABELED.

ORDERING INFORMATION

Part Number	Screening Level
MSK103	Industrial
MSK103B	Military-Mil-PRF-38534

M.S. Kennedy Corp.
4707 Dey Road, Liverpool, New York 13088
Phone (315) 701-6751
FAX (315) 701-6752
www.mskennedy.com

The information contained herein is believed to be accurate at the time of printing. MSK reserves the right to make changes to its products or specifications without notice, however, and assumes no liability for the use of its products.