

NAIS

15A (2C), 10A (4C) COMPACT POWER RELAYS WITH HIGH SENSITIVITY

SP RELAYS

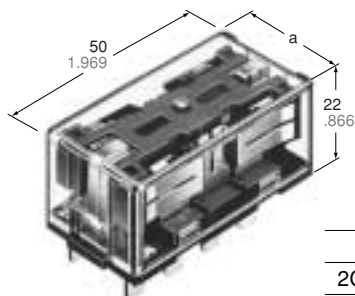

mm inch

	a
2C	25.6 1.008
4C	36.8 1.449

FEATURES

- **High Vibration/Shock Resistance**
Vibration resistance: 18 G, amplitude 3 mm (10 to 55 Hz)
Shock resistance: 40 G (11 ms)
- **Latching types available**
- **High Sensitivity in Small Size 150 mW pick-up, 300 mW nominal operating power**
- **Wide Switching Range**
From 1 mA to 15 A (2C) and 10 A (4C)

SPECIFICATIONS

Contacts

Arrangement	2 Form C, 4 Form C		
Initial contact resistance, max. (By voltage drop 6 V DC 1 A)	30 mΩ		
Initial contact pressure	2C: Approx. 0.392 N (40 g 1.41 oz) 4C: Approx. 0.196 N (20 g 0.71 oz)		
Contact material	Stationary contact: Gold flashed silver alloy		
	Movable contact: Silver alloy		
Rating (resistive load)	Nominal switching capacity	2C: 15 A 250 V AC 10 A 30 V DC 4C: 10 A 250 V AC 10 A 30 V DC	
	Max. switching power	2C: 3,750 VA, 300 W 4C: 2,500 VA, 300 W	
	Max. switching voltage	2C, 4C: 250 V AC, 30 V DC	
	Max. switching current	2C: 15 A (AC) 10 A (DC), 4C: 10 A	
Expected life (min. operations)	Mechanical (at 180 cpm)	5 × 10 ⁷	
	Electrical (at 20 cpm) (resistive load)	2C	15 A 250 V AC 10 A 30 V DC
		4C	10 A 250 V AC 10 A 30 V DC
			10 ⁵
			10 ⁵

Coil (polarized) at 20°C 68°F

Single side stable	Nominal operating power	300 mW
	Minimum set and reset power	150 mW
Latching	Nominal set and reset power	300 mW

Characteristics (at 25°C 77°F 50% Relative humidity)

Max. operating speed (at rated load)		20 cpm
Initial insulation resistance*1		1,000 MΩ at 500 V DC
Initial breakdown voltage*2	Between open contacts	1,500 Vrms
	Between contact sets	3,000 Vrms
	Between contact and coil	3,000 Vrms
Operate time*3(at nominal voltage)		Max. 30 ms (Approx. 25 ms)
Release time(without diode)*3 (at nominal voltage)		Max. 20 ms (Approx. 15 ms)
Temperature rise (at nominal voltage)		Max. 40°C with nominal coil voltage and at nominal switching capacity
Shock resistance	Functional*4	Min. 392 m/s ² {40 G}
	Destructive*5	Min. 980 m/s ² {100 G}
Vibration resistance	Functional*6	176.4 m/s ² {18 G}, 10 to 55 Hz at double amplitude of 3 mm
	Destructive	176.4 m/s ² {18 G}, 10 to 55 Hz at double amplitude of 3 mm
Conditions for operation, transport and storage*7 (Not freezing and condensing at low temperature)	Ambient temp.	-50°C to +60°C -58°F to +140°F
	Humidity	5 to 85% R.H.
Unit weight		2C: 50 g 1.76 oz ; 4C: 65 g 2.29 oz

Remarks

- * Specifications will vary with foreign standards certification ratings.
- *1 Measurement at same location as "Initial breakdown voltage" section
- *2 Detection current: 10 mA
- *3 Excluding contact bounce time
- *4 Half-wave pulse of sine wave: 11ms; detection time: 10μs
- *5 Half-wave pulse of sine wave: 6ms
- *6 Detection time: 10μs
- *7 Refer to 6. Conditions for operation, transport and storage mentioned in AMBIENT ENVIRONMENT.

TYPICAL APPLICATIONS ORDERING INFORMATION

NC machines, remote control panels, sophisticated business equipment.

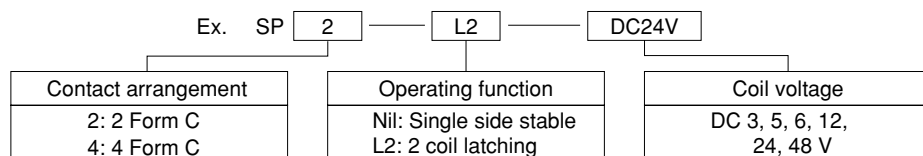

- (Notes) 1. PC board terminal types available as option. Please consult us for details.
2. 2 Form C: Carton: 20 pcs., Case: 200 pcs.
4 Form C: Carton: 10 pcs., Case: 100 pcs.
3. UL/CSA, TÜV approved type is standard.
4. 1 coil latching type available.

SP

TYPES AND COIL DATA (at 20°C 68°F)

Single side stable

Part No.		Nominal voltage, V DC	Pick-up voltage, V DC (max.)	Drop-out voltage, V DC (min.)	Nominal operating current, mA	Coil resistance, Ω (±10%) 20°C	Inductance, H (at 120 Hz)	Nominal operating power, mW	Maximum allowable voltage, V DC (40°C)
2 Form C	4 Form C								
SP2-DC3V	SP4-DC3V	3	2.1	0.3	100.0	30	Approx. 0.05	300	4.5
SP2-DC5V	SP4-DC5V	5	3.5	0.5	60.2	83	0.1	300	7.5
SP2-DC6V	SP4-DC6V	6	4.2	0.6	50.0	120	0.2	300	9
SP2-DC12V	SP4-DC12V	12	8.4	1.2	25.0	480	0.7	300	18
SP2-DC24V	SP4-DC24V	24	16.8	2.4	12.5	1,920	3.0	300	36
SP2-DC48V	SP4-DC48V	48	33.6	4.8	6.2	7,700	11.2	300	72

2-coil latching

Part No.		Nominal voltage, V DC	Set and reset voltage, V DC (max.)	Nominal operating current, mA	Coil resistance, Ω (±10%)		Inductance, H (at 120 Hz)		Nominal operating power, mW	Maximum allowable voltage, V DC (40°C)
2 Form C	4 Form C				Coil I	Coil II	Coil I	Coil II		
SP2-L2-DC3V	SP4-L2-DC3V	3	2.1	100.0	30	30	Approx. 0.03	Approx. 0.03	300	4.5
SP2-L2-DC5V	SP4-L2-DC5V	5	3.5	60.2	83	83	0.07	0.07	300	7.5
SP2-L2-DC6V	SP4-L2-DC6V	6	4.2	50.0	120	120	0.1	0.1	300	9
SP2-L2-DC12V	SP4-L2-DC12V	12	8.4	25.0	480	480	0.4	0.4	300	18
SP2-L2-DC24V	SP4-L2-DC24V	24	16.8	12.5	1,920	1,920	1.4	1.4	300	36
SP2-L2-DC48V	SP4-L2-DC48V	48	33.6	6.2	7,680	7,680	5.6	5.6	300	72

DIMENSIONS

mm inch

2 Form C

Plug-in terminal

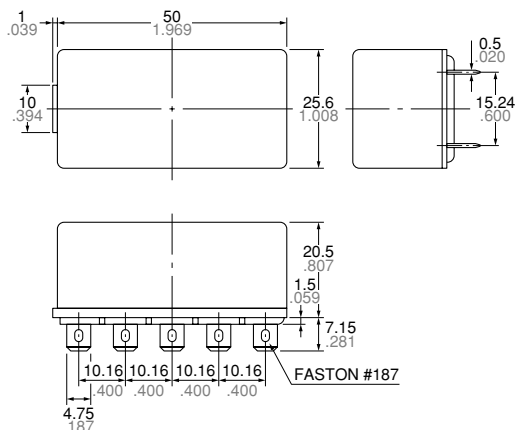

General tolerance: $\pm 0.3 \pm 0.012$

Schematic (Bottom view)

Single side stable



(Deenergized condition)

2 coil latching

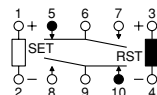

(Reset condition)

Diagram shows the "reset" position when terminals 3 and 4 are energized. Energize terminals 1 and 2 to transfer contacts.

4 Form C

Plug-in terminal

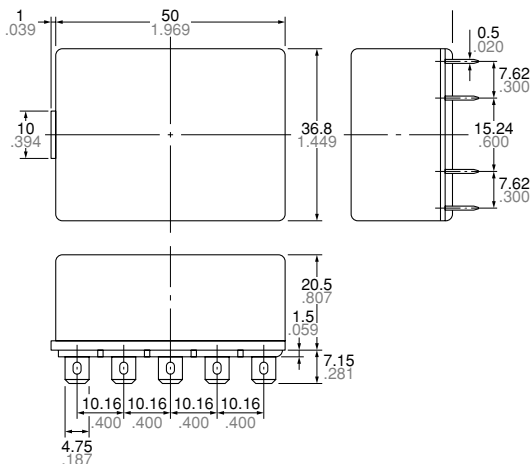

General tolerance: $\pm 0.3 \pm 0.012$

Schematic (Bottom view)

Single side stable

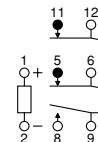

(Deenergized condition)

2 coil latching

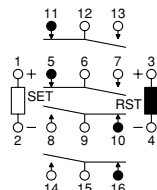

(Reset condition)

Diagram shows the "reset" position when terminals 3 and 4 are energized. Energize terminals 1 and 2 to transfer contacts.

REFERENCE DATA

Operate and release time (Single side stable)
SP2

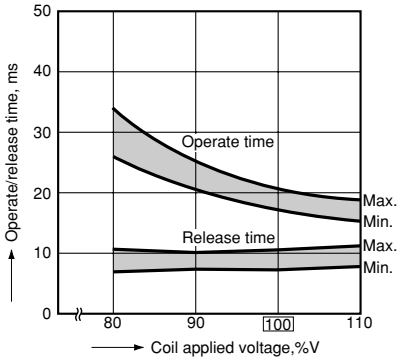

SP4

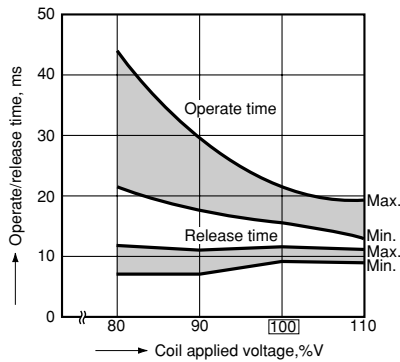

Coil temperature rise
Sample: SP2-DC24V
Ambient temperature: 20 to 22°C 68 to 72°F

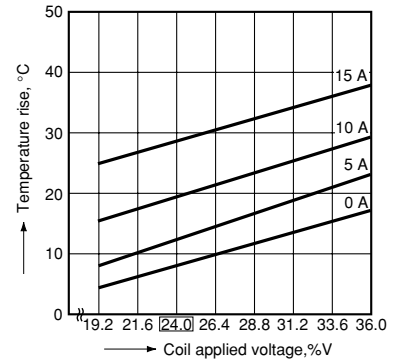

Sample: SP4-DC24V
Ambient temperature: 27 to 29°C 81 to 84°F

Electrical life (SP2, 15 A 250 V AC resistive load)

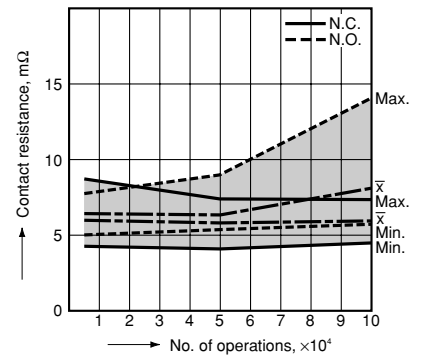
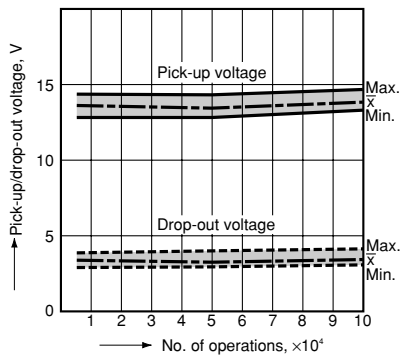
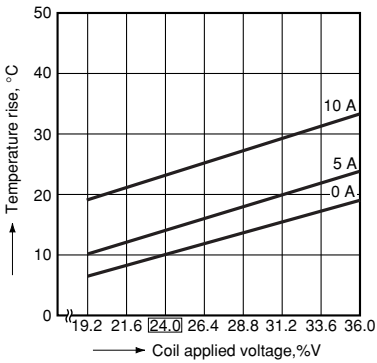

Electrical life (SP4, 10 A 250 V AC resistive load)

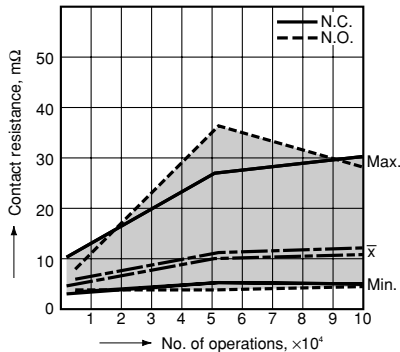
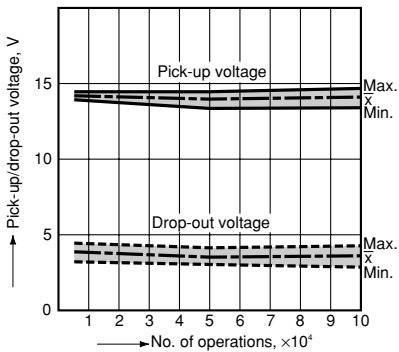

Soldering socket
SP2-SS

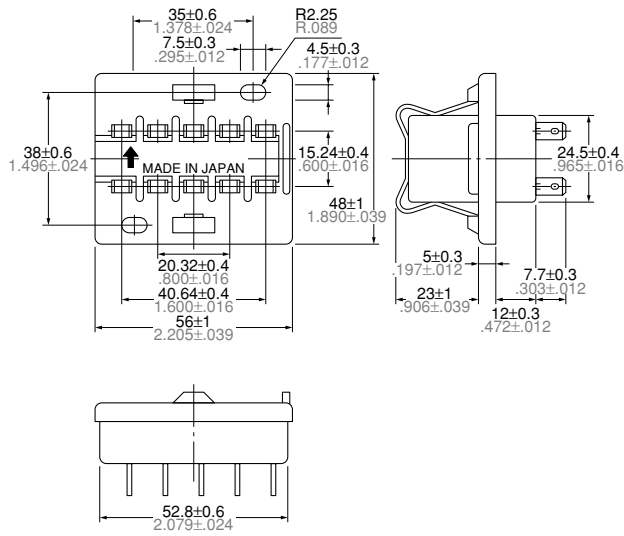

SP4-SS

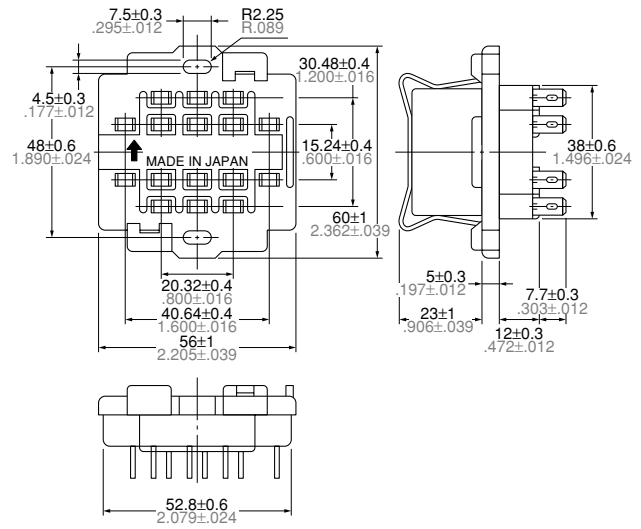

Wrapping socket
SP2-WS

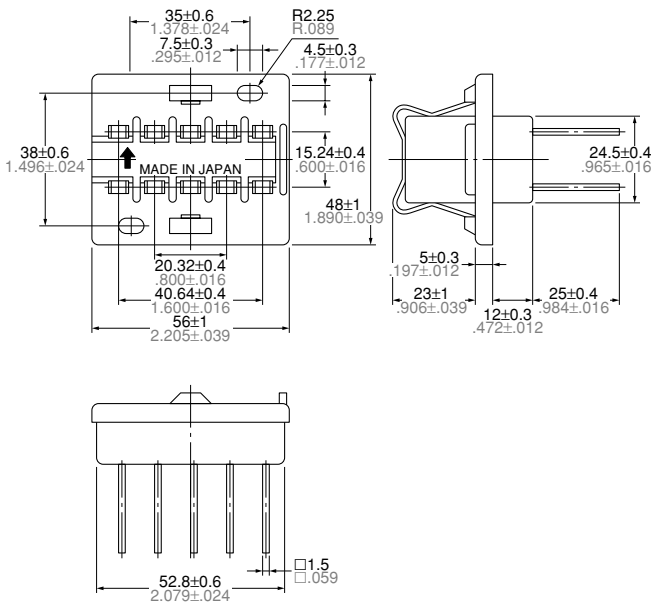

SP4-WS

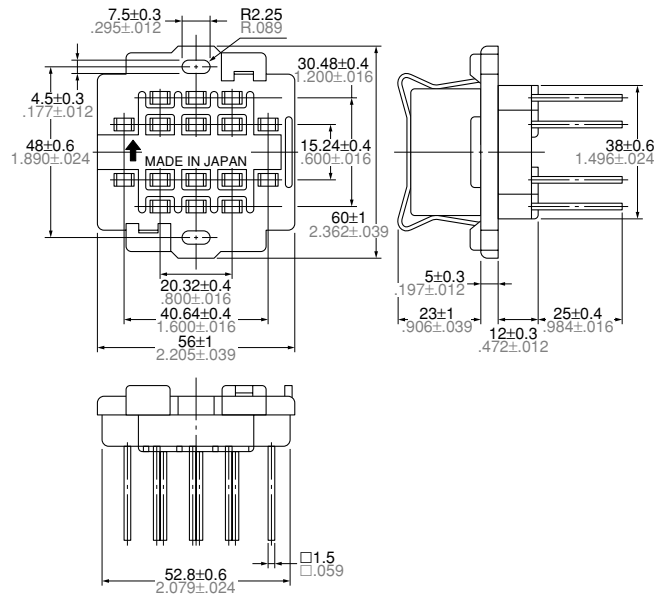

Mounting hole drilling diagram

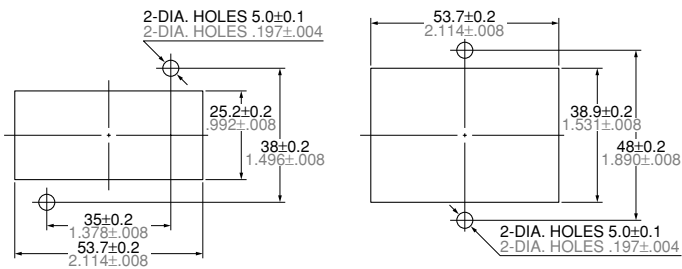

Performance profile

Item	SP2, socket with solder	SP4, socket with solder	SP2, wrapping socket	SP4, wrapping socket
Withstand voltage	AC 3,000V, 1 min., between each terminal			
Insulation resistance	1,000 MΩ min			
Ambient working temperature	-50 to +60°C -58 to +140°F			
Maximum current, ON current	15 A	10 A	12 A	10 A

Note: Do not remove the relay while it is ON.

Notes:

- (1) Mounting screws and the fastening bracket are included in the package.
- (2) Mount the relay with the proper mounting direction — i.e. with the direction of the NAIS mark on top of the relay case match-

ing the direction of the NAIS mark on the terminal block. (The  direction of the terminal block is the upward direction of the relay.)

Mounting and removal of fastening bracket

1. Mounting

Insert the A part of the fastening bracket into the mounting groove of the socket, and then fit the B part into groove, while pressing with the tip of a minus screwdriver.

2. Removal

Slide the B part of the fastening bracket

from the groove in the socket, while pressing with the tip of a minus screwdriver. While the bracket is in this position, keep pressing the C part of the bracket to the relay side with your finger, and lift up to the left side and remove from the groove, as in the diagram at right.

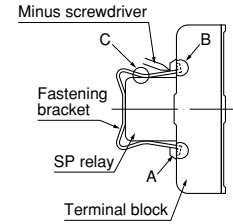

Screw terminal socket

mm inc

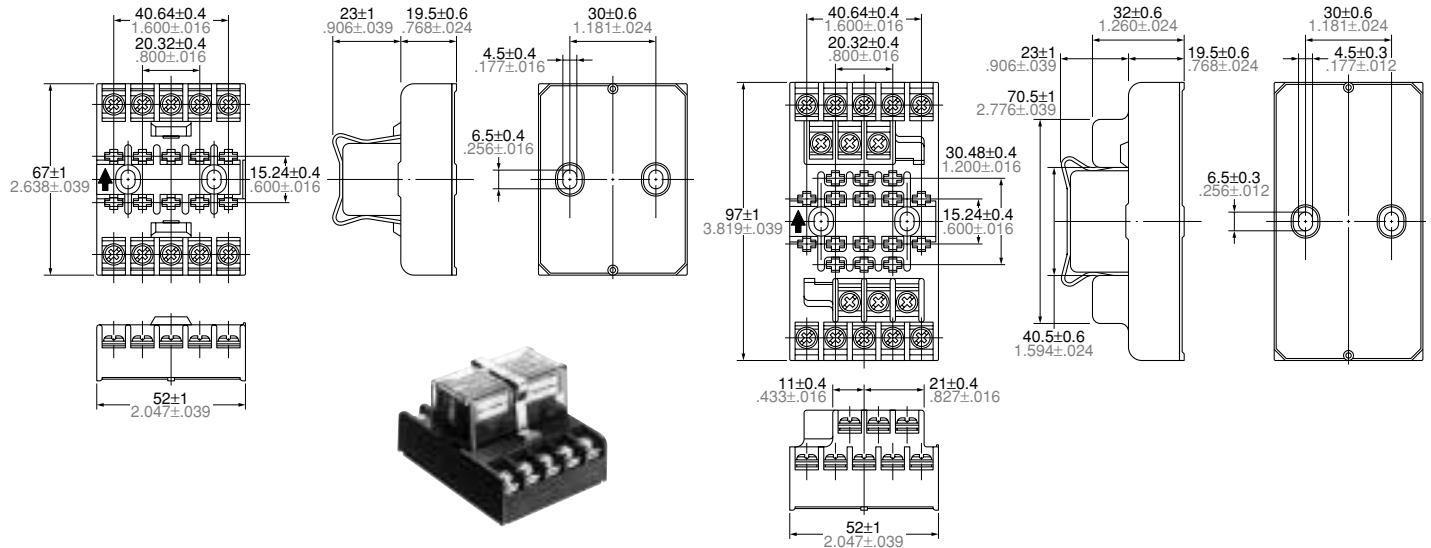

Mounting hole drilling diagram

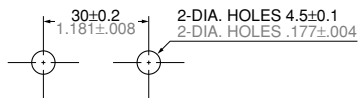

Notes:

- (1) Mounting screws and the fastening bracket are included in the package.
- (2) Mount the relay with the proper mounting direction — i.e. with the direction of the NAIS mark on top of the relay case matching the direction of the NAIS mark on the terminal block. (The ↑ direction of the terminal block is the upward direction of the relay.)

Fastening bracket mounting and removal

1. Mounting

Insert the A part of the fastening bracket into the mounting groove of the terminal block, and then fit the B part into groove, while pressing with the tip of a minus screwdriver.

2. Removal

Slide the B part of the fastening bracket from the groove in the terminal block, while pressing with the tip of a minus screwdriver. While the bracket is in this position, keep pressing the C part of the bracket to the relay side with your finger,

and lift up to the left side and remove from the groove, as in the diagram at right.

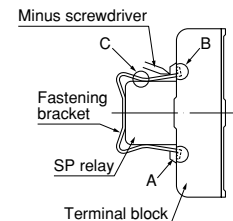

Mounting plate

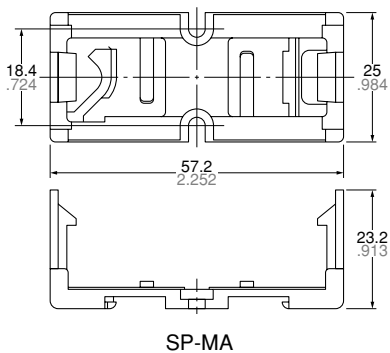

The SP-Relay with SP-MA attached

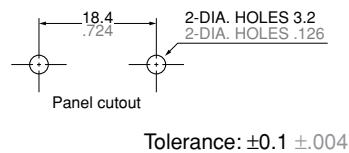

Direct chassis mounting possible, and applicable to DIN rail. [DIN 46277 (35 mm width) is applicable.]

Use method

- Both the SP relay 2c and 4c can be mounted to the mounting slats.
- Use the mounting slats either by attaching them directly to the chassis, or by mounting with a DIN rail.

(A) When attaching directly to chassis
Use two M3 screws.

For the mounting pitch, refer to the specification diagram.

(B) When mounting on a DIN rail

Use a 35mm 1.378inch wide DIN rail (DIN46277).

The mounting method should be as indicated in the diagram at right.

Method for mounting on DIN rail

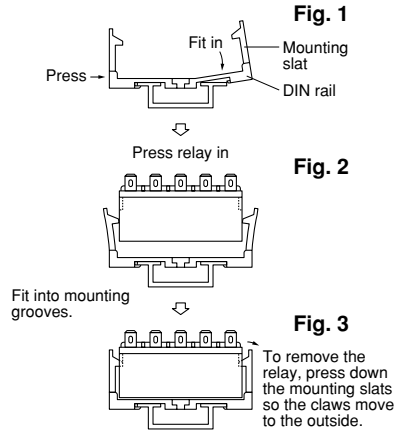

- First fit the arc shaped claw of the mounting slat into the DIN rail.
- Press on the side as shown in the diagram below.
- Fit in the claw part on the opposite side.

Precautions for use

When mounting to a DIN rail, use a commercially available fastening bracket if there is a need to stop sliding of the mounting slat in the rail direction.

For Cautions for Use, see Relay Technical Information.