

Photologic[®] Optical Flag Switch

Types OPB685, OPB686, OPB687, OPB688

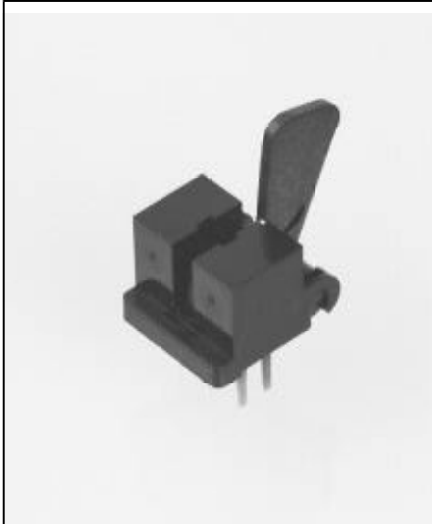

Features

- Photologic[®] output
- Four output options
- Mechanical switch replacement
- Printed circuit board mounting

Description

The OPB685 series flag switches consist of an infrared emitting diode and a monolithic integrated circuit, which incorporates a photodiode, a linear amplifier and a Schmitt trigger. A lever arm actuated flag interrupts the light beam switching the output between states that can readily drive logic gates.

Customized lever arms and spring torques can be designed for specific applications.

The device features TTL/LSTTL compatible logic level output which can drive up to 10 TTL loads over a voltage range from 4.5 V to 16 V.

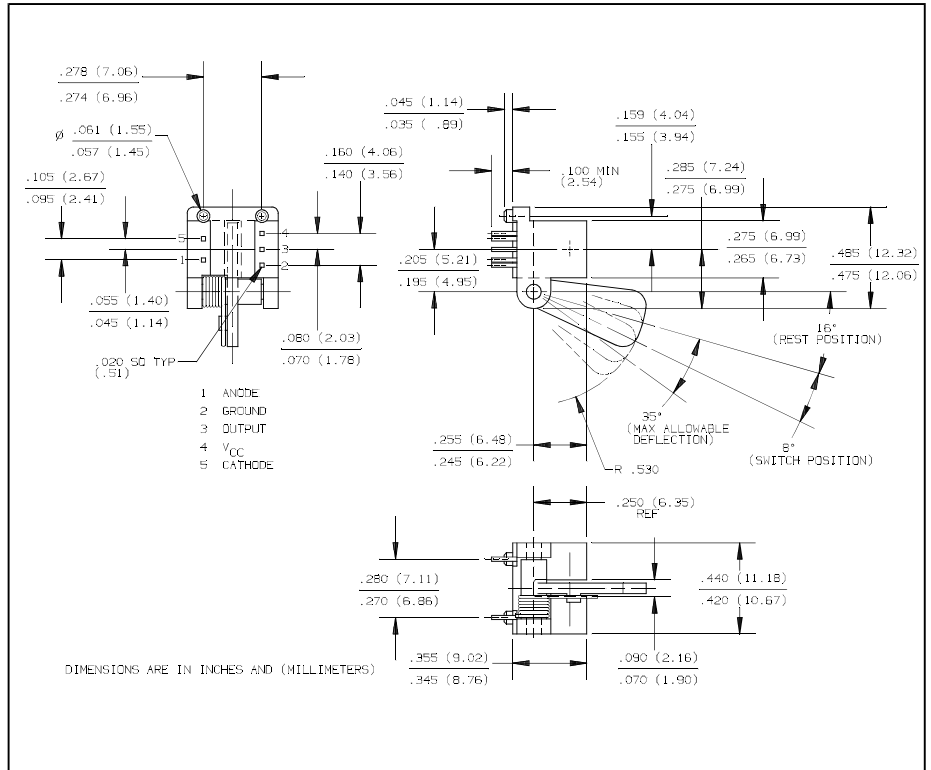

Absolute Maximum Ratings (T_A = 25^o C unless otherwise noted)

Storage Temperature Range	-40 ^o C to +100 ^o C
Operating Temperature Range	-40 ^o C to +100 ^o C
Lead Soldering Temperature [1/16 inch (1.6 mm) from case for 5 sec. with soldering iron]	240 ^o C

Input Diode

Forward DC Current	50 mA
Peak Forward Current (1μs pulse width, 300 pps)	3.0 A
Reverse DC Voltage	3.0 V
Power Dissipation	100 mW ⁽²⁾

Output Photologic[®]

Supply Voltage, V _{CC}	18 V
Duration of Output Short To V _{CC}	1.00 sec
Voltage at Output	30 V
Low Level Output Current (sinking)	16 mA
Power Dissipation	240 mW ⁽³⁾

Notes:

- (1) RMA flux is recommended. Duration can be extended to 10 sec. max. when flow soldering.
- (2) Derate linearly 1.33 mW/^o C above 25^o C.
- (3) Derate linearly 2.50 mW/^o C above 30^o C.

Types OPB685, OPB686, OPB687, OPB688

Electrical Characteristics (T_A = 25° C unless otherwise noted)

SYMBOL	PARAMETER	MIN	TYP	MAX	UNITS	TEST CONDITIONS
Input Diode						
V _F	Forward Voltage			1.6	V	I _F = 10 mA
I _R	Reverse Current			100	μA	V _R = 3.0 V
Output Photologic[®] Sensor						
V _{CC}	Operating D.C. Supply Voltage	4.5		16.0	V	
I _F (+)	LED Positive-Going Threshold Current	0.1	1.8	10.0	mA	V _{CC} = 5.0 V
I _F (+)/I _F (-)	Hysteresis Ratio	1.05	1.20	1.60		V _{CC} = 5.0 V
I _{CC} H	High Level Supply Current:					
	Buffer, 10K Pull-up Buffer, Open-Collector	OPB685 OPB686	5.0	12.0	mA	V _{CC} = 16 V, No Load On Output, I _F = 10 mA
	Inverter, 10K Pull-up Inverter, Open-Collector	OPB687 OPB688	4.0	12.0	mA	V _{CC} = 16 V, No Load On Output, I _F = 0 mA
	Low Level Supply Current:					
I _{CC} L	Buffer, 10K Pull-up Buffer, Open-Collector	OPB685 OPB686	5.5 4.0	12.0 12.0	mA	V _{CC} = 16 V, No Load On Output, I _F = 0 mA
	Inverter, 10K Pull-up Inverter, Open-Collector	OPB687 OPB688	6.5 5.0	12.0 12.0	mA	V _{CC} = 16 V, No Load On Output, I _F = 10 mA
V _{OH}	High Level Output Voltage:					
	Buffer, 10K Pull-up Inverter, 10K Pull-up	OPB685 OPB687	(V _{CC} -1.5) ⁽⁵⁾ (V _{CC} -1.5) ⁽⁵⁾		V	I _{OH} = 100 μA, I _F = 10 mA I _{OH} = 100 μA, I _F = 0 mA ⁽⁴⁾
I _{OH}	High Level Output Current:					
	Buffer, Open-Collector Inverter, Open-Collector	OPB686 OPB688		100 100	μA μA	V _{CC} = 16 V, V _{OH} = 30 V, I _F = 10 mA V _{CC} = 16 V, V _{OH} = 30 V, I _F = 0 mA
V _{OL}	Low Level Output Voltage:					
	Buffer, 10K Pull-up Buffer, Open-Collector	OPB685 OPB686		0.4	V	V _{CC} = 4.5 V, I _{OL} = 16 mA, I _F = 0 mA ⁽⁴⁾
	Inverter, 10K Pull-up Inverter, Open-Collector	OPB687 OPB688		0.4	V	V _{CC} = 4.5 V, I _{OL} = 16 mA, I _F = 10 mA
t _r , t _f	Output Rise Time, Output Fall Time		30		ns	V _{CC} = 5 V, I _F = 0 or 10 mA, f = 10 kHz, D.C. = 50%, R _L = 300 Ω
t _{PLH}	Propagation Delay, Low-High					
	Buffer, 10K Pull-up Buffer, Open-Collector	OPB685 OPB686	1.0		μs	
	Inverter, 10K Pull-up Inverter, Open-Collector	OPB687 OPB688	2.0		μs	
t _{PHL}	Propagation Delay, High-Low					
	Buffer, 10K Pull-up Buffer, Open-Collector	OPB685 OPB686	2.0		μs	
	Inverter, 10K Pull-up Inverter, Open-Collector	OPB687 OPB688	1.0		μs	

(4) Normal application would be with light source blocked, simulated by I_F = 0mA.

(5) V_{OH} = V_{CC}-1.5V for V_{CC} = 4.5V to 16V.

SLOTTED OPTICAL COMPONENTS

Optek reserves the right to make changes at any time in order to improve design and to supply the best product possible.

Optek Technology, Inc. 1215 W. Crosby Road Carrollton, Texas 75006 (972)323-2200 Fax (972)323-2396

Types OPB685, OPB686, OPB687, OPB688

Typical Performance Curves

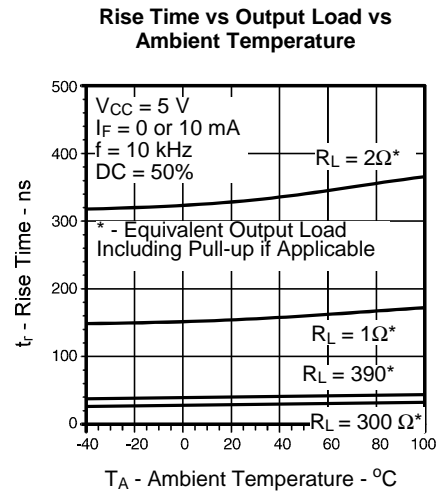
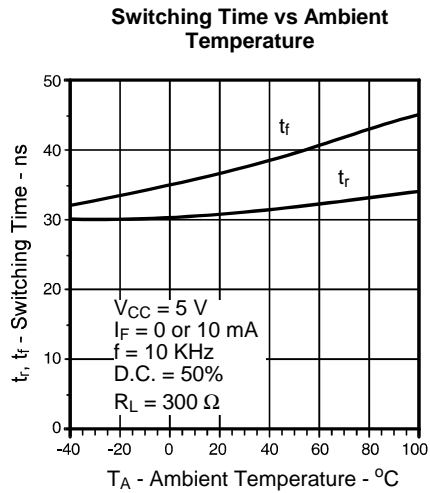

SLOTTED OPTICAL SEMICONDUCTORS

Typical Thermal Derating Curve

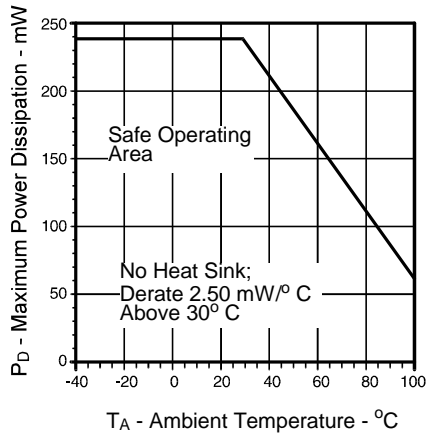

Schematics

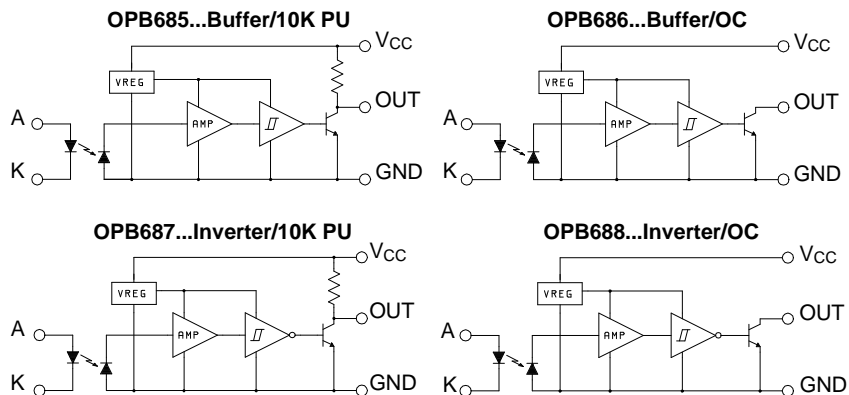

Optek reserves the right to make changes at any time in order to improve design and to supply the best product possible.

Optek Technology, Inc. 1215 W. Crosby Road Carrollton, Texas 75006 (972)323-2200 Fax (972)323-2396

Typical Performance Curves

Normalized Forward Voltage vs Ambient Temperature

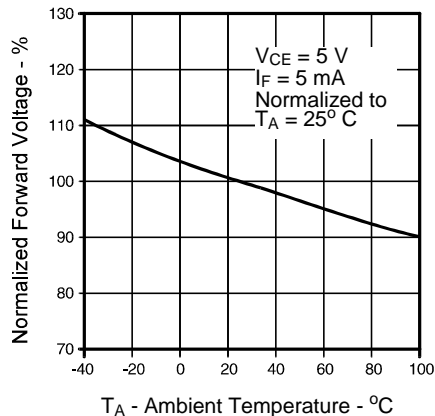

Forward Current vs Forward Voltage Input Diode

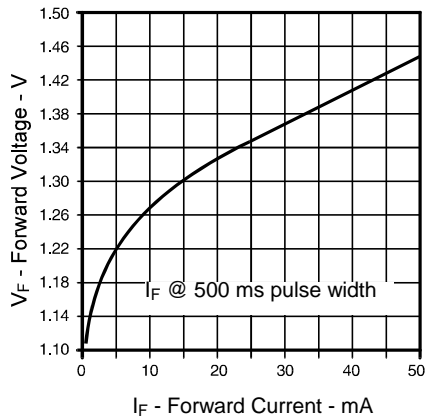

Trigger Current vs Ambient Temperature

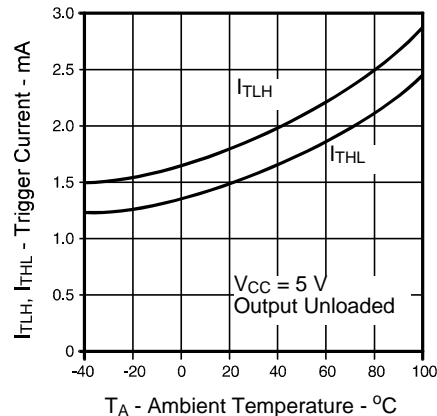

Normalized Supply Current vs Ambient Temperature

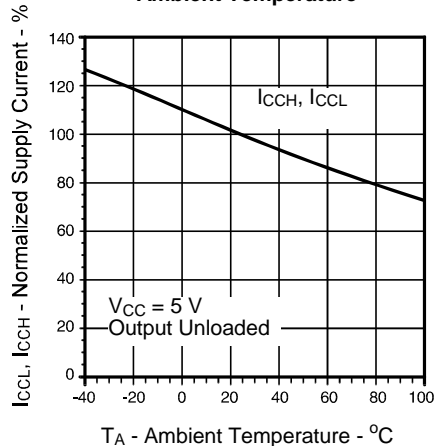

OPB685, OPB687 Normalized High Level Output Voltage vs Ambient Temperature

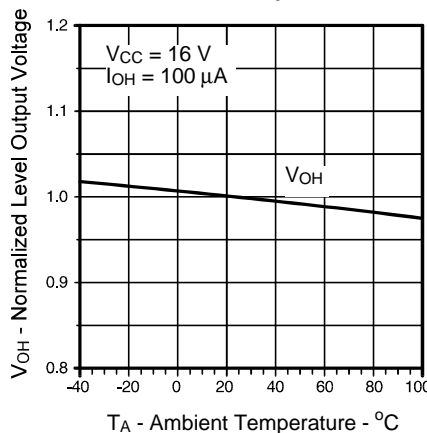

OPB686, OPB688 High Level Output Current vs Ambient Temperature

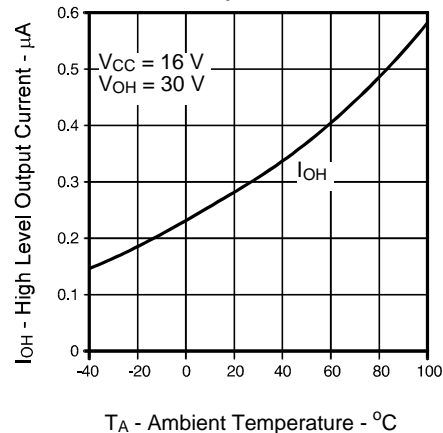

Low Level Output Voltage vs Ambient Temperature

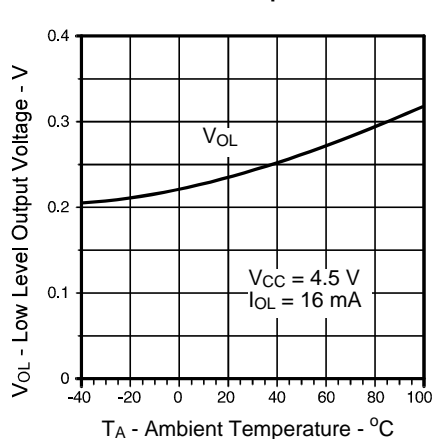

OPB685, OPB686 Propagation Delay vs Ambient Temperature

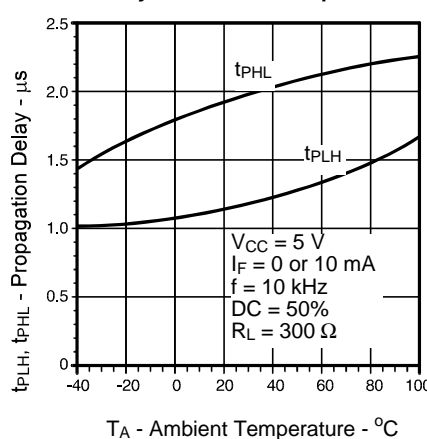

OPB687, OPB688 Propagation Delay vs Ambient Temperature

