

IRLS3036-7PPbF

HEXFET® Power MOSFET

www.datasheet4u.com

Applications

- DC Motor Drive
- High Efficiency Synchronous Rectification in SMPS
- Uninterruptible Power Supply
- High Speed Power Switching
- Hard Switched and High Frequency Circuits

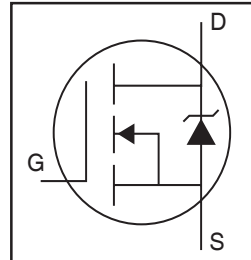

V_{DSS}	60V
R_{DS(on)} typ. max.	1.5mΩ
	1.9mΩ
I_D (Silicon Limited)	300A^①
I_D (Package Limited)	240A

Benefits

- Optimized for Logic Level Drive
- Very Low R_{DS(ON)} at 4.5V V_{GS}
- Superior R*Q at 4.5V V_{GS}
- Improved Gate, Avalanche and Dynamic dV/dt Ruggedness
- Fully Characterized Capacitance and Avalanche SOA
- Enhanced body diode dV/dt and dI/dt Capability
- Lead-Free

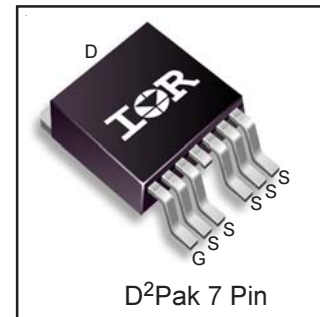

G	D	S
Gate	Drain	Source

Absolute Maximum Ratings

Symbol	Parameter	Max.	Units
I _D @ T _C = 25°C	Continuous Drain Current, V _{GS} @ 10V (Silicon Limited)	300 ^①	A
I _D @ T _C = 100°C	Continuous Drain Current, V _{GS} @ 10V (Silicon Limited)	210	
I _D @ T _C = 25°C	Continuous Drain Current, V _{GS} @ 10V (Package Limited)	240	
I _{DM}	Pulsed Drain Current ^②	1000	
P _D @ T _C = 25°C	Maximum Power Dissipation	380	W
	Linear Derating Factor	2.5	W/°C
V _{GS}	Gate-to-Source Voltage	± 16	V
dv/dt	Peak Diode Recovery ^④	8.1	V/ns
T _J	Operating Junction and	-55 to + 175	°C
T _{STG}	Storage Temperature Range		
	Soldering Temperature, for 10 seconds (1.6mm from case)	300	

Avalanche Characteristics

E _{AS} (Thermally limited)	Single Pulse Avalanche Energy ^③	300	mJ
I _{AR}	Avalanche Current ^②	See Fig. 14, 15, 22a, 22b	A
E _{AR}	Repetitive Avalanche Energy ^②		mJ

Thermal Resistance

Symbol	Parameter	Typ.	Max.	Units
R _{θJC}	Junction-to-Case ^{⑨⑩}	—	0.40	°C/W
R _{θJA}	Junction-to-Ambient (PCB Mount, steady state) ^⑧	—	40	

Static @ $T_J = 25^\circ\text{C}$ (unless otherwise specified)

Symbol	Parameter	Min.	Typ.	Max.	Units	Conditions
$V_{(BR)DSS}$	Drain-to-Source Breakdown Voltage	60	—	—	V	$V_{GS} = 0V, I_D = 250\mu A$
$\Delta V_{(BR)DSS}/\Delta T_J$	Breakdown Voltage Temp. Coefficient	—	0.059	—	V/ $^\circ\text{C}$	Reference to $25^\circ\text{C}, I_D = 5mA$ ②
$R_{DS(on)}$	Static Drain-to-Source On-Resistance	—	1.5	1.9	m Ω	$V_{GS} = 10V, I_D = 180A$ ③
		—	1.7	2.2		$V_{GS} = 4.5V, I_D = 150A$ ③
$V_{GS(th)}$	Gate Threshold Voltage	1.0	—	2.5	V	$V_{DS} = V_{GS}, I_D = 250\mu A$
I_{DSS}	Drain-to-Source Leakage Current	—	—	20	μA	$V_{DS} = 60V, V_{GS} = 0V$
		—	—	250		$V_{DS} = 60V, V_{GS} = 0V, T_J = 125^\circ\text{C}$
I_{GSS}	Gate-to-Source Forward Leakage	—	—	100	nA	$V_{GS} = 16V$
	Gate-to-Source Reverse Leakage	—	—	-100		$V_{GS} = -16V$
$R_{G(int)}$	Internal Gate Resistance	—	1.9	—	Ω	

Dynamic @ $T_J = 25^\circ\text{C}$ (unless otherwise specified)

Symbol	Parameter	Min.	Typ.	Max.	Units	Conditions
gfs	Forward Transconductance	390	—	—	S	$V_{DS} = 10V, I_D = 180A$
Q_g	Total Gate Charge	—	110	160	nC	$I_D = 180A$
Q_{gs}	Gate-to-Source Charge	—	33	—		$V_{DS} = 30V$
Q_{gd}	Gate-to-Drain ("Miller") Charge	—	53	—		$V_{GS} = 4.5V$ ⑤
Q_{sync}	Total Gate Charge Sync. ($Q_g - Q_{gd}$)	—	57	—		$I_D = 180A, V_{DS} = 0V, V_{GS} = 4.5V$
$t_{d(on)}$	Turn-On Delay Time	—	81	—	ns	$V_{DD} = 39V$
t_r	Rise Time	—	540	—		$I_D = 180A$
$t_{d(off)}$	Turn-Off Delay Time	—	89	—		$R_G = 2.1\Omega$
t_f	Fall Time	—	170	—		$V_{GS} = 4.5V$ ⑤
C_{iss}	Input Capacitance	—	11270	—	pF	$V_{GS} = 0V$
C_{oss}	Output Capacitance	—	1025	—		$V_{DS} = 50V$
C_{riss}	Reverse Transfer Capacitance	—	520	—		$f = 1.0MHz$
$C_{oss \text{ eff. (ER)}}$	Effective Output Capacitance (Energy Related) ⑦	—	1460	—		$V_{GS} = 0V, V_{DS} = 0V \text{ to } 48V$ ⑦
$C_{oss \text{ eff. (TR)}}$	Effective Output Capacitance (Time Related) ⑥	—	1630	—		$V_{GS} = 0V, V_{DS} = 0V \text{ to } 48V$ ⑥

Diode Characteristics

Symbol	Parameter	Min.	Typ.	Max.	Units	Conditions
I_S	Continuous Source Current (Body Diode)	—	—	300	A	MOSFET symbol showing the integral reverse p-n junction diode.
I_{SM}	Pulsed Source Current (Body Diode) ③	—	—	1000		
V_{SD}	Diode Forward Voltage	—	—	1.3	V	$T_J = 25^\circ\text{C}, I_S = 180A, V_{GS} = 0V$ ⑤
t_{rr}	Reverse Recovery Time	—	57	—	ns	$T_J = 25^\circ\text{C}$ $V_R = 51V,$
		—	60	—		$T_J = 125^\circ\text{C}$ $I_F = 180A$
Q_{rr}	Reverse Recovery Charge	—	140	—	nC	$T_J = 25^\circ\text{C}$ $di/dt = 100A/\mu s$ ⑤
		—	160	—		$T_J = 125^\circ\text{C}$
I_{RRM}	Reverse Recovery Current	—	4.6	—	A	$T_J = 25^\circ\text{C}$
t_{on}	Forward Turn-On Time	Intrinsic turn-on time is negligible (turn-on is dominated by LS+LD)				

Notes:

- ① Calculated continuous current based on maximum allowable junction temperature Bond wire current limit is 195A. Note that current limitation arising from heating of the device leads may occur with some lead mounting arrangements.
- ② Repetitive rating; pulse width limited by max. junction temperature.
- ③ Limited by T_{Jmax} , starting $T_J = 25^\circ\text{C}, L = 0.018mH$
 $R_G = 25\Omega, I_{AS} = 180A, V_{GS} = 10V$. Part not recommended for use above this value.
- ④ $I_{SD} \leq 180A, di/dt \leq 1070A/\mu s, V_{DD} \leq V_{(BR)DSS}, T_J \leq 175^\circ\text{C}$.

- ⑤ Pulse width $\leq 400\mu s$; duty cycle $\leq 2\%$.
- ⑥ $C_{oss \text{ eff. (TR)}}$ is a fixed capacitance that gives the same charging time as C_{oss} while V_{DS} is rising from 0 to 80% V_{DSS} .
- ⑦ $C_{oss \text{ eff. (ER)}}$ is a fixed capacitance that gives the same energy as C_{oss} while V_{DS} is rising from 0 to 80% V_{DSS} .
- ⑧ When mounted on 1" square PCB (FR-4 or G-10 Material). For recommended footprint and soldering techniques refer to application note # AN-994 techniques refer to application note #AN-994.
- ⑨ $R_{\theta j}$ is measured at T_J approximately 90°C .
- ⑩ $R_{\theta JC}$ value shown is at time zero.

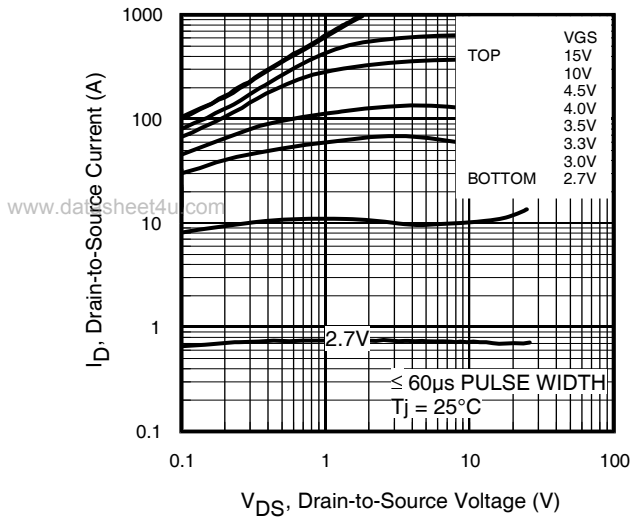

Fig 1. Typical Output Characteristics

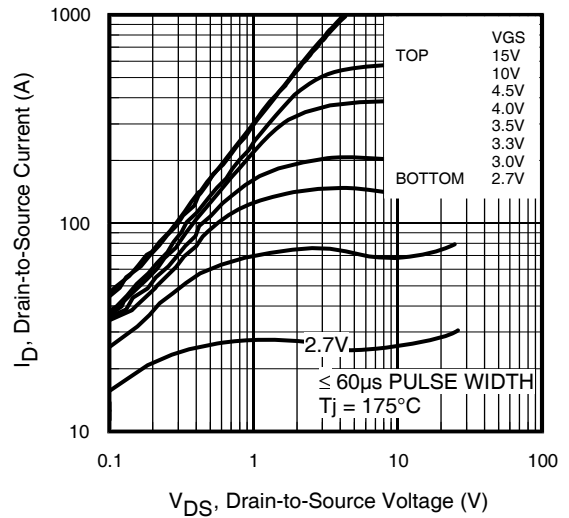

Fig 2. Typical Output Characteristics

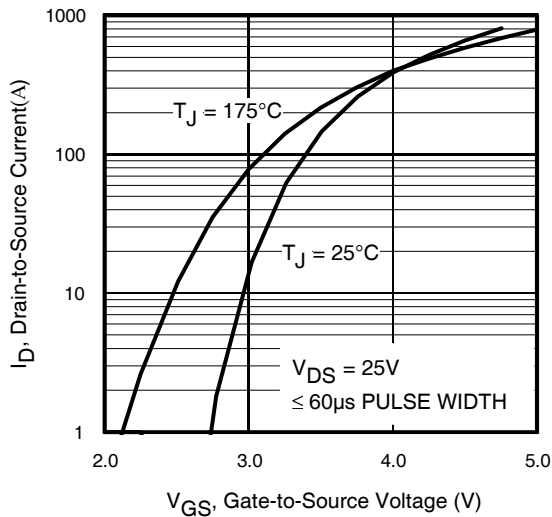

Fig 3. Typical Transfer Characteristics

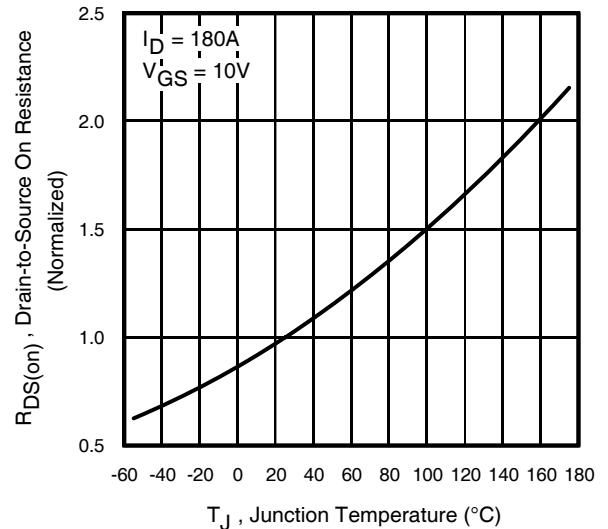

Fig 4. Normalized On-Resistance vs. Temperature

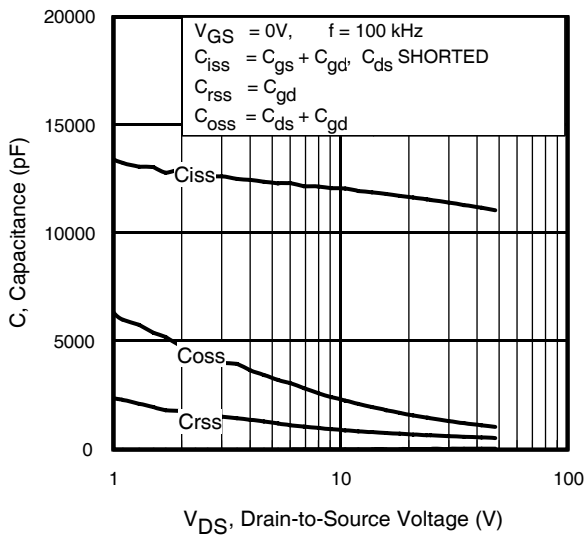

Fig 5. Typical Capacitance vs. Drain-to-Source Voltage

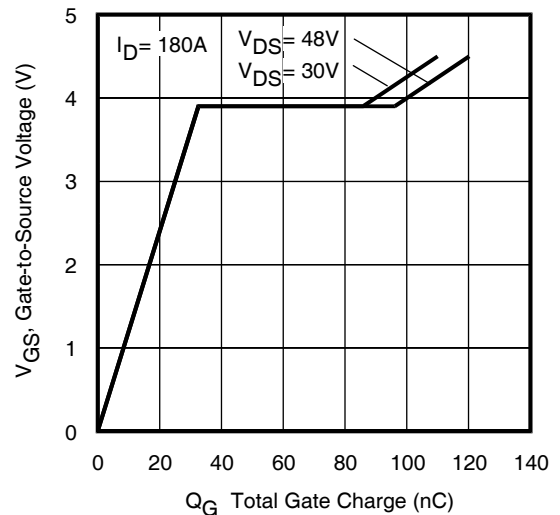

Fig 6. Typical Gate Charge vs. Gate-to-Source Voltage

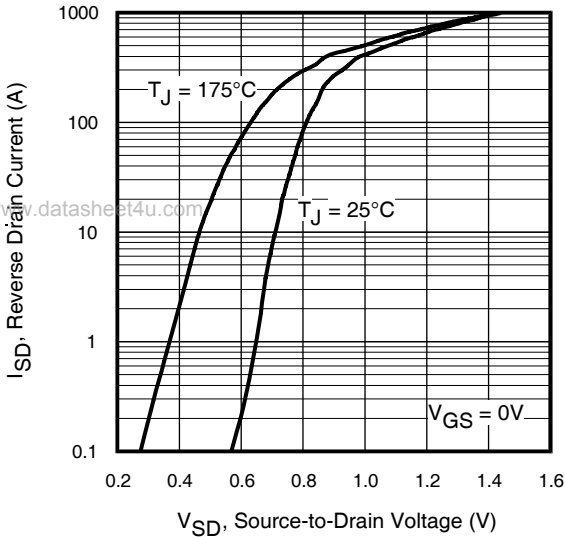

Fig 7. Typical Source-Drain Diode Forward Voltage

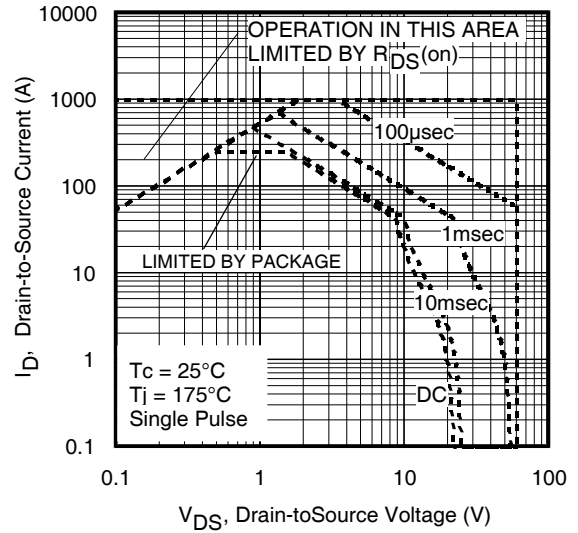

Fig 8. Maximum Safe Operating Area

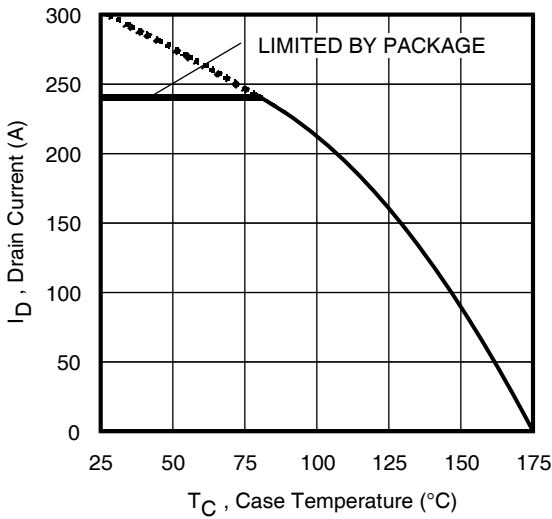

Fig 9. Maximum Drain Current vs. Case Temperature

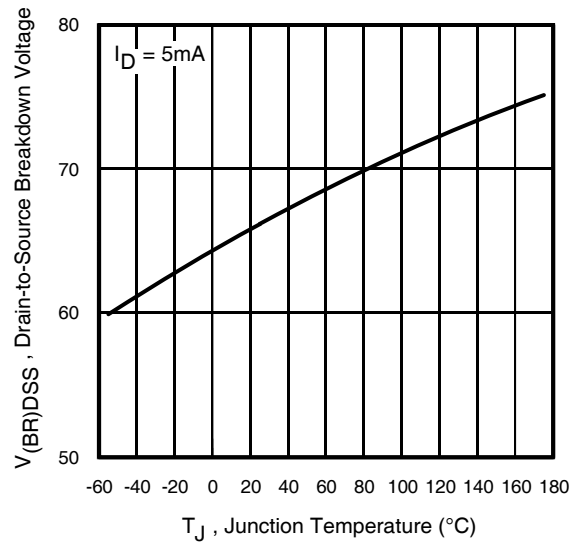

Fig 10. Drain-to-Source Breakdown Voltage

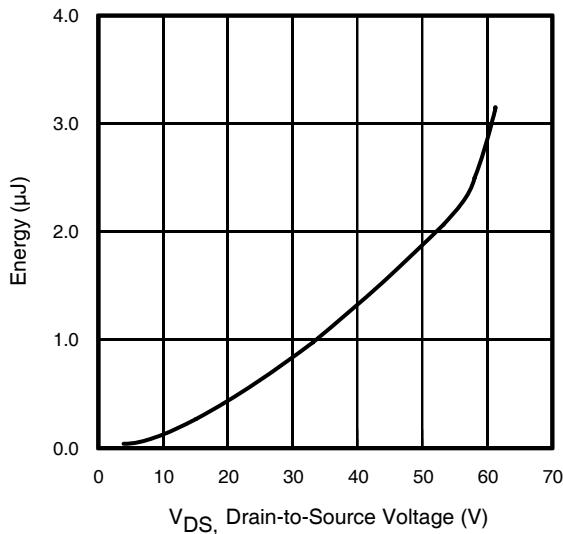

Fig 11. Typical C_{OSS} Stored Energy

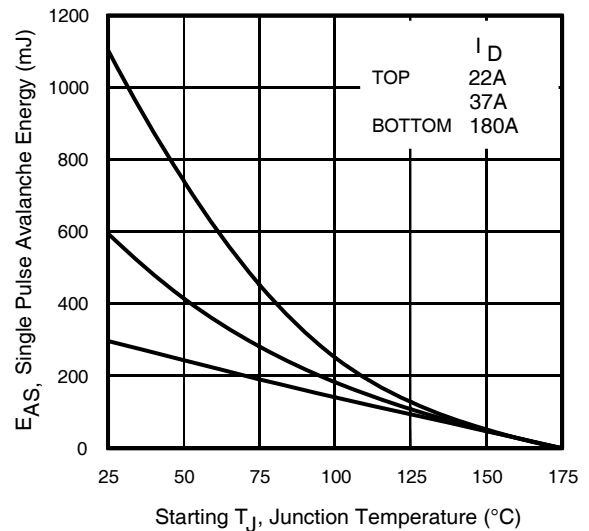

Fig 12. Maximum Avalanche Energy Vs. Drain Current

www.datasheet4u.com

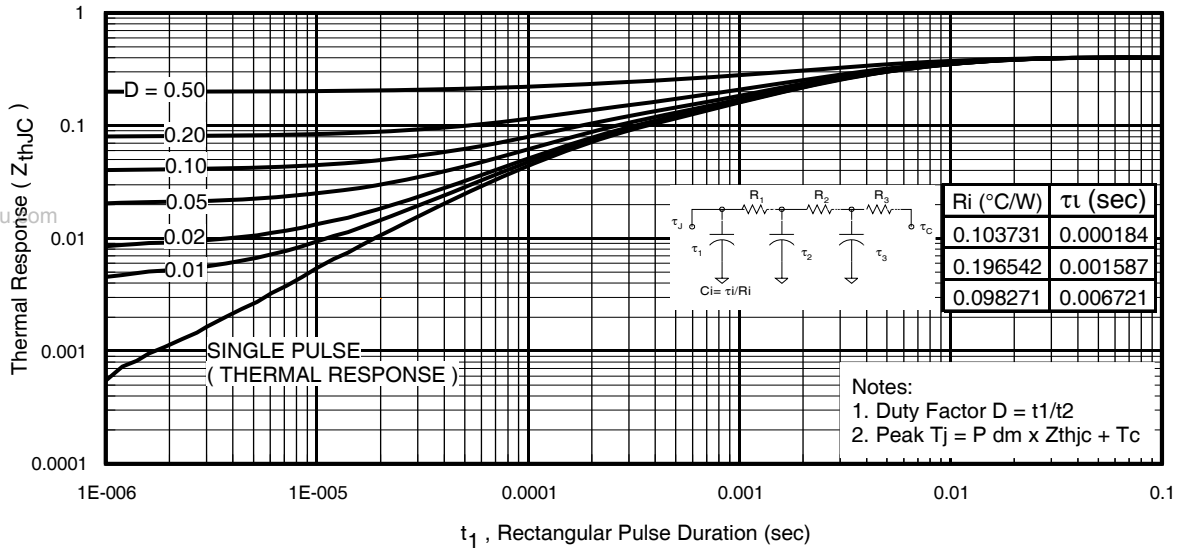

Fig 13. Maximum Effective Transient Thermal Impedance, Junction-to-Case

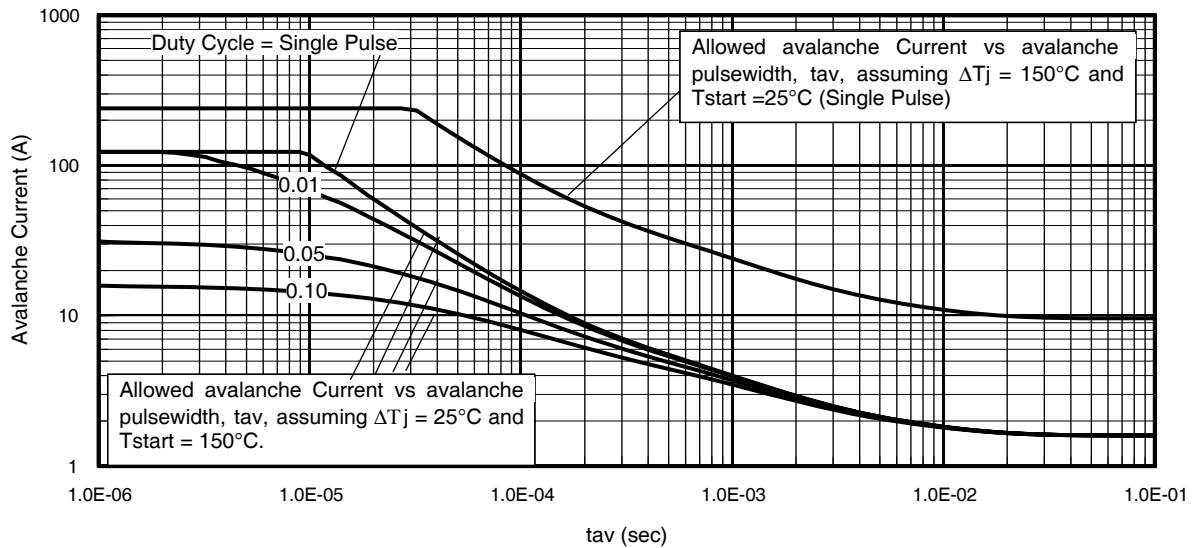
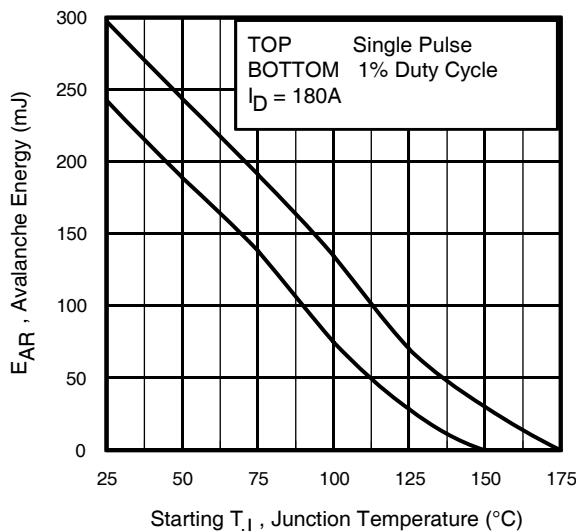

Fig 14. Typical Avalanche Current vs.Pulsewidth



Notes on Repetitive Avalanche Curves , Figures 14, 15:
(For further info, see AN-1005 at www.irf.com)

1. Avalanche failures assumption:
Purely a thermal phenomenon and failure occurs at a temperature far in excess of Tjmax. This is validated for every part type.
2. Safe operation in Avalanche is allowed as long as Tjmax is not exceeded.
3. Equation below based on circuit and waveforms shown in Figures 22a, 22b.
4. PD(ave) = Average power dissipation per single avalanche pulse.
5. BV = Rated breakdown voltage (1.3 factor accounts for voltage increase during avalanche).
6. Iav = Allowable avalanche current.
7. ΔT = Allowable rise in junction temperature, not to exceed Tjmax (assumed as 25°C in Figure 14, 15).
tav = Average time in avalanche.
D = Duty cycle in avalanche = tav · f
ZthJC(D, tav) = Transient thermal resistance, see Figures 13)

$$P_D(ave) = 1/2 (1.3 \cdot BV \cdot I_{av}) = \Delta T / Z_{thJC}$$

$$I_{av} = 2\Delta T / [1.3 \cdot BV \cdot Z_{th}]$$

$$E_{AS}(AR) = P_D(ave) \cdot t_{av}$$

Fig 15. Maximum Avalanche Energy vs. Temperature

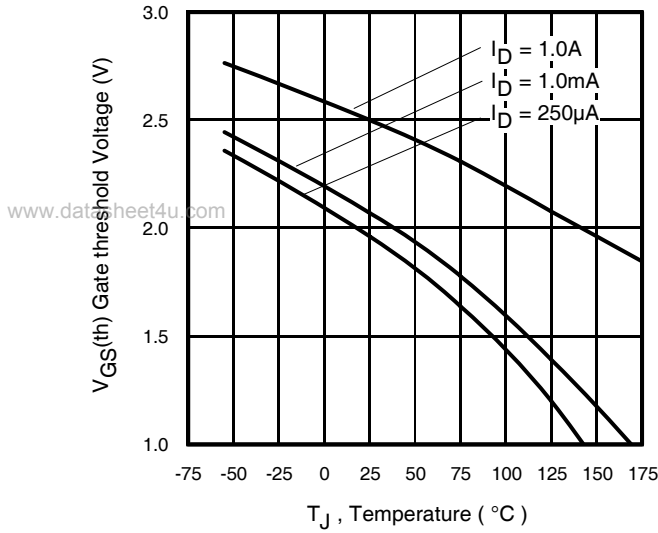

Fig 16. Threshold Voltage Vs. Temperature

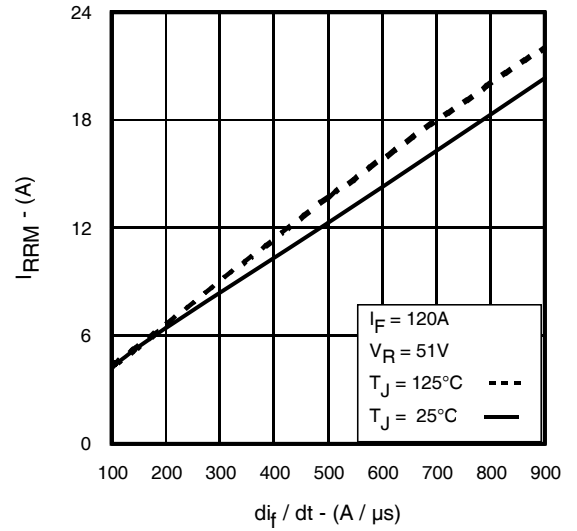

Fig. 17 - Typical Recovery Current vs. di_f/dt

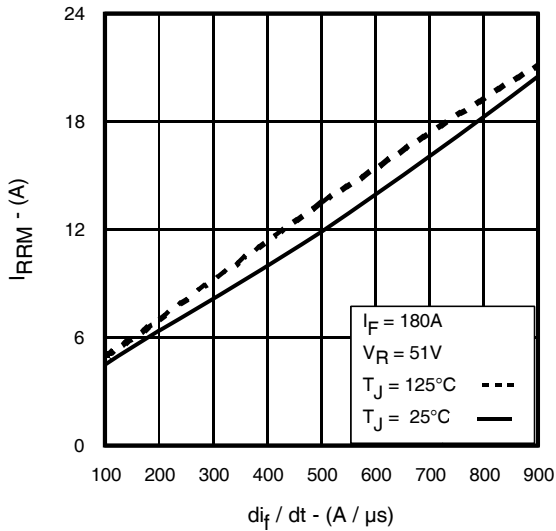

Fig. 18 - Typical Recovery Current vs. di_f/dt

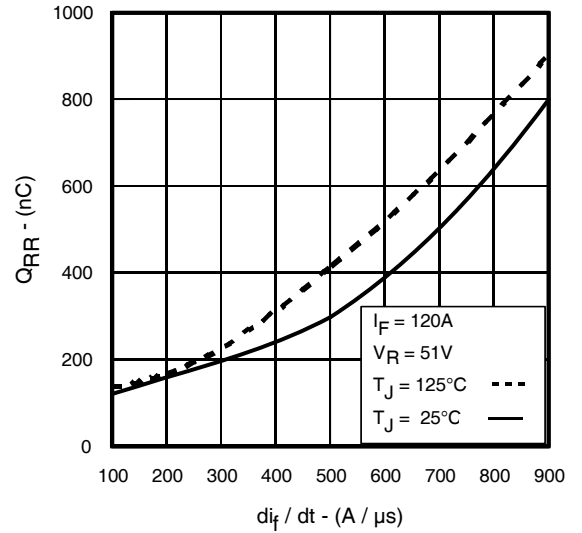

Fig. 19 - Typical Stored Charge vs. di_f/dt

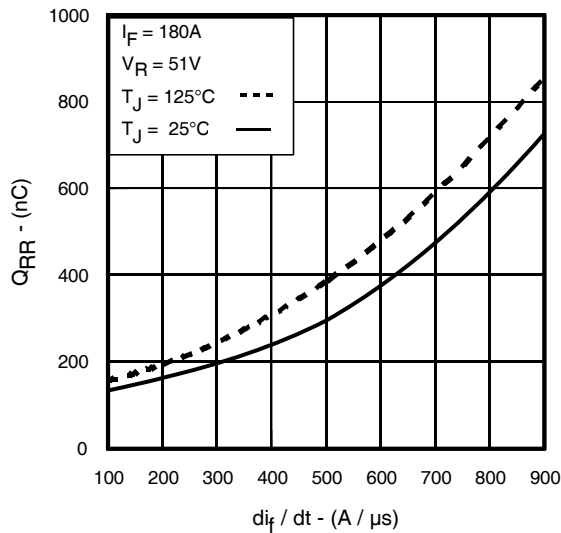

Fig. 20 - Typical Stored Charge vs. di_f/dt

www.datasheet4u.com

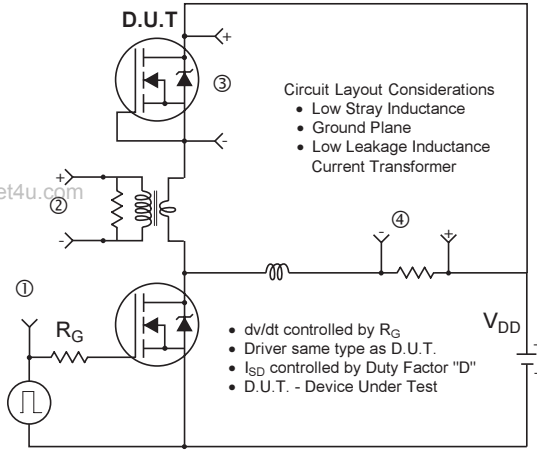
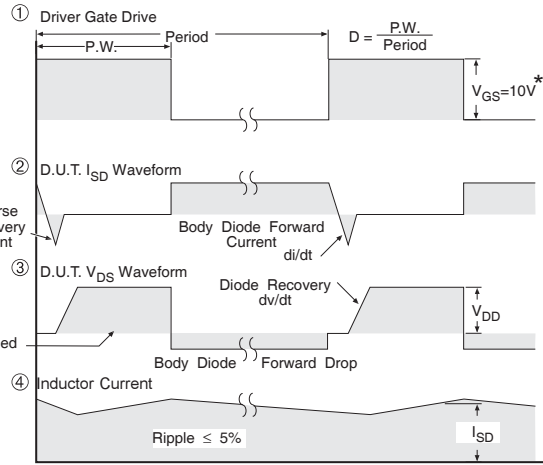

Fig 21. Peak Diode Recovery dv/dt Test Circuit for N-Channel HEXFET[®] Power MOSFETs



* $V_{GS} = 5V$ for Logic Level Devices

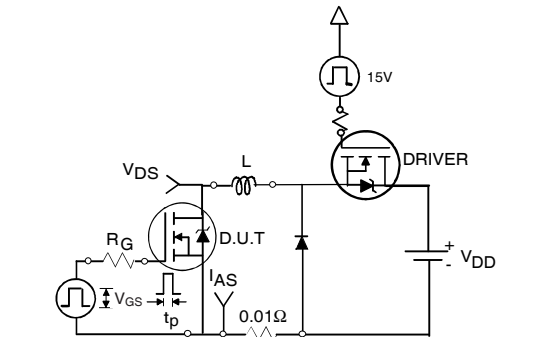

Fig 22a. Unclamped Inductive Test Circuit

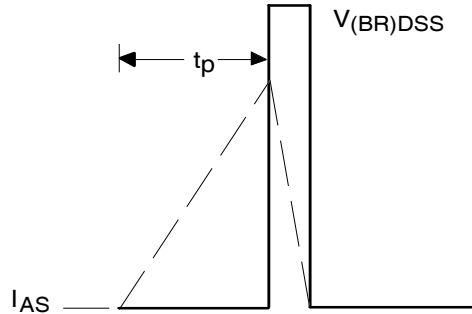

Fig 22b. Unclamped Inductive Waveforms

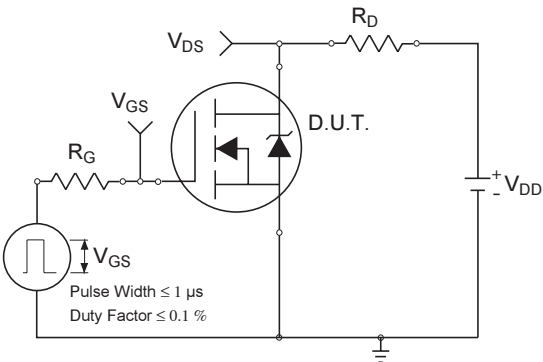

Fig 23a. Switching Time Test Circuit

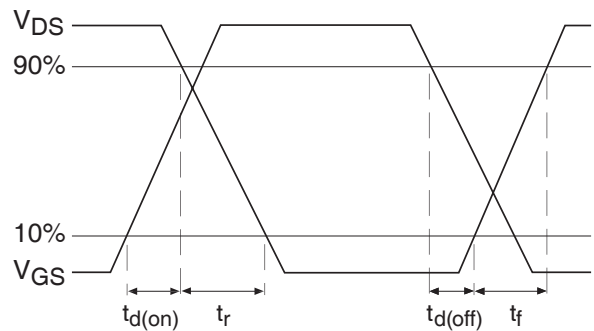

Fig 23b. Switching Time Waveforms

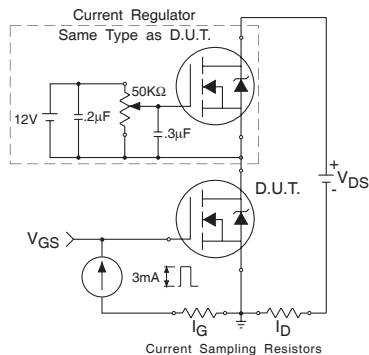

Fig 24a. Gate Charge Test Circuit

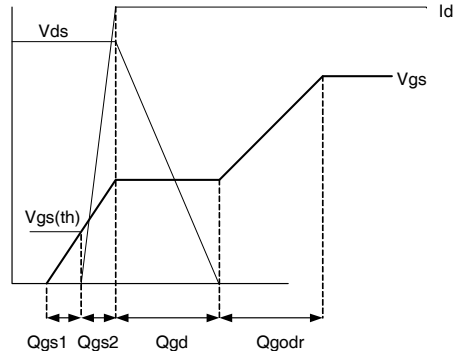
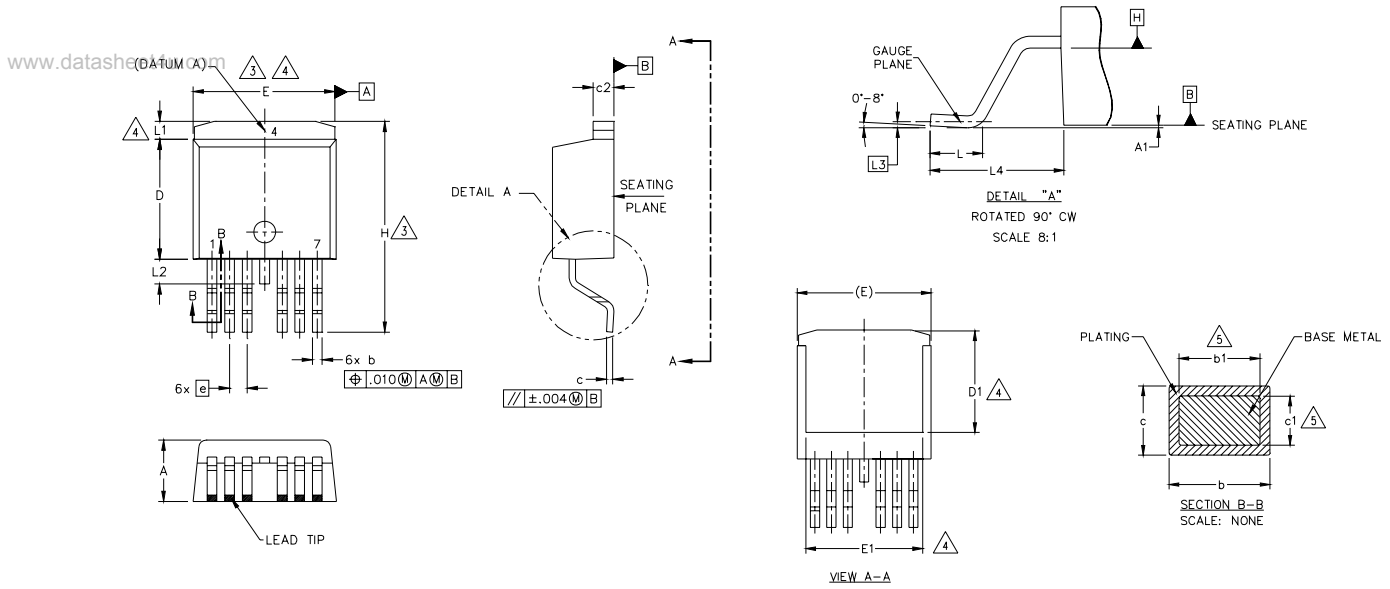

Fig 24b. Gate Charge Waveforms

D²Pak - 7 Pin Package Outline

Dimensions are shown in millimeters (inches)



SYMBOL	DIMENSIONS				NOTES	
	MILLIMETERS		INCHES			
	MIN.	MAX.	MIN.	MAX.		
A	4.06	4.83	.160	.190	5	
A1	-	0.254	-	.010		
b	0.51	0.99	.020	.036		
b1	0.51	0.89	.020	.032		
c	0.38	0.74	.015	.029		
c1	0.38	0.58	.015	.023		
c2	1.14	1.65	.045	.065		
D	8.38	9.65	.330	.380		3
D1	6.86	-	.270	-		4
E	9.65	10.67	.380	.420		3,4
E1	6.22	-	.245	-	4	
e	1.27 BSC		.050 BSC		4	
H	14.61	15.88	.575	.625		
L	1.78	2.79	.070	.110		
L1	-	1.68	-	.066		
L2	-	1.78	-	.070		
L3	0.25 BSC		.010 BSC			
L4	4.78	5.28	.188	.208		

- NOTES:
1. DIMENSIONING AND TOLERANCING AS PER ASME Y14.5M-1994
 2. DIMENSIONS ARE SHOWN IN MILLIMETERS [INCHES].
 3. DIMENSION D & E DO NOT INCLUDE MOLD FLASH. MOLD FLASH SHALL NOT EXCEED 0.127 [.005"] PER SIDE. THESE DIMENSIONS ARE MEASURED AT THE OUTMOST EXTREMES OF THE PLASTIC BODY AT DATUM H.
 4. THERMAL PAD CONTOUR OPTIONAL WITHIN DIMENSION E, L1, D1 & E1.
 5. DIMENSION b1 AND c1 APPLY TO BASE METAL ONLY.
 6. DATUM A & B TO BE DETERMINED AT DATUM PLANE H.
 7. CONTROLLING DIMENSION: INCH.
 8. OUTLINE CONFORMS TO JEDEC OUTLINE TO-263CB.

Note: For the most current drawing please refer to IR website at <http://www.irf.com/package/>

D²Pak - 7 Pin Part Marking Information

EXAMPLE: THIS IS AN IRF2804S-7P WITH
 LOT CODE 8024
 ASSEMBLED ON WW02,2000
 IN THE ASSEMBLY LINE "L"

www.datasheet4u.com

Note: "P" in assembly line
 position indicates "Lead Free"

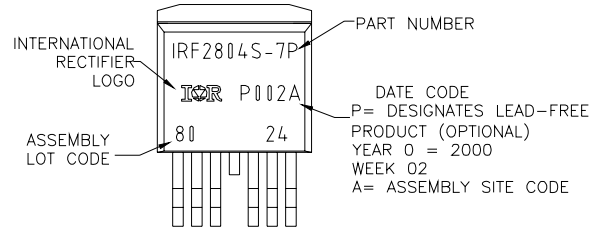
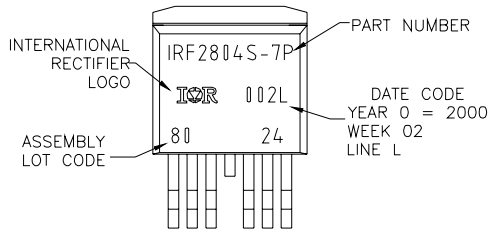

D²Pak - 7 Pin Tape and Reel

NOTES, TAPE & REEL, LABELLING:

1. TAPE AND REEL.
 - 1.1 REEL SIZE 13 INCH DIAMETER.
 - 1.2 EACH REEL CONTAINING 800 DEVICES.
 - 1.3 THERE SHALL BE A MINIMUM OF 42 SEALED POCKETS CONTAINED IN THE LEADER AND A MINIMUM OF 15 SEALED POCKETS IN THE TRAILER.
 - 1.4 PEEL STRENGTH MUST CONFORM TO THE SPEC. NO. 71-9667.
 - 1.5 PART ORIENTATION SHALL BE AS SHOWN BELOW.
 - 1.6 REEL MAY CONTAIN A MAXIMUM OF TWO UNIQUE LOT CODE/DATE CODE COMBINATIONS. REWORKED REELS MAY CONTAIN A MAXIMUM OF THREE UNIQUE LOT CODE/DATE CODE COMBINATIONS. HOWEVER, THE LOT CODES AND DATE CODES WITH THEIR RESPECTIVE QUANTITIES SHALL APPEAR ON THE BAR CODE LABEL FOR THE AFFECTED REEL.

2. LABELLING (REEL AND SHIPPING BAG).
 - 2.1 CUST. PART NUMBER (BAR CODE): IRFXXXXSTRL-7P
 - 2.2 CUST. PART NUMBER (TEXT CODE): IRFXXXXSTRL-7P
 - 2.3 I.R. PART NUMBER: IRFXXXXSTRL-7P
 - 2.4 QUANTITY:
 - 2.5 VENDOR CODE: IR
 - 2.6 LOT CODE:
 - 2.7 DATE CODE:

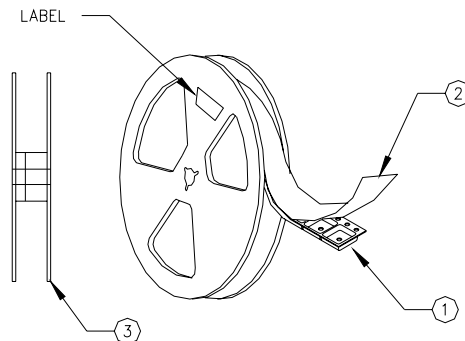
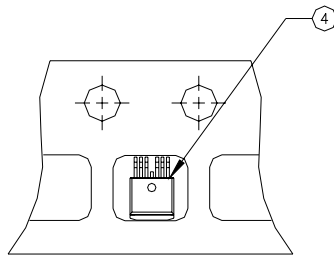

Note: For the most current drawing please refer to IR website at: <http://www.irf.com/package/>

Data and specifications subject to change without notice.
 This product has been designed and qualified for the Industrial market.
 Qualification Standards can be found on IR's Web site.

International
IR Rectifier

IR WORLD HEADQUARTERS: 233 Kansas St., El Segundo, California 90245, USA Tel: (310) 252-7105
 TAC Fax: (310) 252-7903

Visit us at www.irf.com for sales contact information 12/08