

SAW FILTER FOR CDMA1900/UMTS BC2 Rx

Murata part number : SAFEB1G88KA0F00

Package Dimensions

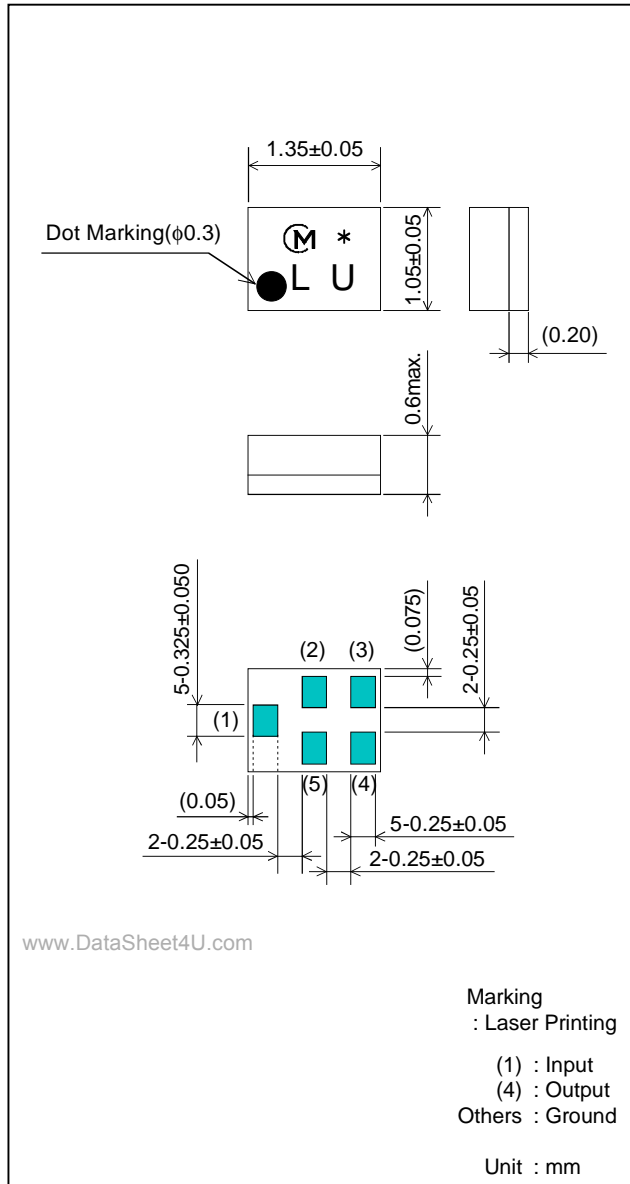

Specification

Item	Specification		
	-30 to 85°C	25 \pm 2°C	typ.
Nominal Center Frequency(fc)	1880MHz		
Insertion Loss (1850 to 1910MHz)	4.0 dB max.	3.4 dB max.	2.4 dB
Absolute Attenuation			
1) 0.1 to 869 MHz	28 dB min.	28 dB min.	31 dB
2) 869 to 894 MHz	28 dB min.	28 dB min.	31 dB
3) 894 to 1500 MHz	28 dB min.	28 dB min.	31 dB
4) 1574 to 1577 MHz	30 dB min.	30 dB min.	33 dB
5) 1930 to 1990 MHz	14 dB min.	18 dB min.	37 dB
6) 3690 to 3830 MHz	34 dB min.	34 dB min.	46 dB
7) 5540 to 5740 MHz	25 dB min.	25 dB min.	33 dB
8) 7390 to 7650 MHz	25 dB min.	25 dB min.	33 dB
Ripple Deviation (1850 to 1910MHz)	3.1dB max.	2.5dB max.	1.9 dB
VSWR (1850 to 1910MHz)	1.9 max.	1.8 max.	1.7
Input/Output Impedance (nominal)	50 Ω		
Input Signal Level	20mW (+13dBm), 2000 hours		

SAW FILTER FOR CDMA1900/UMTS BC2 Rx

Murata part number : SAFEB1G88KA0F00

■ Frequency Performance

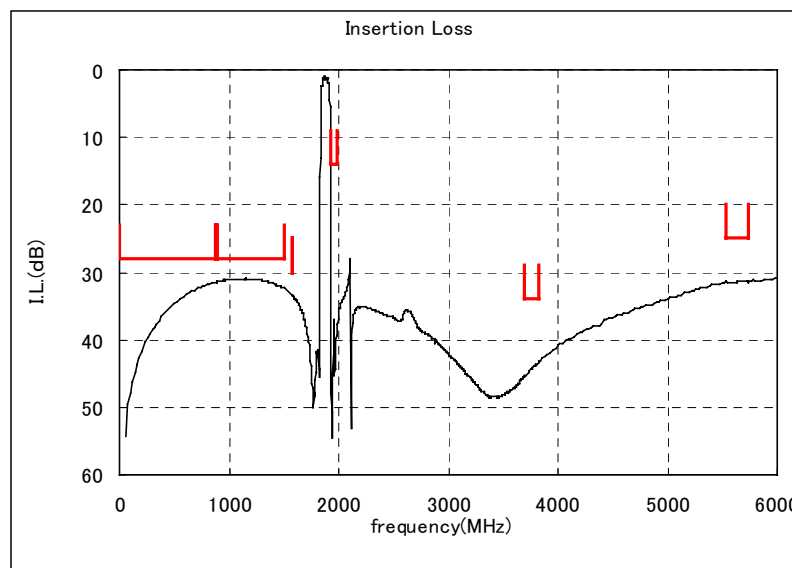
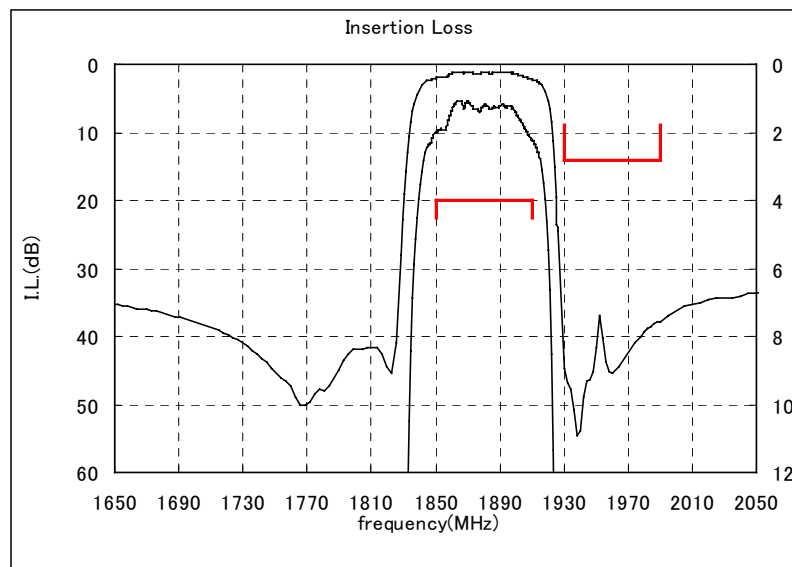

www.DataSheet4U.com

SAW FILTER FOR CDMA1900/UMTS BC2 Rx

Murata part number : SAFEB1G88KA0F00

■ Dimensions of Carrier Tape

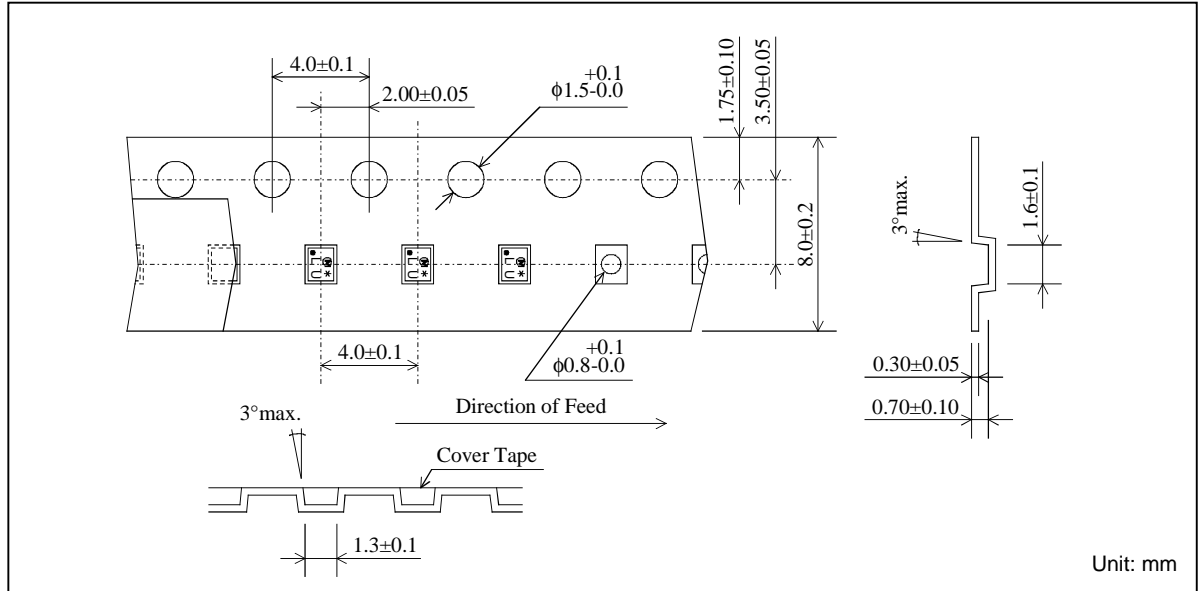

■ Dimensions of Tape

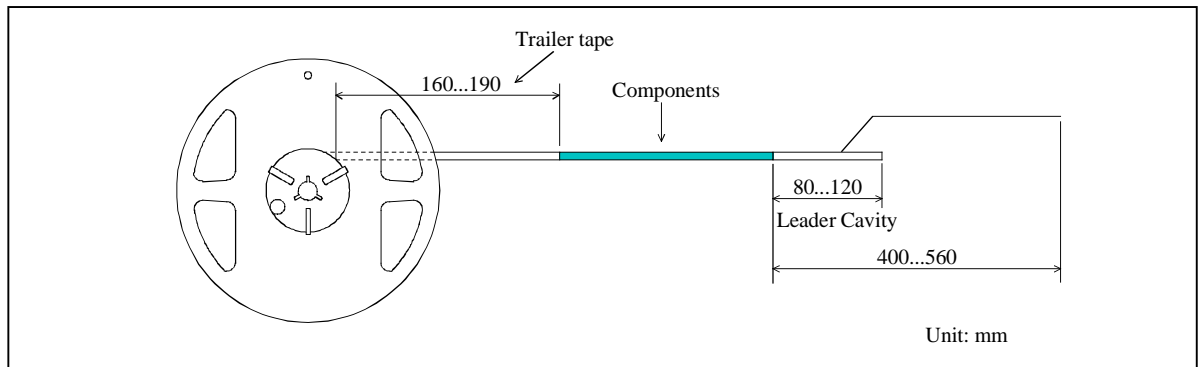

www.DataSheet4U.com

■ Dimensions of Reel

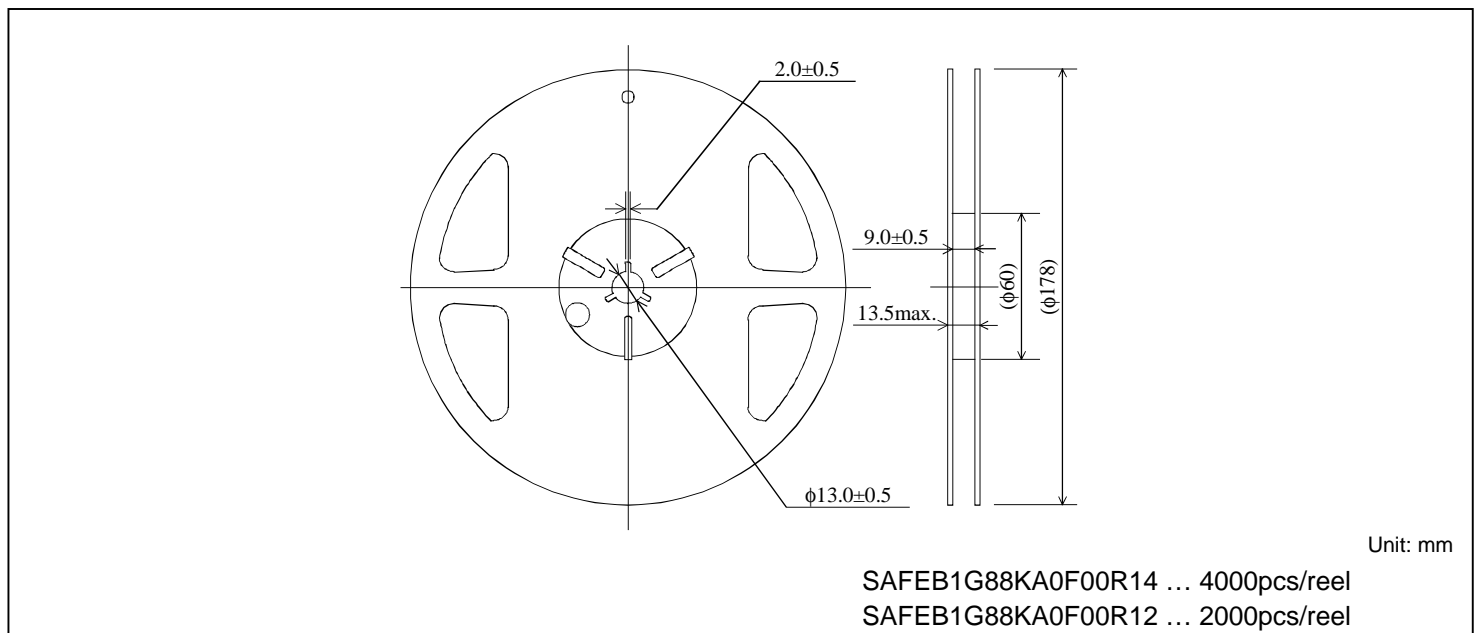

SAW FILTER FOR CDMA1900/UMTS BC2 Rx

Murata part number : SAFEB1G88KA0F00

Recommended Land Pattern

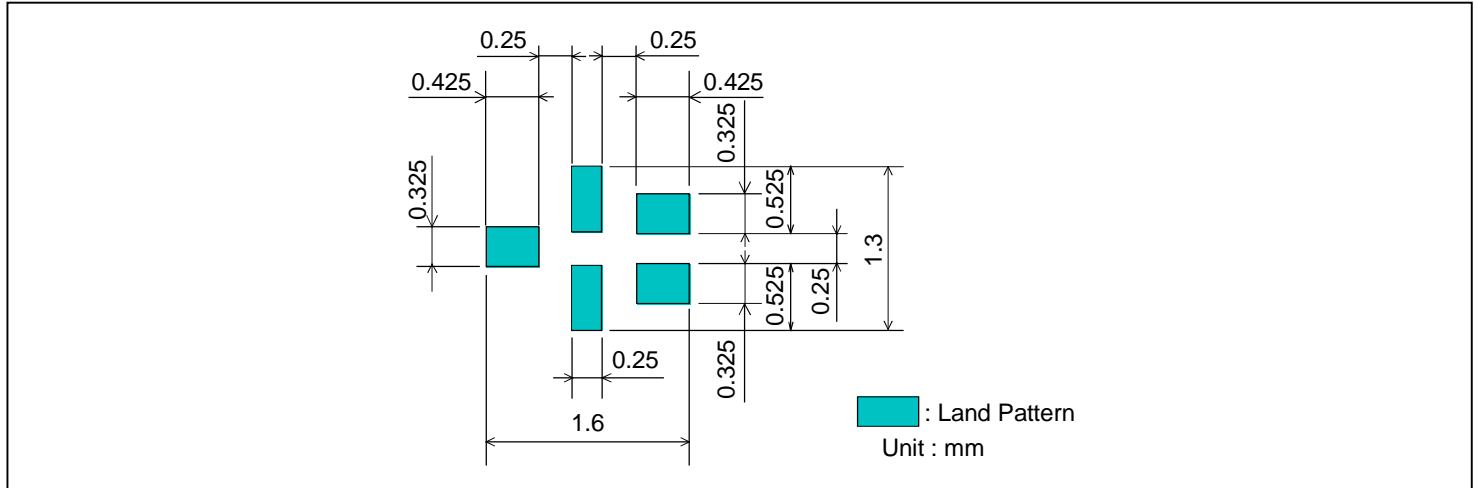

Test Circuit

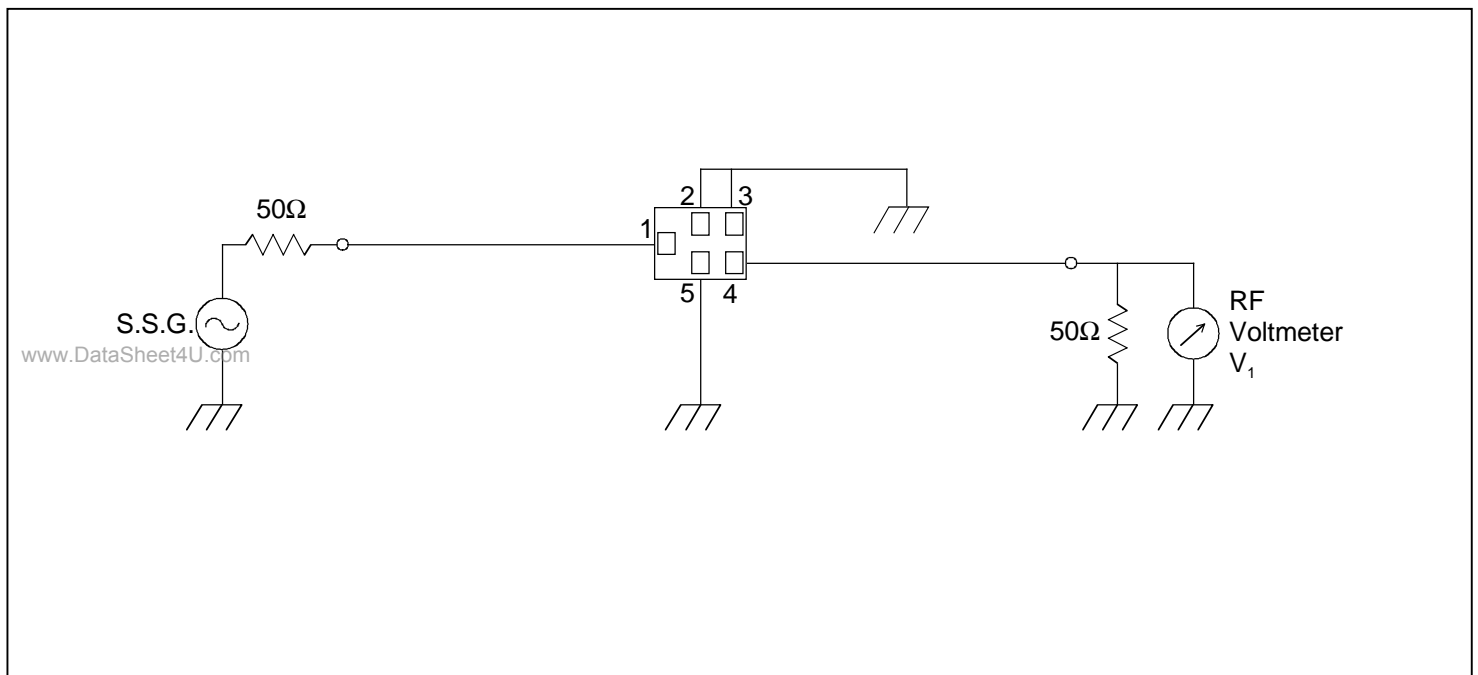

- This PDF Datasheet is downloaded from the website of Murata Manufacturing Co., Ltd. Therefore, it's specifications are subject to change or our products in it may be discontinued without advance notice. Please check with our sales representatives or product engineers before ordering.
- This PDF Datasheet has only typical specifications because there is no space for detailed specifications. Therefore, please approve our product specifications or transact the approval sheet for product specifications before ordering.