

SURFACE MOUNT
HIGH EFFICIENCY SILICON RECTIFIER
VOLTAGE RANGE 50 to 1000 Volts CURRENT 1.0 Ampere

FEATURES

- * Ideal for surface mounted applications
- * Low leakage current
- * Metallurgically bonded construction
- * Mounting position: Any
- * Weight: 0.057 gram

MECHANICAL DATA

- * Epoxy : Device has UL flammability classification 94V-0

MAXIMUM RATINGS AND ELECTRICAL CHARACTERISTICS

Ratings at 25 °C ambient temperature unless otherwise specified.
 Single phase, half wave, 60 Hz, resistive or inductive load.
 For capacitive load, derate current by 20%.

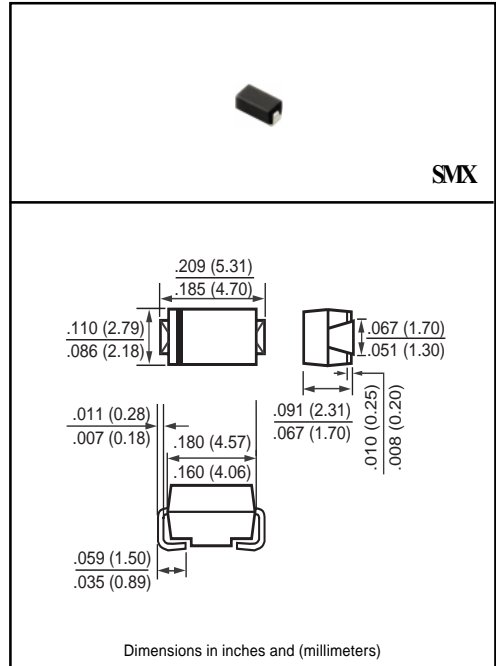

MAXIMUM RATINGS (At TA = 25°C unless otherwise noted)

RATINGS	SYMBOL	HFM101W	HFM102W	HFM103W	HFM104W	HFM105W	HFM106W	HFM107W	HFM108W	UNITS
Maximum Recurrent Peak Reverse Voltage	VRRM	50	100	200	300	400	600	800	1000	Volts
Maximum RMS Volts	VRMS	35	70	140	210	280	420	560	700	Volts
Maximum DC Blocking Voltage	Vdc	50	100	200	300	400	600	800	1000	Volts
Maximum Average Forward Current at TA = 50°C	Io	1.0								Amps
Peak Forward Surge Current 8.3 ms single half sine-wave superimposed on rated load (JEDEC method)	IFSM	30								Amps
Typical Junction Capacitance (Note 2)	Cj	15					12			pF
Operating and Storage Temperature Range	TJ, TSTG	-65 to + 150								°C

ELECTRICAL CHARACTERISTICS (At TA = 25°C unless otherwise noted)

CHARACTERISTICS	SYMBOL	HFM101W	HFM102W	HFM103W	HFM104W	HFM105W	HFM106W	HFM107W	HFM108W	UNITS
Maximum Forward Voltage at 1.0A DC	Vf	1.0			1.3		1.7			Volts
Maximum Full Load Reverse Current, Full cycle Average TA = 55°C	Ir	50								uAmps
Maximum DC Reverse Current at @ TA = 25°C		5.0								uAmps
Rated DC Blocking Voltage @ TA = 125°C		100								uAmps
Maximum Reverse Recovery Time (Note 1)	trr	50					75			nSec

NOTES : 1. Test Conditions: IF=0.5A, IR=-1.0A, IRR=-0.25A.
 2. Measured at 1 MHz and applied reverse voltage of 4.0 volts.

RATING AND CHARACTERISTIC CURVES (HFM101W THRU HFM108W)

FIG. 1 - TEST CIRCUIT DIAGRAM AND REVERSE RECOVERY TIME CHARACTERISTIC

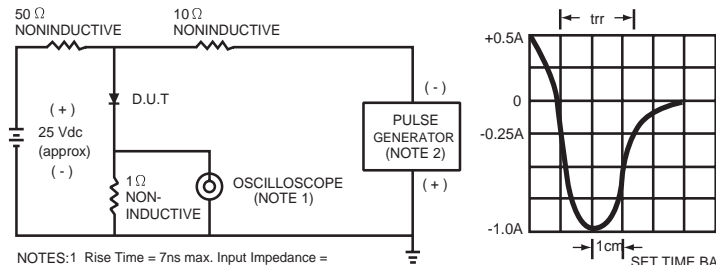

NOTES: 1 Rise Time = 7ns max. Input Impedance = 1 megohm. 22pF.
2. Rise Time = 10ns max. Source Impedance = 50 ohms.

FIG. 2 - TYPICAL FORWARD CURRENT DERATING CURVE

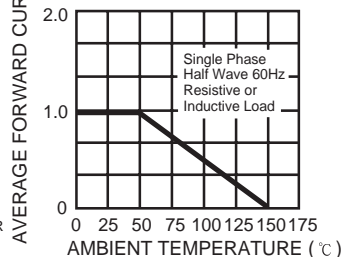

FIG. 3 - TYPICAL REVERSE CHARACTERISTICS

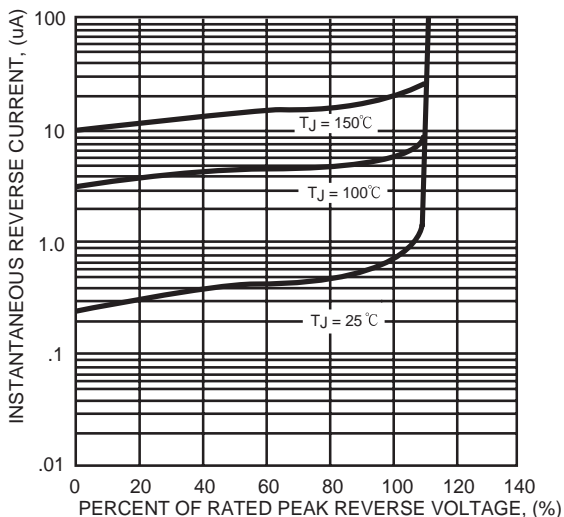

FIG. 4 - TYPICAL INSTANTANEOUS FORWARD CHARACTERISTICS

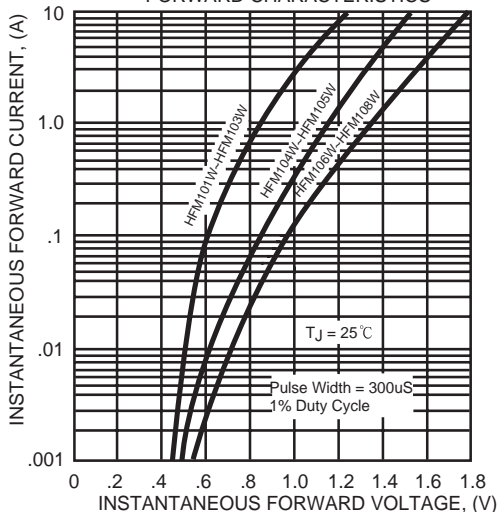

FIG. 5 - MAXIMUM NON-REPETITIVE FORWARD SURGE CURRENT

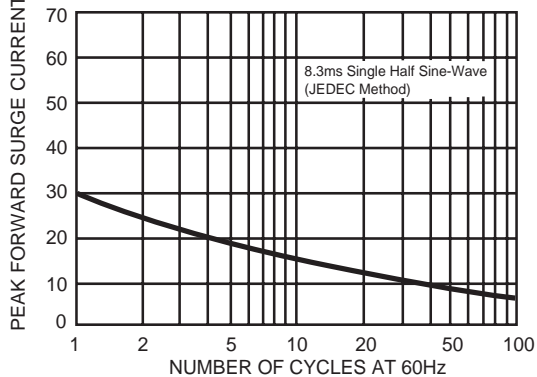
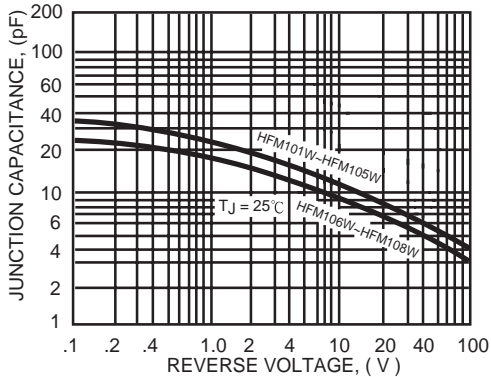
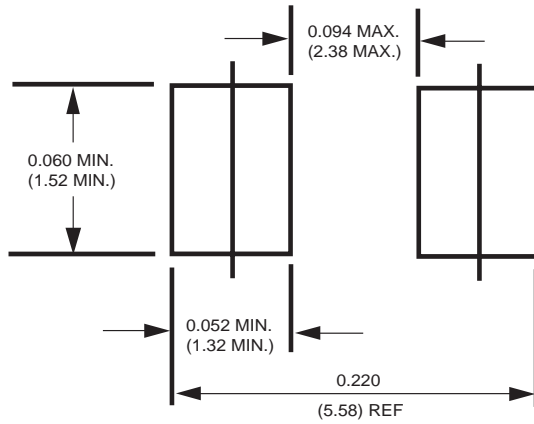

FIG. 6 - TYPICAL JUNCTION CAPACITANCE



Mounting Pad Layout



Dimensions in inches and (millimeters)