

Sync Signal, Timing Signal Generator for CCD Cameras

Description

The CXD1261AR is an IC which generates the sync signals and timing signals required for a camera system that uses the monochrome CCD image sensor (760H) such as the ICX038/039 and ICX058/059.

Features

- Compatible with monochrome (EIA/CCIR) systems
- Built-in electronic shutter function
- Built-in driver for the horizontal (H) clock
- Built-in SG and TG functions

Applications

CCD camera systems

Structure

Silicon gate CMOS

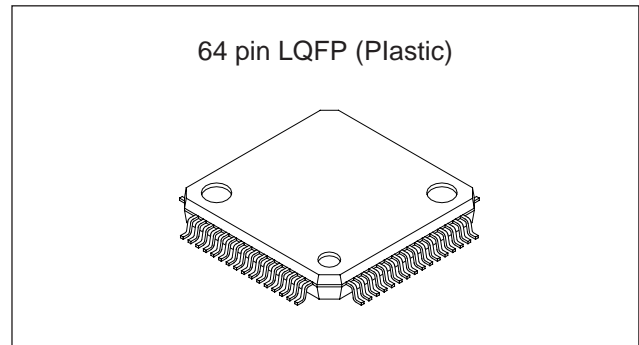

Absolute Maximum Ratings (Ta = 25°C, Vss = 0V)

• Supply voltage	V _{DD}	V _{SS} – 0.5 to +7.0	V
• Input voltage	V _I	V _{SS} – 0.5 to V _{DD} + 0.5	V
• Output voltage	V _O	V _{SS} – 0.5 to V _{DD} + 0.5	V
• Operating temperature	T _{opr}	–20 to +75	°C
• Storage temperature	T _{stg}	–55 to +150	°C

Recommended Operating Conditions

• Supply voltage	V _{DD}	5.0 ± 0.25	V
• Operating temperature	T _{opr}	–20 to +75	°C

Sony reserves the right to change products and specifications without prior notice. This information does not convey any license by any implication or otherwise under any patents or other right. Application circuits shown, if any, are typical examples illustrating the operation of the devices. Sony cannot assume responsibility for any problems arising out of the use of these circuits.

Pin Configuration

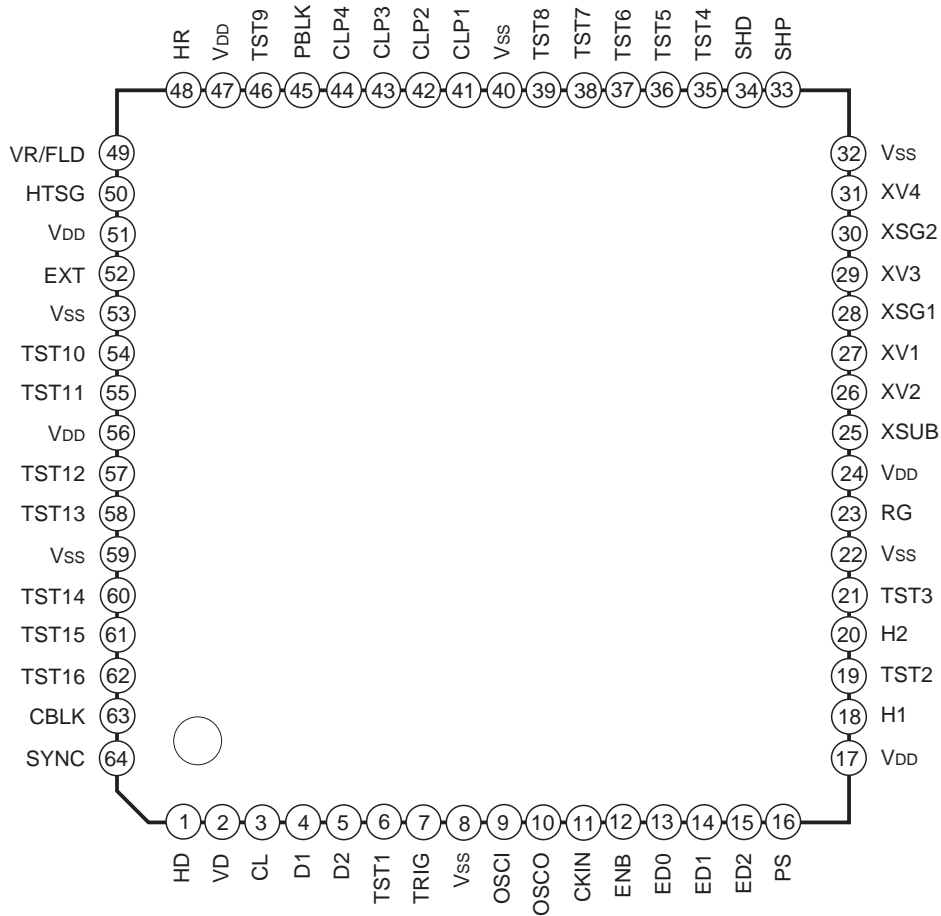

Mode name	Pin No.	PRESET	L	H
D1	4	L	EIA	CCIR
D2	5	L	Field readout	Frame readout
ENB	12	H	Normal	Shutter
ED0	13	H	Shutter speed	
ED1	14	H		
ED2	15	H		
PS	16	H	Serial input	Parallel input
EXT	52	L	Internal	External
TST1	6	—	Normally High	
TST13	58	—	Normally Low	

Note) Normally open for TST except as shown in the above table.

* During frame accumulation (readout), low-speed shutter does not operate normally.

Pin Description

Pin No.	Symbol	I/O	Description
1	HD	O	Horizontal drive pulse
2	VD	O	Vertical drive pulse
3	CL	O	CKIN 2 frequency divided output (EIA: 14.318MHz, CCIR: 14.1875MHz)
4	D1	I	Mode switching; low: EIA; high: CCIR (with pull-down resistor)
5	D2	I	Mode switching; low: field readout; high: frame readout* (with pull-down resistor)
6	TST1	I	Test input, fixed to high
7	TRIG	I	Shutter speed setting pulse (with pull-up resistor)
8	V _{SS}	—	GND
9	OSCI	I	Oscillating cell input
10	OSCO	O	Oscillating cell output
11	CKIN	I	Clock input (EIA: 28.636MHz, CCIR: 28.375MHz)
12	ENB	I	Shutter switching; low: normal; high: shutter (with pull-up resistor)
13	ED0	I	Shutter speed control (with pull-up resistor)
14	ED1	I	Shutter speed control (with pull-up resistor)
15	ED2	I	Shutter speed control (with pull-up resistor)
16	PS	I	Shutter speed setting method switching; low: serial; high: parallel (with pull-up resistor)
17	V _{DD}	—	Power supply
18	H1	O	Horizontal register drive clock
19	TST2	I	Test input, normally open (with pull-down resistor)
20	H2	O	Horizontal register drive clock
21	TST3	I	Test input, normally open (with pull-down resistor)
22	V _{SS}	—	GND
23	RG	O	Reset gate pulse
24	V _{DD}	—	Power supply
25	XSUB	O	Discharge pulse
26	XV2	O	Vertical register drive clock
27	XV1	O	Vertical register drive clock
28	XSG1	O	Sensor charge readout pulse
29	XV3	O	Vertical register drive clock
30	XSG2	O	Sensor charge readout pulse
31	XV4	O	Vertical register drive clock
32	V _{SS}	—	GND

* The CCD image sensor characteristics are guaranteed for field accumulation operation.

Pin No.	Symbol	I/O	Description
33	SHP	O	Precharge level sample-and-hold pulse
34	SHD	O	Data sample-and-hold pulse
35	TST4	O	Test output, normally open
36	TST5	O	Test output, normally open
37	TST6	O	Test output, normally open
38	TST7	O	Test output, normally open
39	TST8	O	Test output, normally open
40	V _{SS}	—	GND
41	CLP1	O	Clamp pulse
42	CLP2	O	Clamp pulse
43	CLP3	O	Clamp pulse
44	CLP4	O	Clamp pulse
45	PBLK	O	Blanking cleaning pulse
46	TST9	O	Test output, normally open
47	V _{DD}	—	Power supply
48	HR	I	H reset pulse
49	VR/FLD	I	V reset pulse (FLD output when EXT = low)
50	HTSG	I	HTSG input; low: XSG1, 2 on; high: off (valid only when EXT = low) Fixed to low when EXT = high
51	V _{DD}	—	Power supply
52	EXT	I	Sync mode switching; low: internal; high: external sync (with pull-down resistor)
53	V _{SS}	—	GND
54	TST10	I	Test input, normally open (with pull-down resistor)
55	TST11	O	Test output, normally open
56	V _{DD}	—	Power supply
57	TST12	O	Test output, normally open
58	TST13	I	Test input, fixed to low
59	V _{SS}	—	GND
60	TST14	O	Test output, normally open
61	TST15	O	Test output, normally open
62	TST16	O	Test output, normally open
63	CBLK	O	Composite blanking pulse
64	SYNC	O	Composite sync pulse

Block Diagram

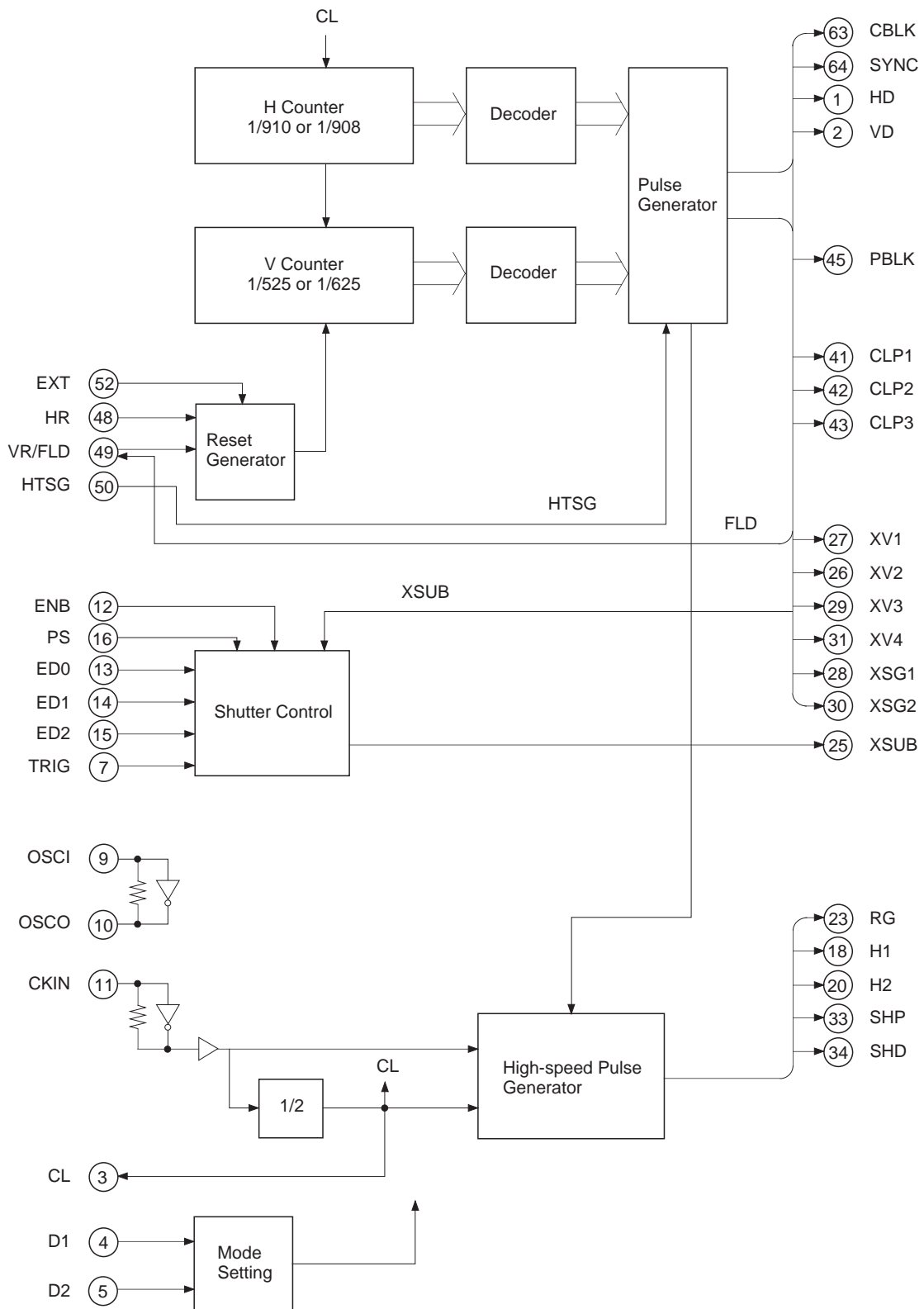

Electrical Characteristics

1) DC characteristics

(V_{DD} = 5V ± 0.25V, T_{opr} = -20 to +75°C)

Item	Symbol	Conditions	Min.	Typ.	Max.	Unit
Supply voltage	V _{DD}		4.75	5.0	5.25	V
Input voltage	V _{IH1}		0.7V _{DD}			V
	V _{IL1}				0.3V _{DD}	V
Output voltage 1 *1	V _{OH1}	I _{OH} = -2mA	V _{DD} - 0.5			V
	V _{OL1}	I _{OL} = 4mA			0.4	V
Output voltage 2 *2	V _{OH2}	I _{OH} = -4mA	V _{DD} - 0.5			V
	V _{OL2}	I _{OL} = 8mA			0.4	V
Output voltage 3 *3	V _{OH3}	I _{OH} = -8mA	V _{DD} - 0.5			V
	V _{OL3}	I _{OL} = 8mA			0.4	V
Output voltage 4 *4	V _{OH4}	I _{OH} = -2mA	V _{DD} /2			V
	V _{OL4}	I _{OL} = 2mA			V _{DD} /2	V
Feedback resistor	R _{FB}	V _{IN} = V _{SS} or V _{DD}	500K	2M	5M	Ω
Pull-up resistor	R _{PU}	V _{IL} = 0V	40K	100K	250K	Ω
Pull-down resistor	R _{PD}	V _{IH} = V _{DD}	40K	100K	250K	Ω

2) I/O pin capacitance

(V_{DD} = V_I = 0V, f_M = 1MHz)

Item	Symbol	Min.	Typ.	Max.	Unit
Input pin capacitance	C _{IN}			9	pF
Output pin capacitance	C _{OUT}			11	pF
Input/output pin capacitance	C _{I/O}			11	pF

Note) *1 CLP1, CLP2, CLP3, CLP4, PBLK, CBLK, SYNC, VR, HD, VD, XSUB, XSG1, XSG2, XV1, XV2, XV3, XV4

*2 CL, RG, SHP, SHD

*3 H1, H2

*4 OSCO

External Reset Description

H Reset (HR)

The reset is performed at the first falling edge of the reset pulse that was input; resets are not performed at subsequent edges as long as they do not deviate by two clock pulses (0.14μs) or more.

The minimum reset pulse width is 0.35μs. In addition, HD immediately after a reset can not be guaranteed. The position at which the reset is performed is 2.31μs advanced after the H reset input.

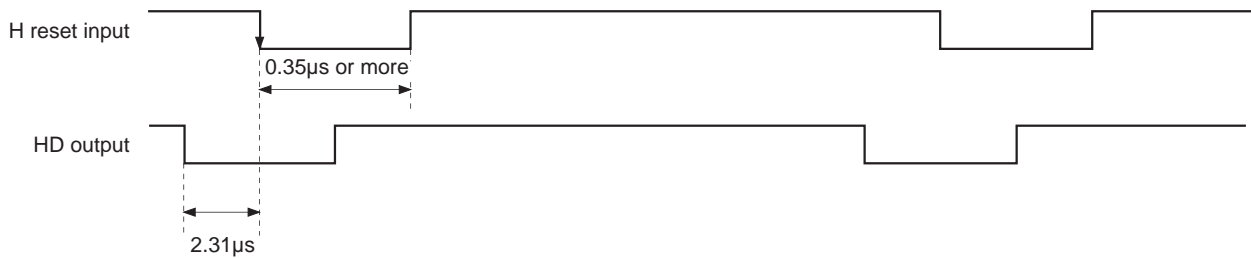

V Reset (VR)

The falling edge of V reset pulse that was input is field identified by the phase difference with the internal signal (field judge pulse) defined by the falling edge of HD. And VD is reset in phase with V reset pulse.

When field judge pulse is low and V reset pulse falls,

EIA: VD falling edge after 262.5H is the relation between HD and VD of EVEN field.

CCIR: VD falling edge after 313.5H is the relation between HD and VD of ODD field.

Also, when field judge pulse is high and V reset pulse falls,

EIA: VD falling edge after 262.5H is the relation between HD and VD of ODD field.

CCIR: VD falling edge after 313.5H is the relation between HD and VD of EVEN field.

The minimum reset pulse width is 64μs.

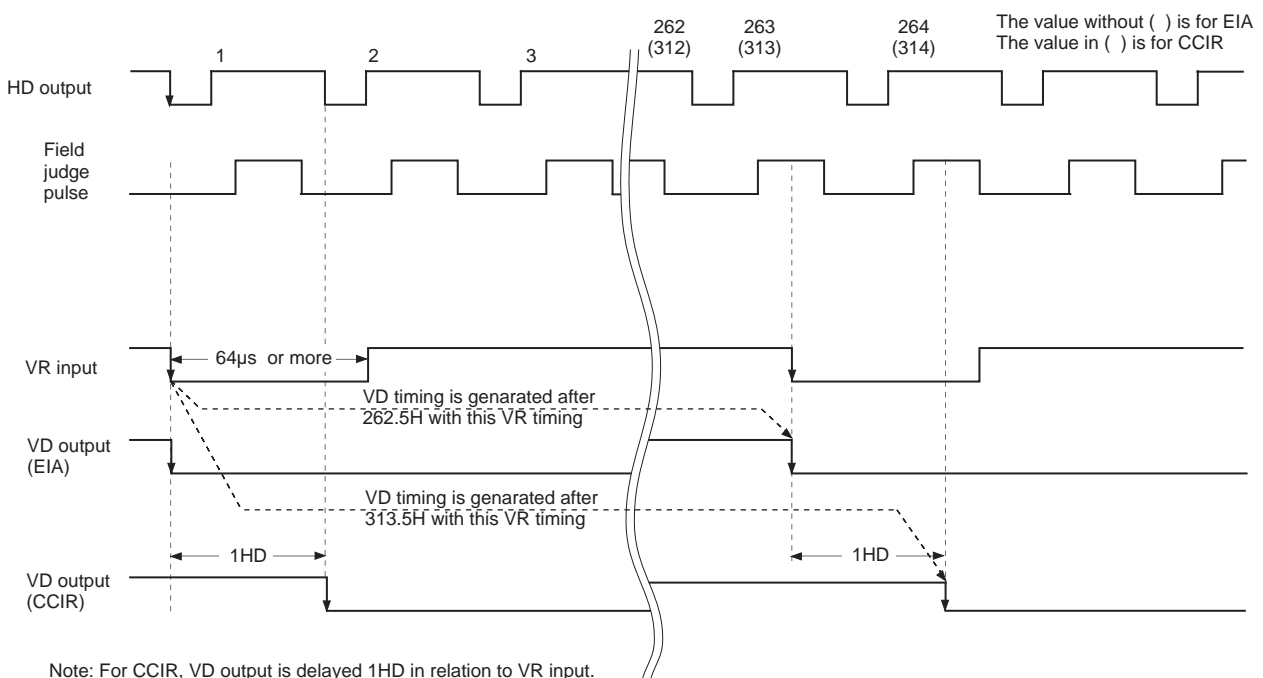

Electronic Shutter Description (During frame accumulation, low-speed shutter does not operate normally.)
The XSUB pulse timing changes according to the electronic shutter control described below. In addition, the ENB pin controls whether the XSUB pulse is output or not; this control has priority.

1. Continuously variable shutter (trigger mode)

- When using the normal shutter, either leave the TRIG pin open or connect it to the power supply.
- When using the continuous variable shutter, input the clock pulse to the TRIG pin.

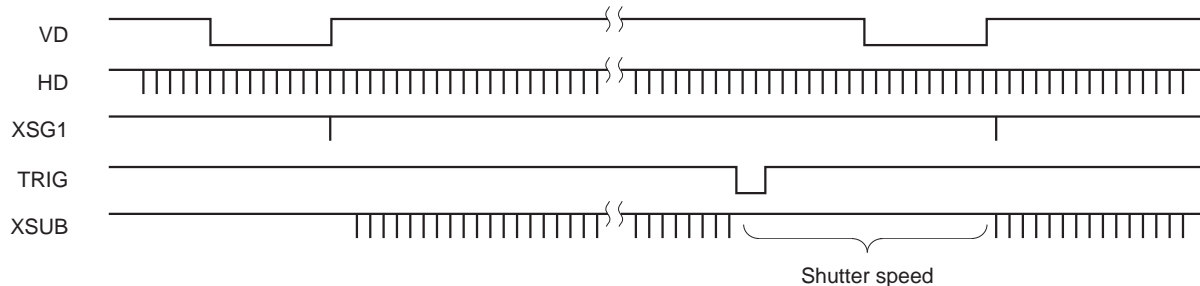

The shutter speed is determined by sampling the XSUB pulse during the interval between the falling edge of XSG1 and the falling edge of TRIG, and then stopping the XSUB pulse during the interval between the falling edge of TRIG and the next falling edge of XSG1.

When using the TRIG pin to control the shutter speed, in order to broaden the control range it is necessary to use the ED0, 1, and 2 pins (described later) to set the shutter speed to 1/10000.

2. Normal shutter

2-1. Switching between parallel input and serial input

Parallel input or serial input can be selected as the method for inputting the data used to determine the shutter speed.

- Parallel input (PS = High):
Permits selection of eight shutter speeds by using three bits ED0, ED1, and ED2.
- Serial input (PS = Low):
Shutter speed is determined by inputting the strobe to ED0, CLK to ED1, and the data to ED2.

2-2. When using parallel input (PS = High)

Shutter speed table

Only the high-speed shutter is used when using parallel input (During frame accumulation, low-speed shutter does not operate normally.)

D1	ENB	ED0	ED1	ED2	Shutter speed
X	L	X	X	X	Shutter off *1
L	H	H	H	H	1/60 (s) *2
H	H	H	H	H	1/50 (s) *2
L	H	L	H	H	1/100 (s)
H	H	L	H	H	1/120 (s)
X	H	H	L	H	1/250 (s)
X	H	L	L	H	1/500 (s)
X	H	H	H	L	1/1000 (s)
X	H	L	H	L	1/2000 (s)
X	H	H	L	L	1/4000 (s)
X	H	L	L	L	1/10000 (s)

*1 XSUB (shutter pulse) is not generated.
 *2 Accumulation time is as follows regardless of field accumulation/frame accumulation.
 D1 = Low (EIA), 1/60 (s)
 D2 = High (CCIR), 1/50 (s)
 (Pseudo field readout during frame accumulation.)

2-3. When using serial input (PS = Low)

The following four modes can be selected according to the combination of serial data SMD1 and SMD2. (During frame accumulation, low-speed shutter does not operate normally.)

Shutter mode

Mode	Flickerless	High-speed shutter	Low-speed shutter	No shutter
SMD1	L	L	H	H
SMD2	L	H	L	H

- Flickerless: Eliminates flicker resulting from the frequency of fluorescent light
- High-speed shutter: Higher speed shutter than 1/60 (EIA), 1/50 (CCIR)
- Low-speed shutter: Lower speed shutter than 1/60 (EIA), 1/50 (CCIR)
(Does not operate normally during frame accumulation.)
- No shutter: No shutter operation

<Input timing when using serial input>

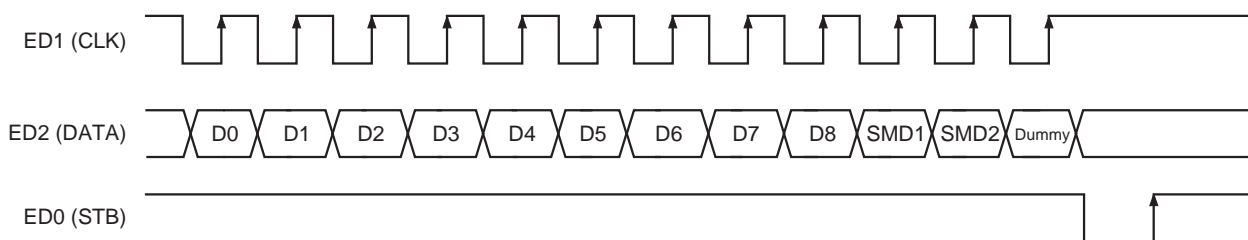

The data on ED2 is latched in the register at the rising edge of ED1 and is then taken in internally while ED0 is low.

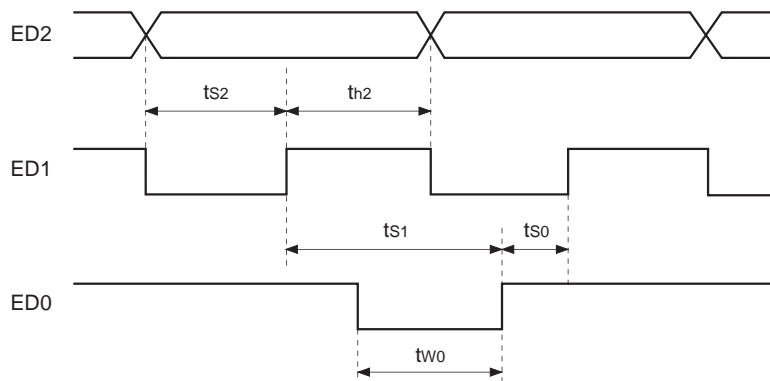

Symbol		Min.	Max.
ts2	ED2 setup time against the rising edge of ED1	20ns	—
th2	ED2 hold time against the rising edge of ED1	20ns	—
ts1	ED1 rising setup time against the rising edge of ED0	20ns	—
tw0	ED0 pulse width	20ns	50μs
ts0	ED0 rising setup time against the rising edge of ED1	20ns	—

<Shutter speed calculation> (During frame accumulation, low-speed shutter does not operate normally.)

High-speed shutter

- For EIA

$$T = [262_{10} - (1FF_{16} - L_{16})] \times 63.56 + 34.78\mu s \quad * L_{16}: \text{load value}$$

- For CCIR

$$T = [312_{10} - (1FF_{16} - L_{16})] \times 64 + 35.6\mu s$$

EIA			CCIR		
Load value	Shutter speed	Calculated value	Load value	Shutter speed	Calculated value
0FA ₁₆	1/10000	1/10169	0C8 ₁₆	1/1000	1/10040
0FC ₁₆	1/4000	1/4435	0CA ₁₆	1/4000	1/4394
100 ₁₆	1/2000	1/2085	0CE ₁₆	1/2000	1/2068
108 ₁₆	1/1000	1/1012	0D6 ₁₆	1/1000	1/1004
118 ₁₆	1/500	1/499	0E6 ₁₆	1/500	1/495
137 ₁₆	1/250	1/252	105 ₁₆	1/250	1/250
176 ₁₆	1/125	1/125	143 ₁₆	1/125	1/125
196 ₁₆	1/100	1/100	149 ₁₆	1/100	1/120

Low-speed shutter (Does not operate normally during frame accumulation.)

$$N = 2 \times (1FF_{16} - L_{16}) \quad \text{FLD}$$

However, 1FF cannot be used as the load value.

Load value	Shutter speed (FLD)
1FE ₁₆	2
1FD ₁₆	4
:	:
101 ₁₆	508
100 ₁₆	510

Timing Chart (EIA)

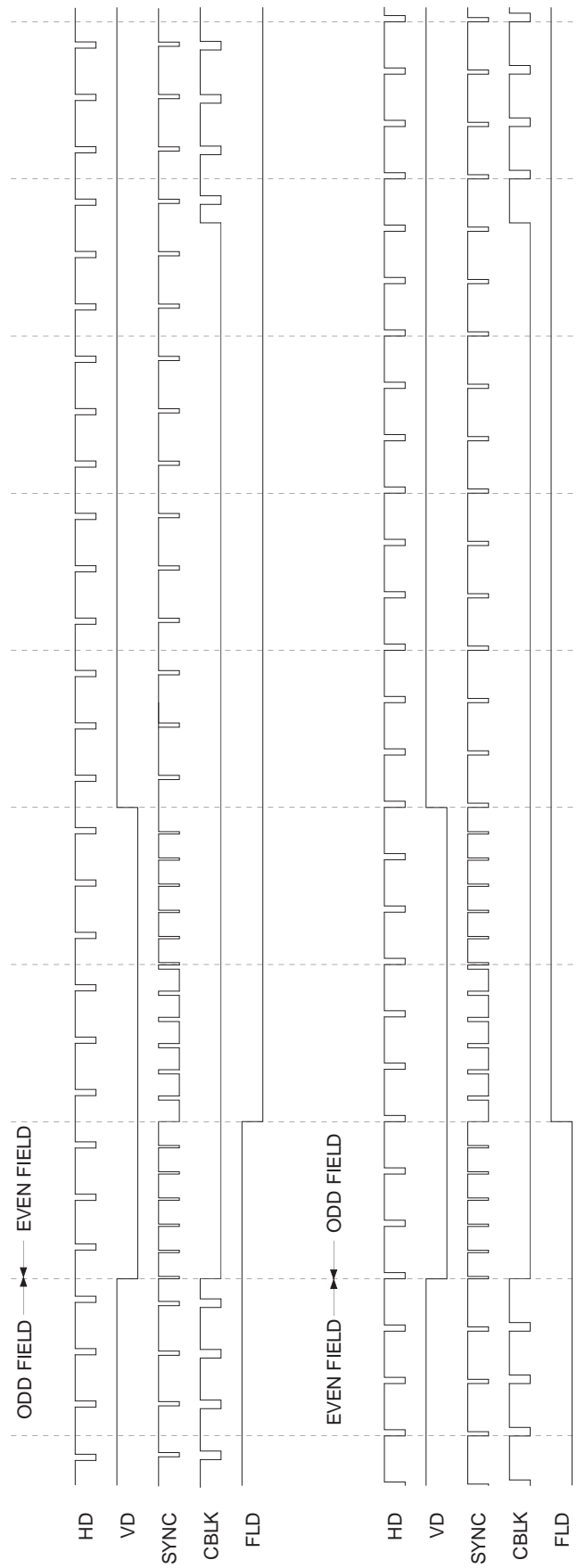

Timing Chart (CCIR)

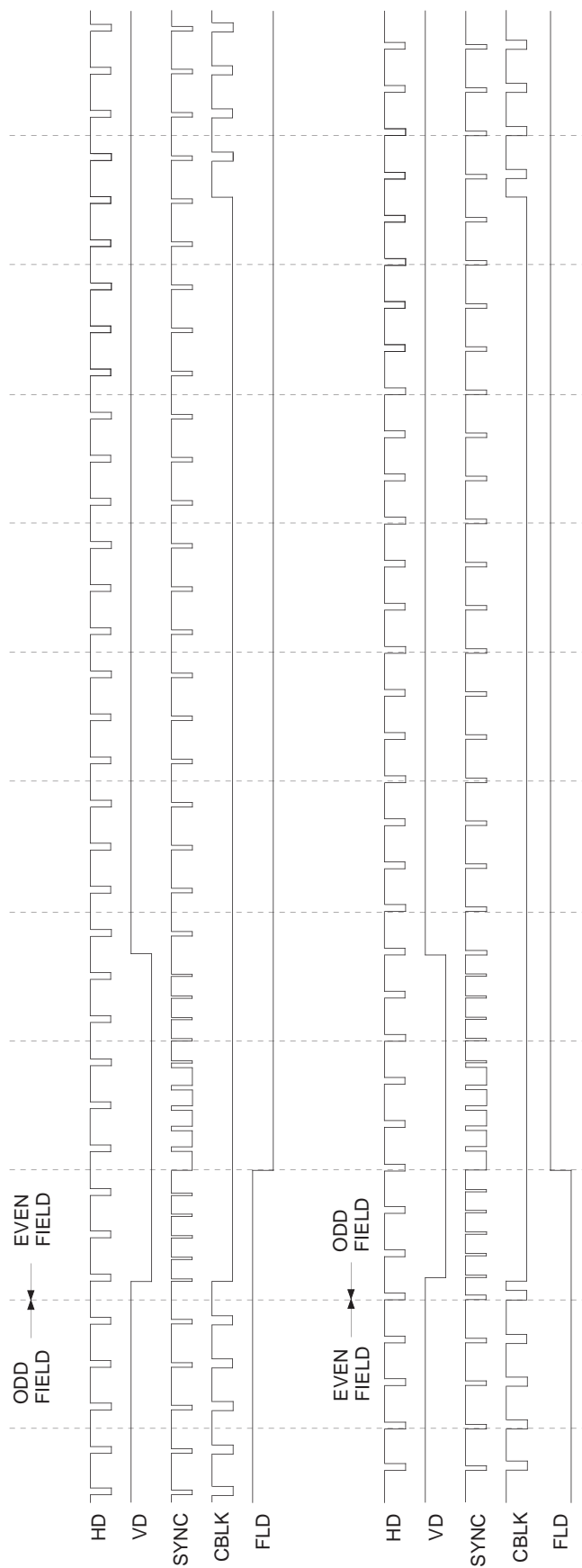

Timing Chart (EIA)

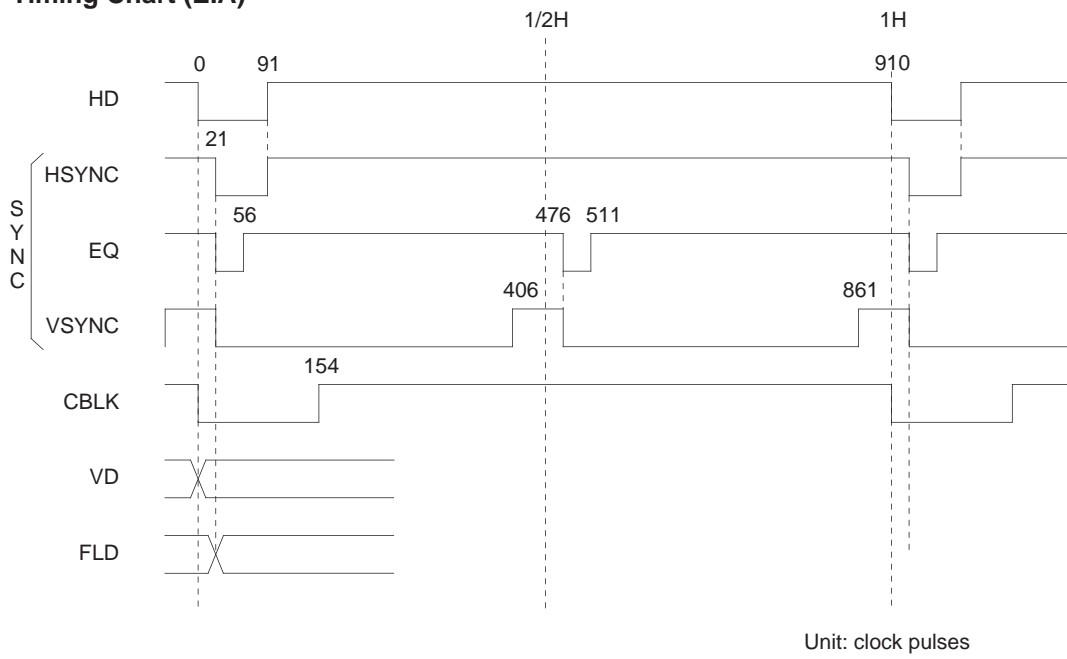

Timing Chart (CCIR)

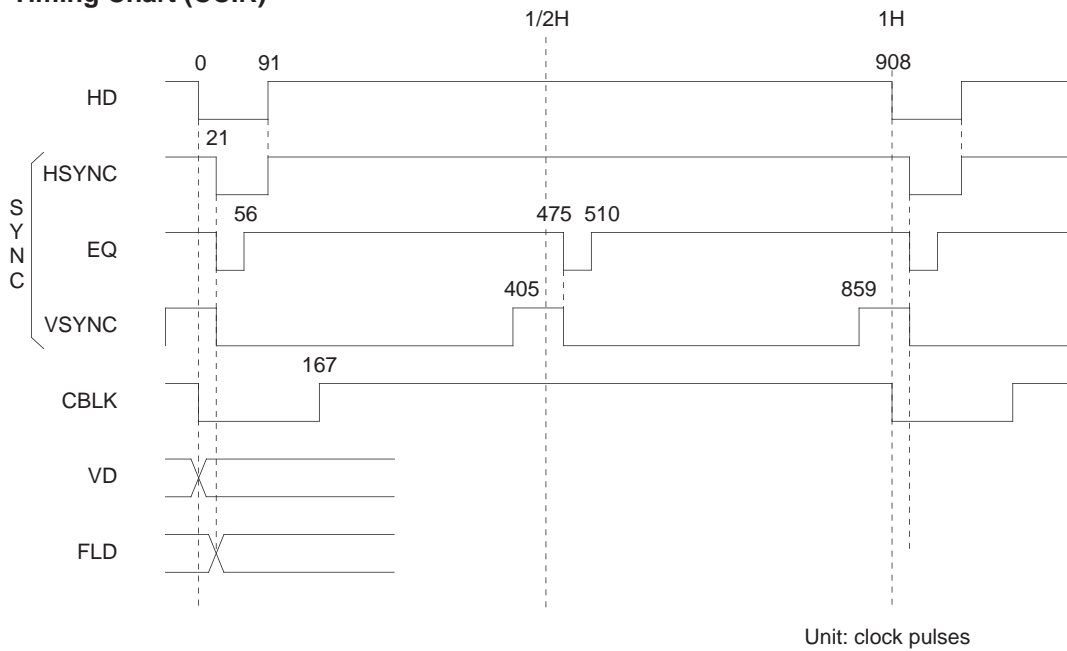

Timing Chart (EIA vertical direction)
 ODD Field

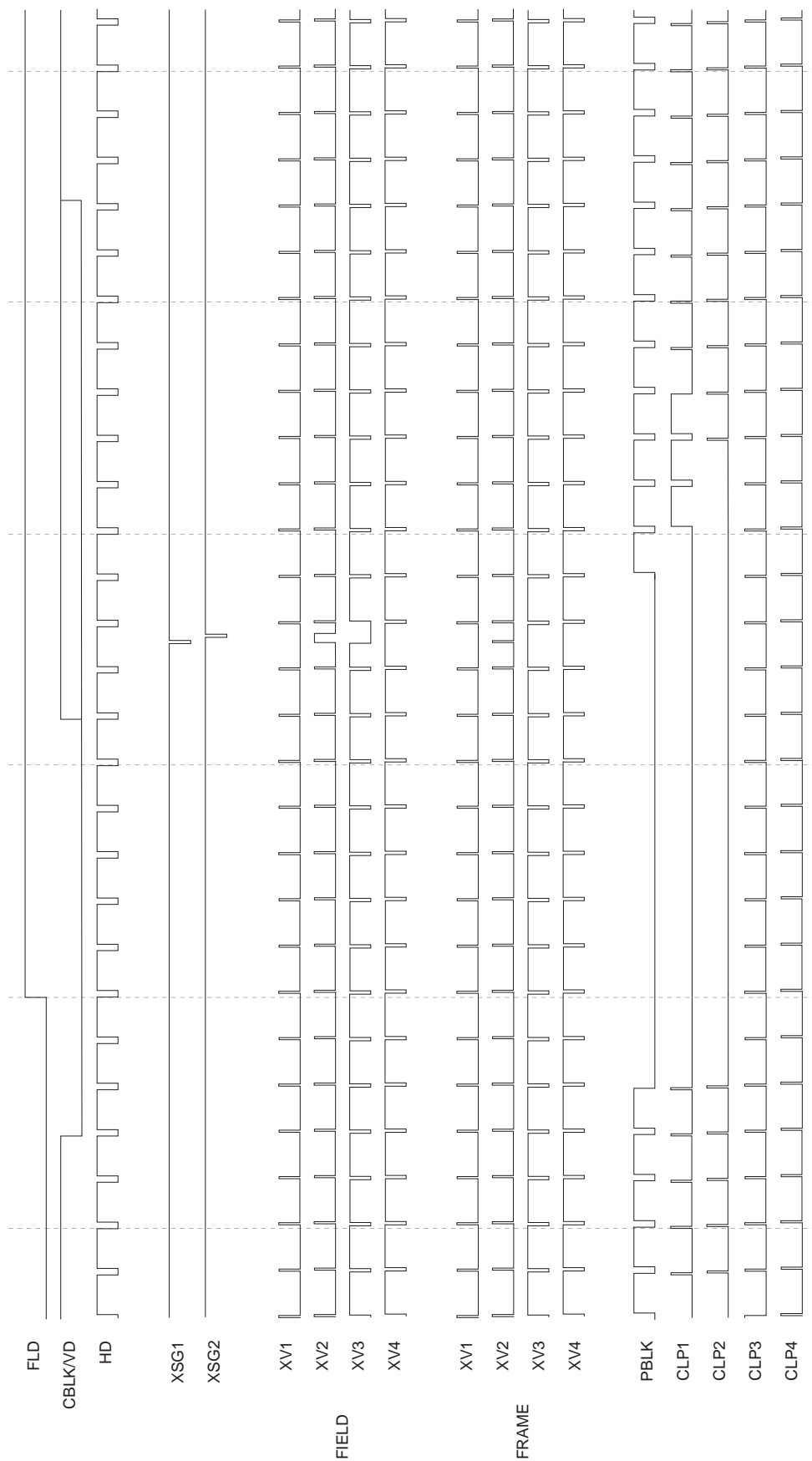

Timing Chart (EIA vertical direction)
EVEN Field

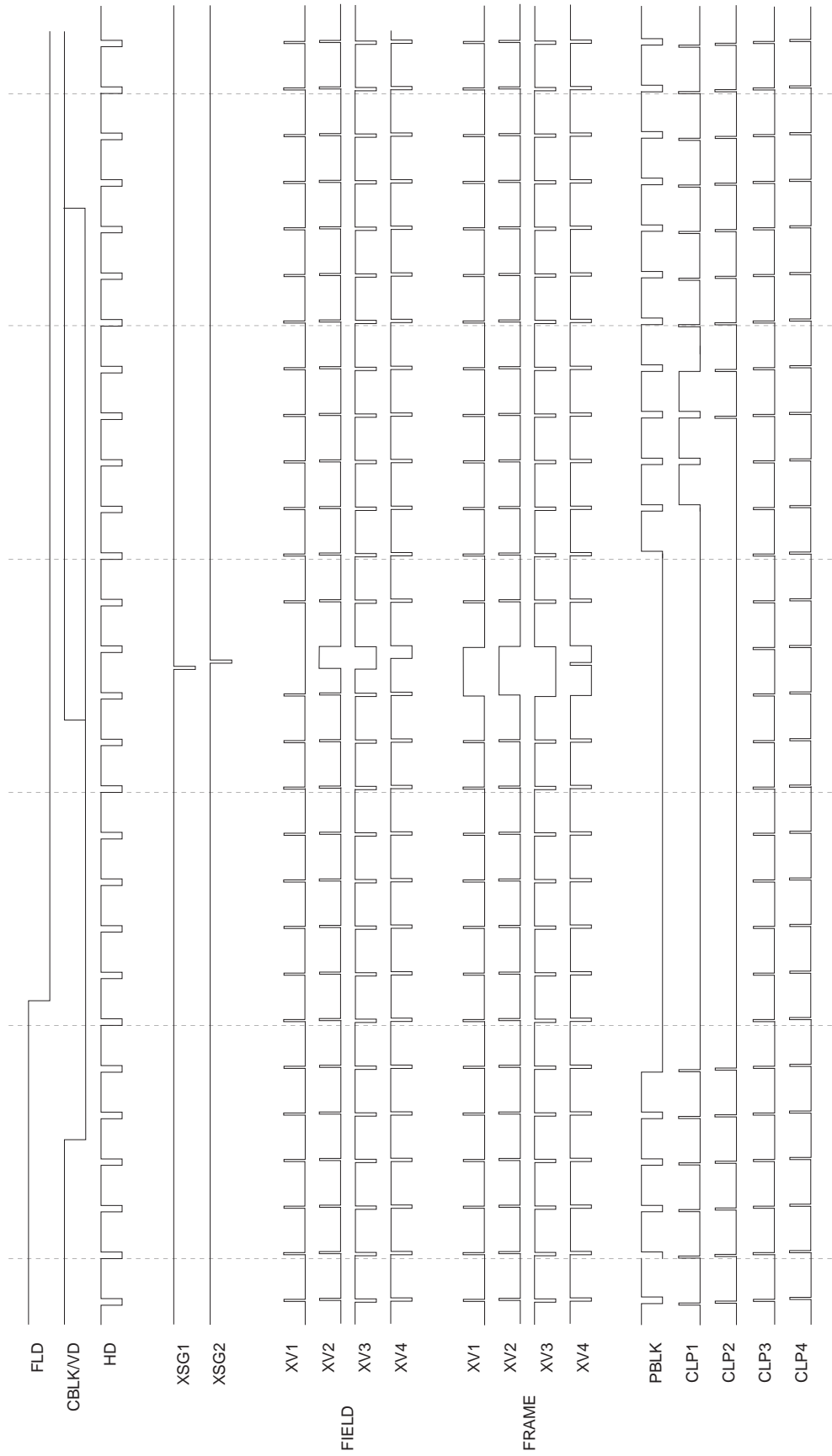

Timing Chart (CCIR vertical direction)
 ODD Field

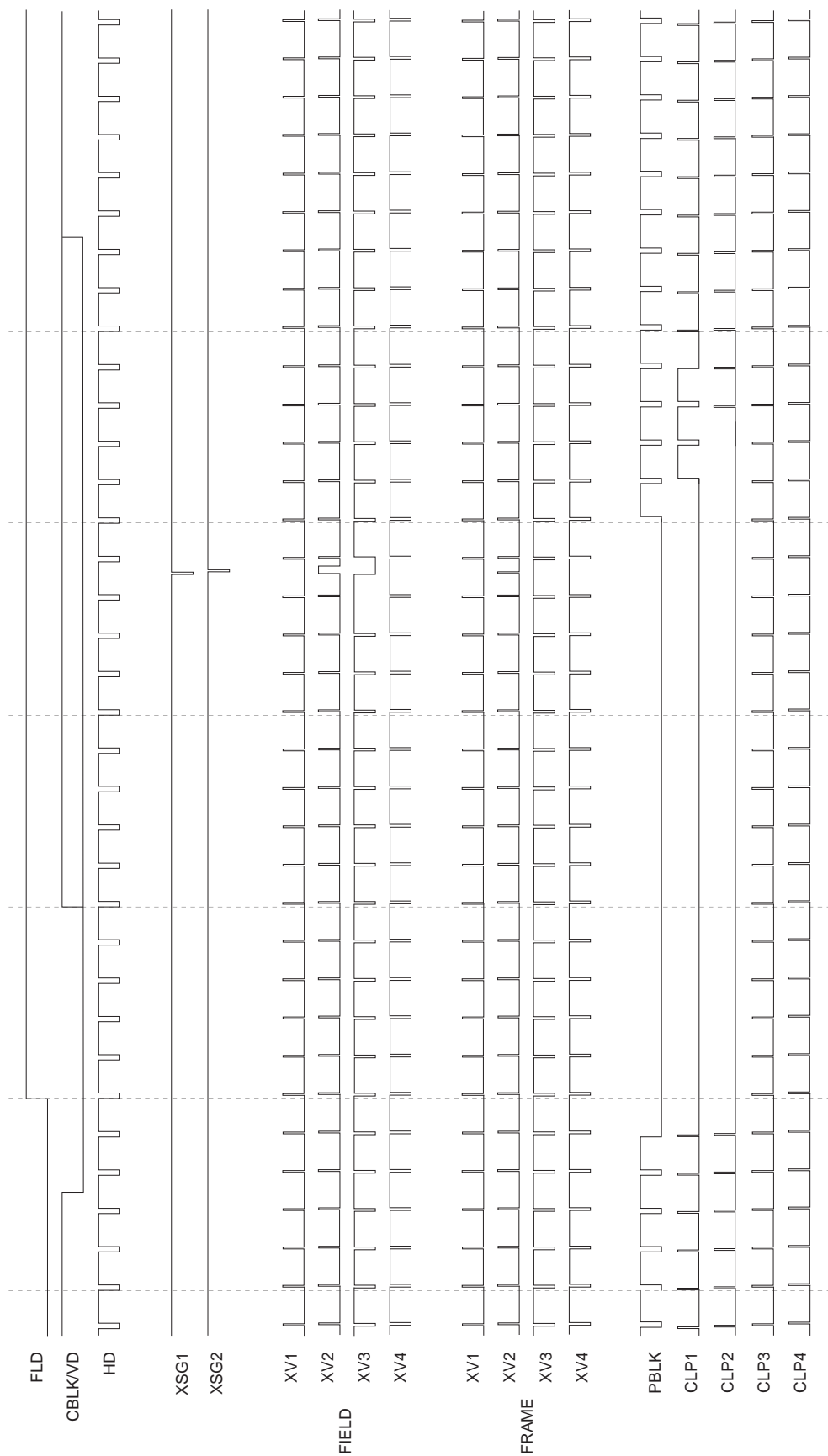

Timing Chart (CCIR vertical direction)
EVEN Field

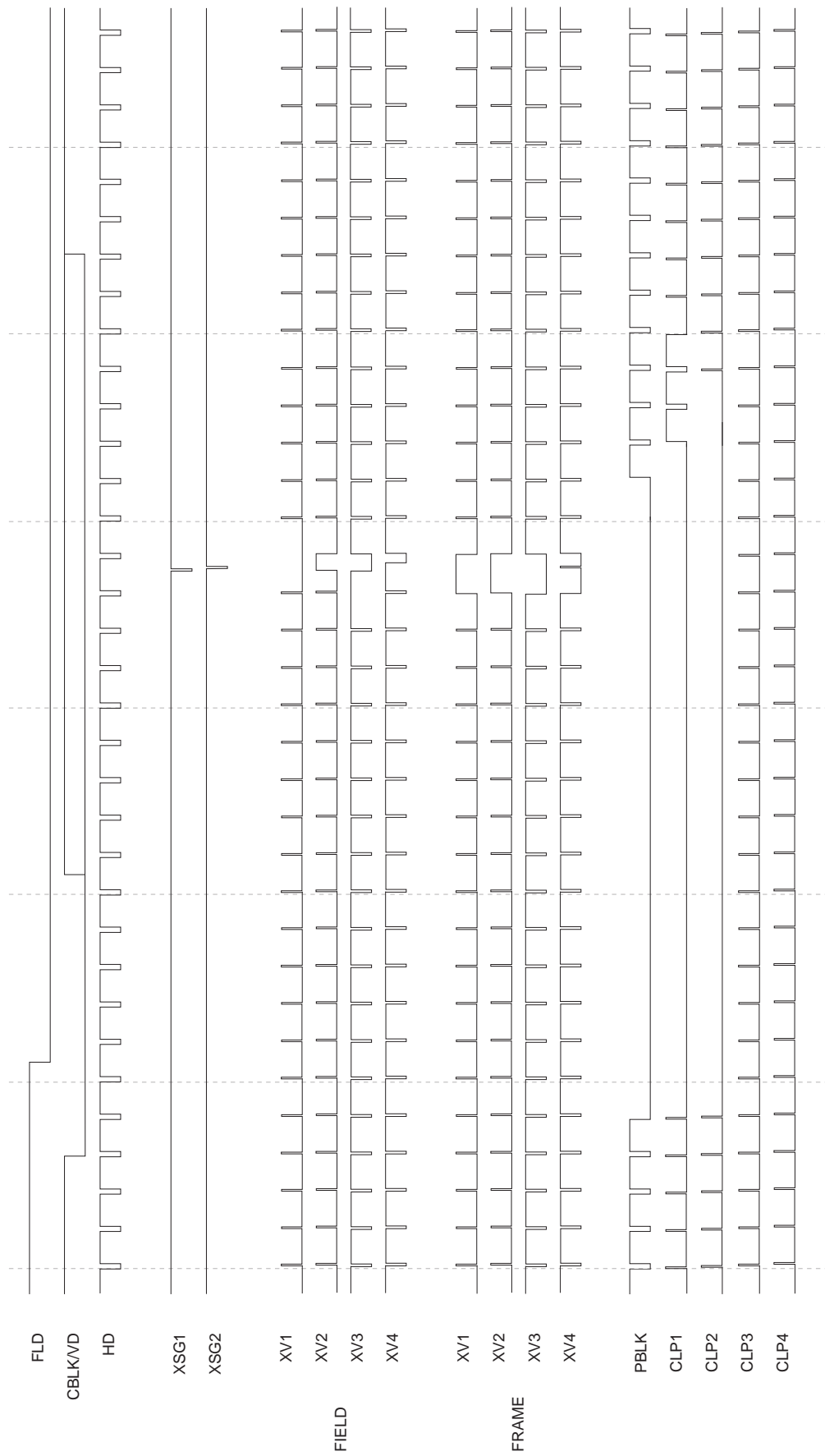

Timing Chart (EIA horizontal direction)

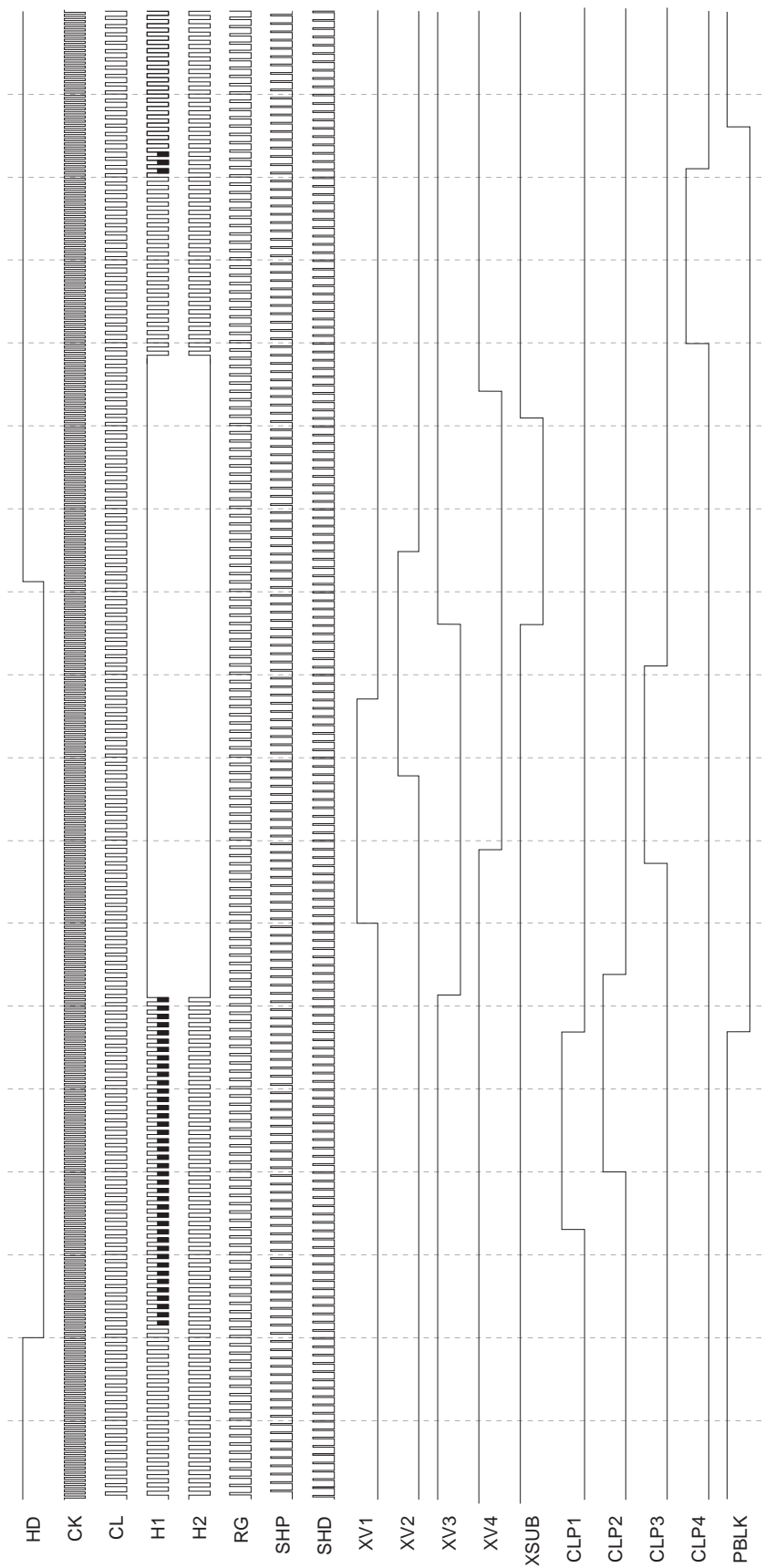

The black-pointed sections of the H1 clock indicate the optical black.

Timing Chart (CCIR horizontal direction)

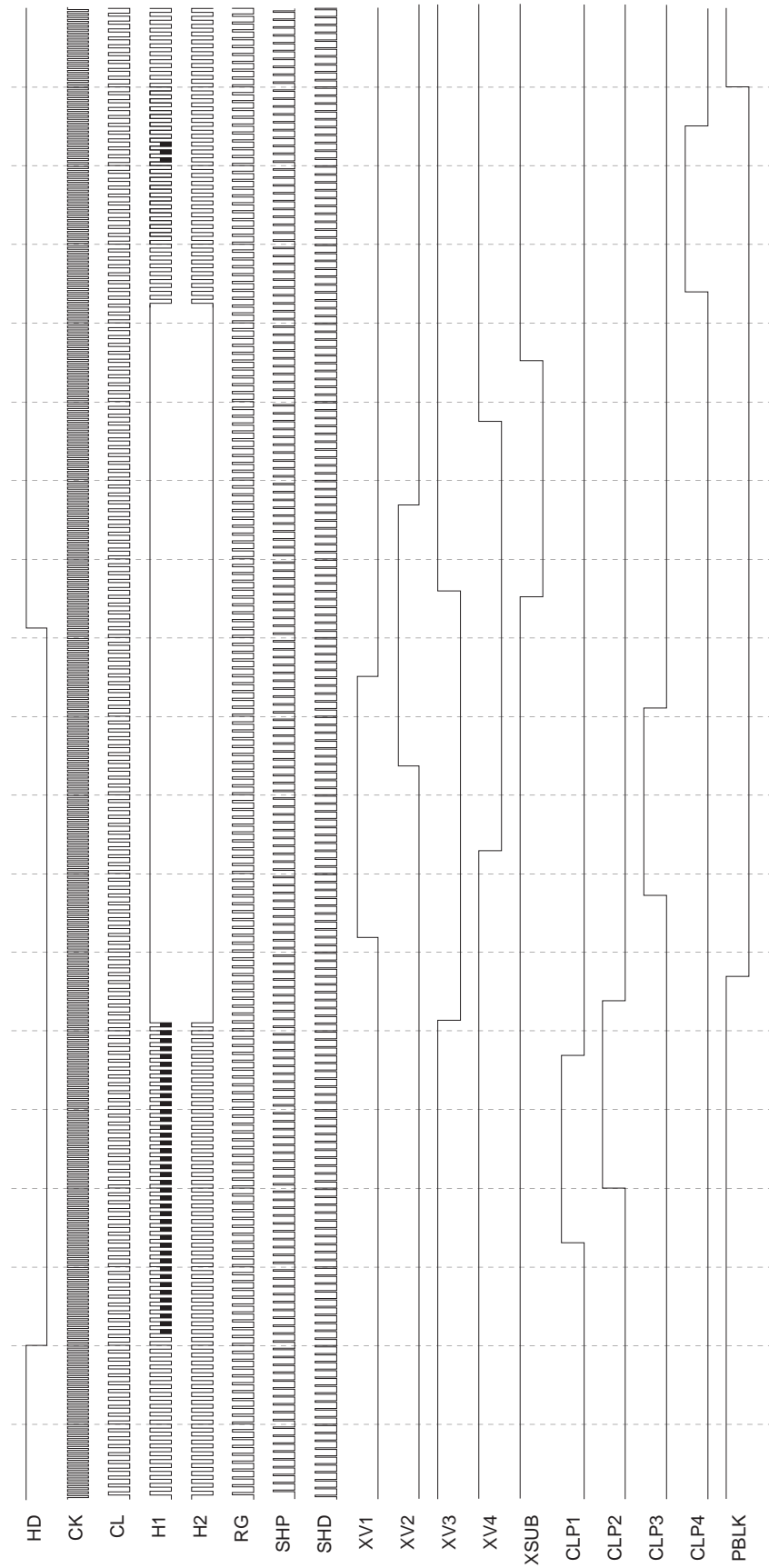

The black-pointed sections of the H1 clock indicate the optical black.

Readout Timing Chart (EIA)

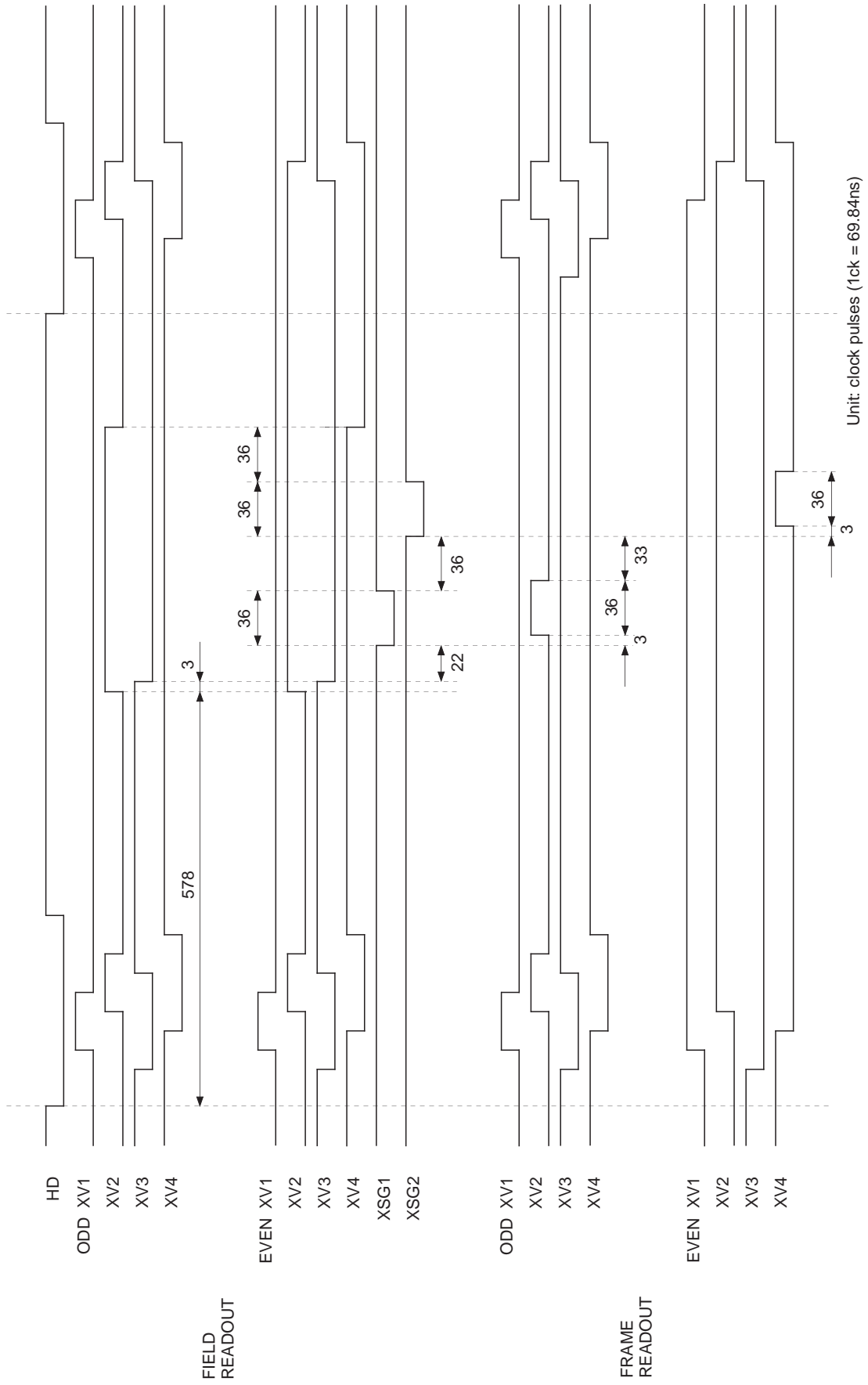

Readout Timing Chart (CCIR)

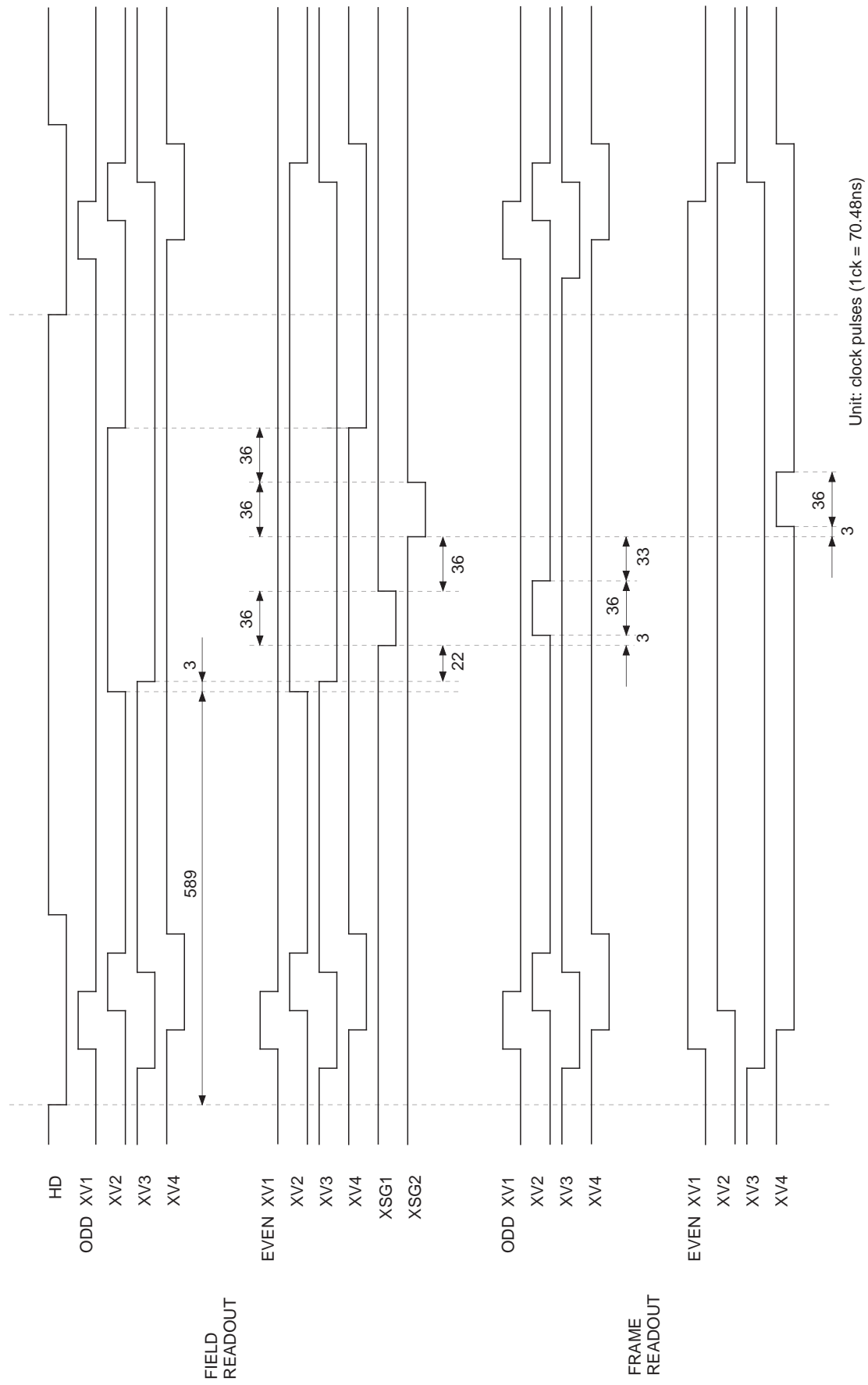

Timing Chart (High-speed phase)

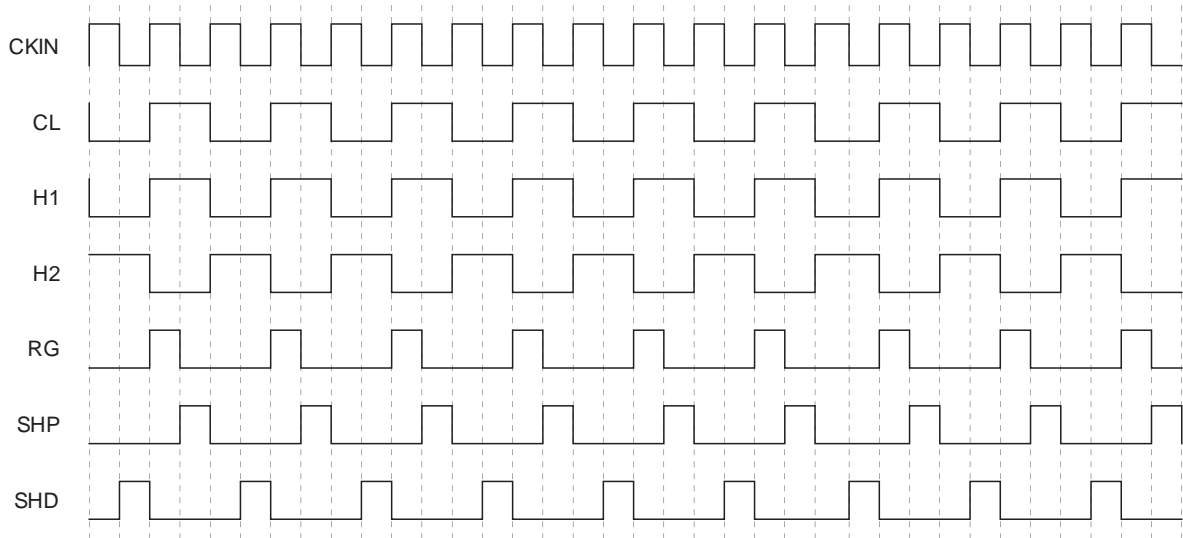

Application Circuit

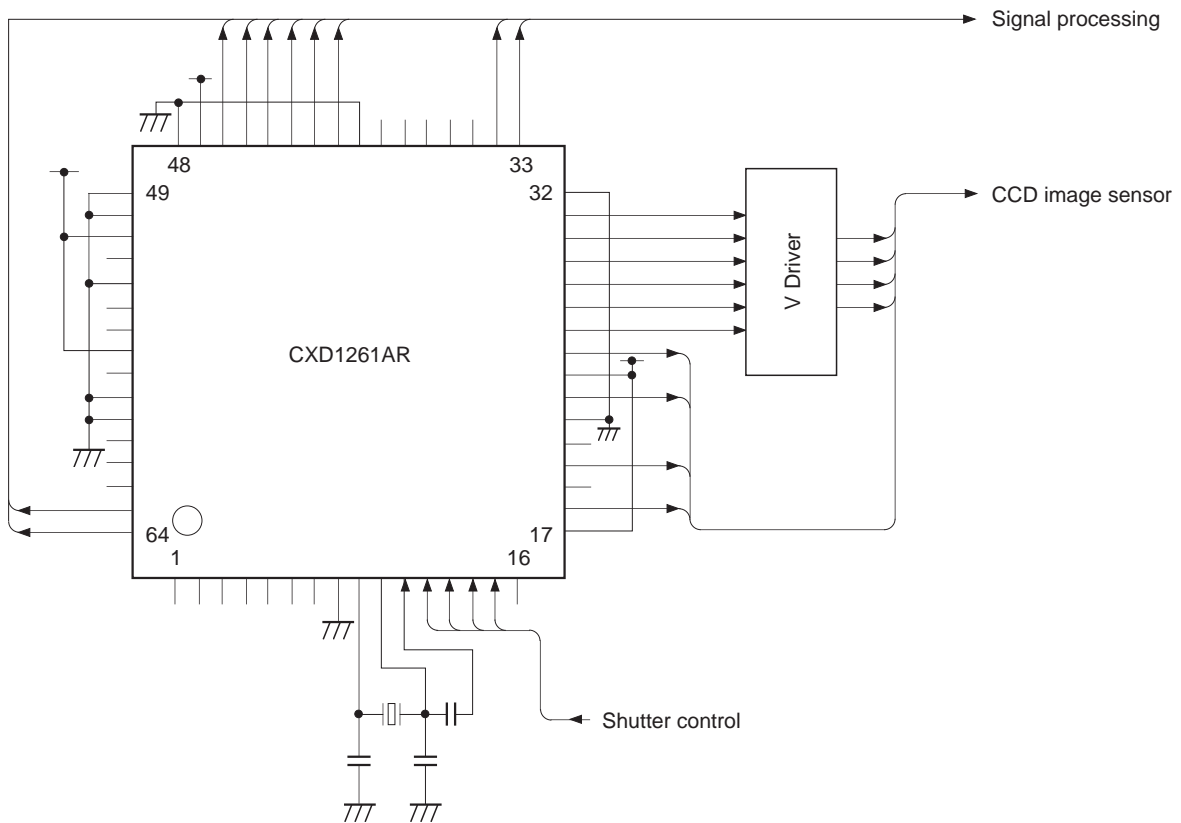

OSC EIA : 28.6363MHz
 CCIR : 28.375MHz

* Use a crystal that operates with a fundamental wave.

Application circuits shown are typical examples illustrating the operation of the devices. Sony cannot assume responsibility for any problems arising out of the use of these circuits or for any infringement of third party patent and other right due to same.

Package Outline

Unit: mm

64PIN LQFP (PLASTIC)

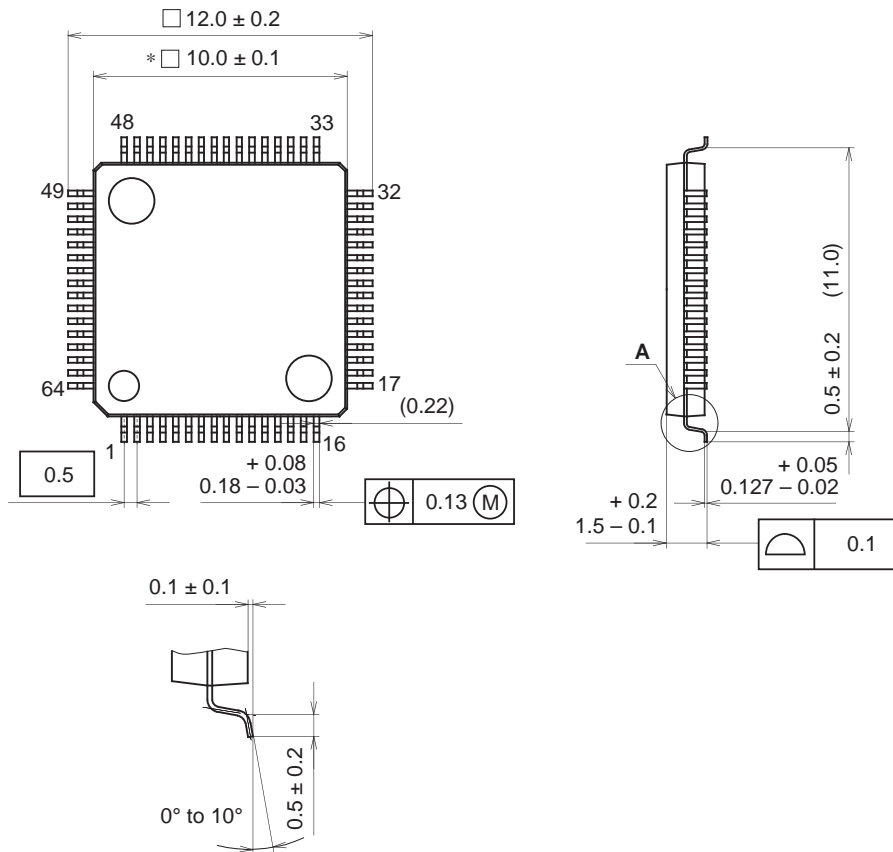

NOTE: Dimension "*" does not include mold protrusion.

DETAIL A

PACKAGE STRUCTURE

SONY CODE	LQFP-64P-L01
EIAJ CODE	LQFP064-P-1010
JEDEC CODE	_____

PACKAGE MATERIAL	EPOXY RESIN
LEAD TREATMENT	SOLDER/PALLADIUM PLATING
LEAD MATERIAL	42/COPPER ALLOY
PACKAGE MASS	0.3g