

S G S-THOMSON
TRIACS

- GLASS PASSIVATED CHIP
- HIGH SURGE CURRENT

DESCRIPTION

Low power triacs suited for 50 and 60 Hz up to 380 V_{RMS}.

APPLICATIONS

- CONTROL SPEED FOR LITTLE MOTORS ;
ELECTRIC PUMP OR VENTILATOR, SEWING MACHINE
- RELAY, DETECTOR, ALARM SYSTEM
- ELECTRONIC STARTER FOR LAMP
- HIGH POWER TRIAC DRIVER

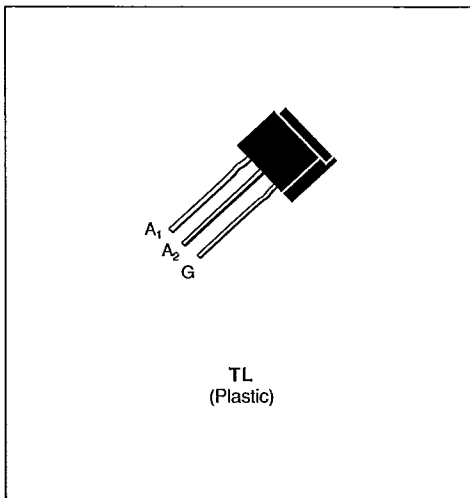
ABSOLUTE RATINGS (limiting values)

Symbol	Parameter	Value	Unit
$I_{T(RMS)}$	RMS on-state Current (360° conduction angle)	$T = 40\text{ °C}$	1 A
$I_{T(RMS)}$	RMS on-state Current on Printed Circuit (360° conduction angle)	$T_a = 25\text{ °C}$	0.77 A
I_{TSM}	Non Repetitive Surge Peak on-state Current (T_j initial = 25 °C - Half sine wave)	$t = 8.3\text{ ms}$	16 A
		$t = 10\text{ ms}$	15 A
I^2t	I^2t Value for Fusing	$t = 10\text{ ms}$	1.125 A ² s
di/dt	Critical Rate of Rise of on-state Current (1)	Repetitive	10 A/ μ s
T_{stg} T_j	Storage and Operating Junction Temperature Range	- 40 to 150 - 40 to 110	°C °C

Symbol	Parameter	TLC111B	TLC221B	TLC331B	TLC381B	Unit
V_{DRM}	Repetitive Peak off-state Voltage (2)	200	400	600	700	V

(1) $I_G = 500\text{ mA}$ $di_G/dt = 1\text{ A}/\mu\text{s}$
 (2) $T_j = 110\text{ °C}$.

THERMAL RESISTANCES

Symbol	Parameter	Value	Unit
R_{Tj-Ta}	Junction to Ambient on Printed Circuit	75	C/W
R_{Tj-l}	Junction-leads for 360° Conduction Angle ($F = 50\text{ Hz}$)	45	C/W

GATE CHARACTERISTICS (maximum values)

$P_{GM} = 2 \text{ W}$ ($t_p = 10 \mu\text{s}$)

$I_{GM} = 1 \text{ A}$ ($t_p = 10 \mu\text{s}$)

$P_{G(AV)} = 0.1 \text{ W}$

$V_{GM} = 16 \text{ V}$ ($t_p = 10 \mu\text{s}$)

T-25-13

ELECTRICAL CHARACTERISTICS

Symbol	Test Conditions	Quadrants	Min.	Typ.	Max.	Unit
I_{GT}	$T_j = 25 \text{ }^\circ\text{C}$ $V_D = 12 \text{ V}$ Pulse Duration > 20 μs	I-II-III			25	mA
		IV			50	
V_{GT}	$T_j = 25 \text{ }^\circ\text{C}$ $V_D = 12 \text{ V}$ Pulse Duration > 20 μs	I-II-III-IV			1.5	V
V_{GD}	$T_j = 110 \text{ }^\circ\text{C}$ $V_D = V_{DRM}$	$R_L = 3.3 \text{ k}\Omega$ I-II-III-IV		0.2		V
I_{H}^*	$T_j = 25 \text{ }^\circ\text{C}$ $I_T = 100 \text{ mA}$	Gate Open		8		mA
I_L	$T_j = 25 \text{ }^\circ\text{C}$ $V_D = 12 \text{ V}$ Pulse Duration > 20 μs	$I_G = 100 \text{ mA}$ I-II-III-IV		8		mA
V_{TM}^*	$T_j = 25 \text{ }^\circ\text{C}$ $I_{TM} = 1.4 \text{ A}$	$t_p = 10 \text{ ms}$			1.8	V
I_{DRM}^*	V_{DRM} Specified	$T_j = 25 \text{ }^\circ\text{C}$			0.01	mA
		$T_j = 110 \text{ }^\circ\text{C}$			0.75	
dv/dt^*	$T_j = 110 \text{ }^\circ\text{C}$ Gate Open Linear Slope up to $V_D = 67 \% V_{DRM}$		20			V/ μs
$(dv/dt)_c^*$	$T_j = 40 \text{ }^\circ\text{C}$ $V_D = V_{DRM}$ $(di/dt)_c = 0.4 \text{ A/ms}$	$I_T = 1.4 \text{ A}$	5			V/ μs
t_{gt}	$T_j = 25 \text{ }^\circ\text{C}$ $V_D = V_{DRM}$ $I_G = 100 \text{ mA}$ $di_G/dt = 1 \text{ A}/\mu\text{s}$	$I_T = 1.4 \text{ A}$ I-II-III-IV		3		μs

* For either polarity of electrode A_2 voltage with reference to electrode A_1 .

PACKAGE MECHANICAL DATA

TL Plastic

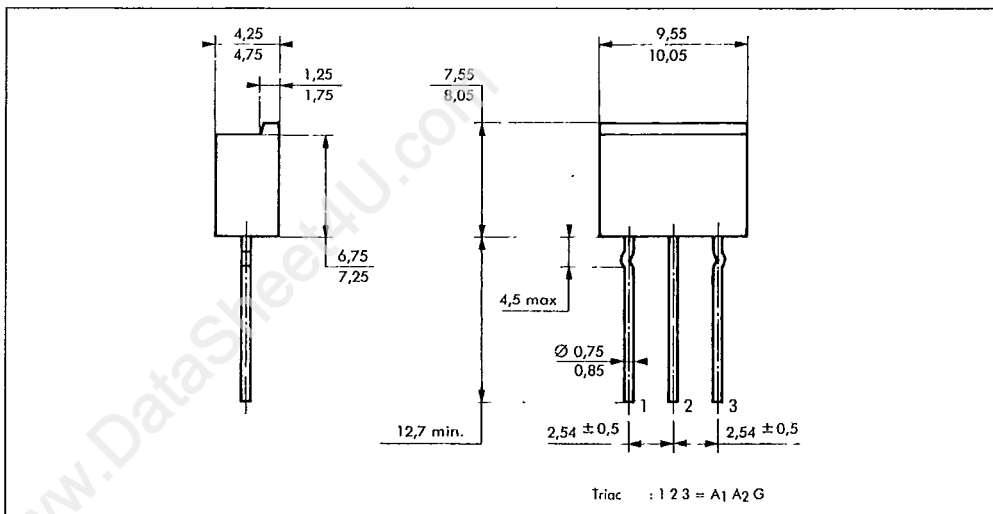

Cooling method : by convection (method A)

Marking : type number

Weight : 0.8 g.

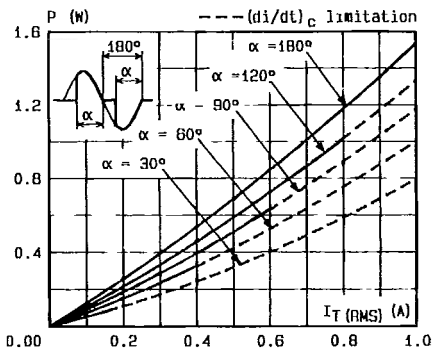

Fig. 1 - Maximum mean power dissipation versus RMS on-state current.

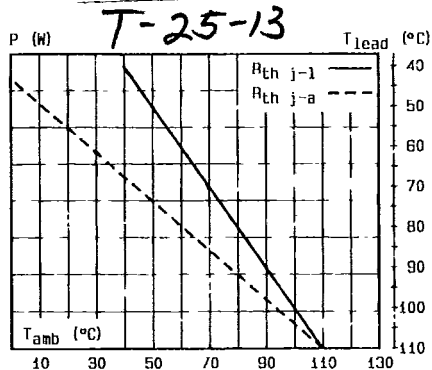

Fig. 2 - Correlation between maximum mean power dissipation and maximum allowable temperatures (T_{amb} and T_{lead}).

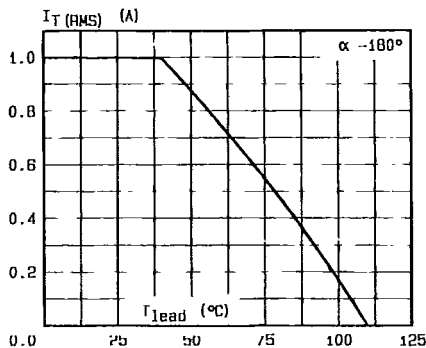

Fig. 3 - RMS on-state current versus lead temperature.

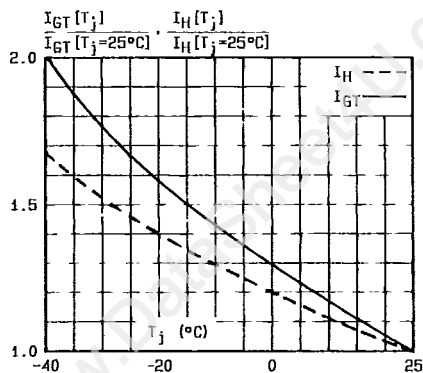

Fig. 5 - Relative variation of gate trigger current and holding current versus junction temperature.

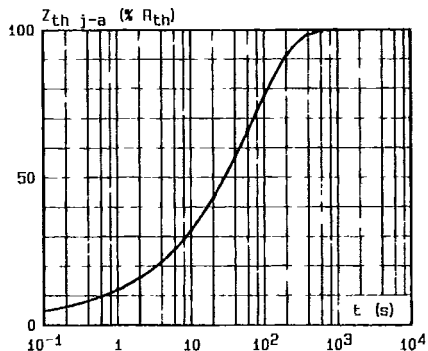

Fig. 4 - Thermal transient impedance junction to ambient versus pulse duration.

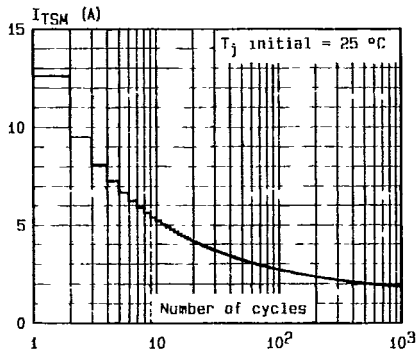

Fig. 6 - Non repetitive surge peak on-state current versus number of cycles.

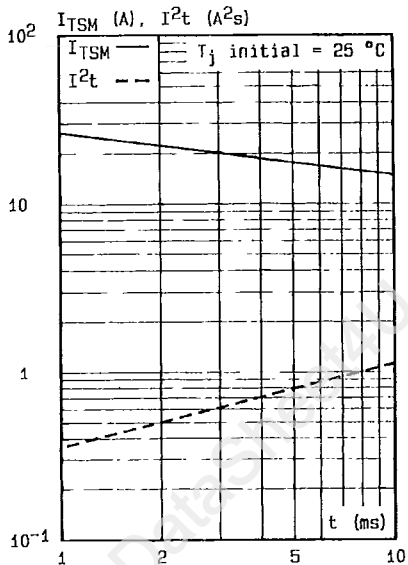

Fig.7 - Non repetitive surge peak on-state current for a sinusoidal pulse with width: $t \leq 10$ ms, and corresponding value of I^2t .

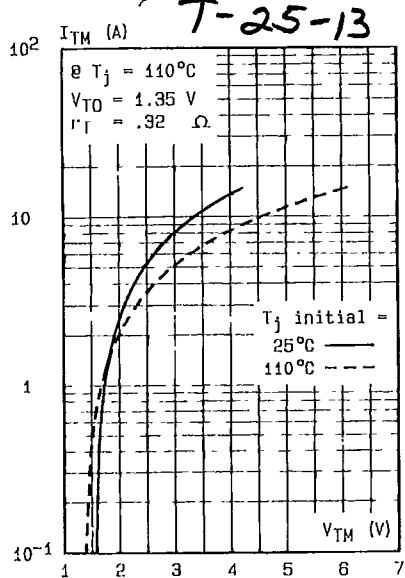

Fig.8 - On-state characteristics (maximum values).