

### SpiceLED™

Like spice, its diminutive size is a stark contrast to its standout performance in terms of brightness, durability and reliability. Despite being the smallest in size yet the SpiceLED™ packs a powerful performance and is a highly reliable design device. Its versatility enables its application in automotive appliances, key-pad illumination, hand-held devices such as PDAs, notebooks, compact back-lighting applications, consumer appliances, office equipment, audio and video equipment.



### Features:

- > High brightness surface mount LED.
- > Super wide viewing angle of 160°.
- > Equivalent to 0805 package outline. Copper lead-frame construction.
- > Qualified according to JEDEC moisture sensitivity Level 2.
- > Compatible to both IR reflow soldering and TTW soldering.
- > Environmental friendly; RoHS compliance.



### Applications:

- > Automotive: interior applications, eg: switches, telematics, climate control system, dashboard, etc.
- > Consumer Appliances: LCD illumination as in PDAs, LCD TV.
- > Communication: indicator and backlight in mobilephone.
- > Display: full color display video notice board.
- > Industry: white goods (eg: Oven, microwave, etc.).



Part Ordering Number	Chip Technology / Color	Viewing Angle°	Luminous Intensity @ IF = 2mA IV (mcd)
<b>SMT-SLD-L2N1-1</b>	<b>InGaN</b>	<b>160</b>	<b>14.00 - 35.50</b>
• SMT-SLD-L2	True Green, 525 nm		14.00 - 18.00
• SMT-SLD-M1			18.00 - 22.40
• SMT-SLD-M2			22.40 - 28.50
• SMT-SLD-N1			28.50 - 35.50
<b>SMB-SLD-H2K1-1</b>	<b>InGaN</b>	<b>160</b>	<b>3.55 - 9.00</b>
• SMB-SLD-H2	Blue, 470 nm		3.55 - 4.50
• SMB-SLD-J1			4.50 - 5.60
• SMB-SLD-J2			5.60 - 7.20
• SMB-SLD-K1			7.20 - 9.00

NOTE

1. All part number above comes in a quantity of 3000 units per reel.
2. Other luminous intensity groups are also available upon request
3. Luminous intensity is measured with an accuracy of  $\pm 11\%$ .
4. Wavelength binning is carried for all units as per the wavelength-binning table. Only one wavelength group is allowed for each reel.

**Wavelength Grouping**

Color	Group	Wavelength distribution (nm)
SMT; True Green	Full	520 - 536
	W	520 - 524
	X	524 - 528
	Y	528 - 532
	Z	532 - 536
SMB; Blue	Full	464 - 476
	W	464 - 468
	X	468 - 472
	Y	472 - 476

Dominant wavelength is measured with an accuracy of  $\pm 1\text{nm}$  .

## Electrical Characteristics at Ta=25°C

www.DataSheet4U.com

Part Number	Vf @ If = 2mA			Vf @ If = 10mA	Vr @ Ir = 10uA
	Min. (V)	Typ. (V)	Max. (V)	Typ. (V)	Min. (V)
SMx-SLD	2.6	2.8	3.0	3.0	5

Forward voltage, Vf is measured with an accuracy of ± 0.1 V.

## Absolute Maximum Ratings

	Maximum Value	Unit
DC forward current	15	mA
Peak pulse current; (tp ≤ 10μs, Duty cycle = 0.1)	100	mA
Reverse voltage; Ir <sub>max</sub> = 10μA	5	V
ESD threshold (HBM)	1000	V
LED junction temperature	110	°C
Operating temperature	-40 ... +100	°C
Storage temperature	-40 ... +100	°C
Power dissipation (at room temperature)	45	mW

## Material

Material	
Lead-frame	Cu Alloy With NiPdAu Plating
Package	High Temperature Resistant Epoxy Resin

Note: product is Pb free

**Intensity Vs Forward Current (True Green)**

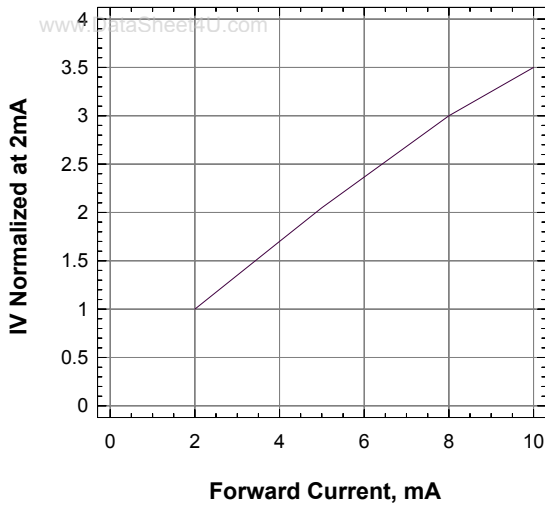

**Intensity Vs Forward Current (Blue)**

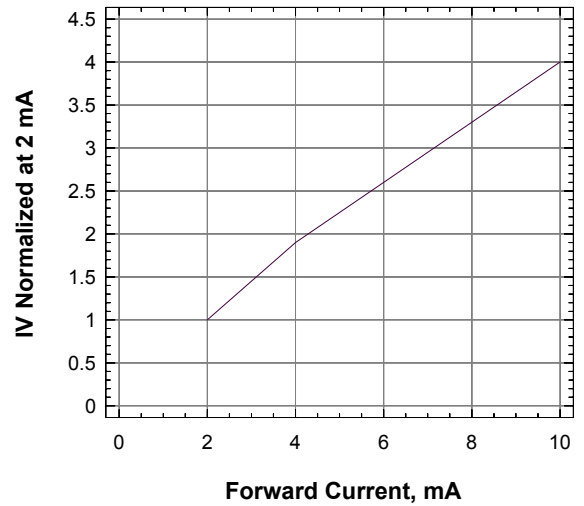

**Forward Current Vs Forward Voltage**

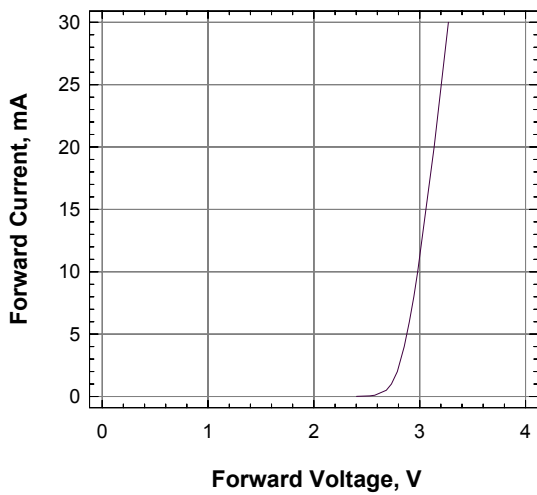

**Maximum Current Vs Ambient Temperature**

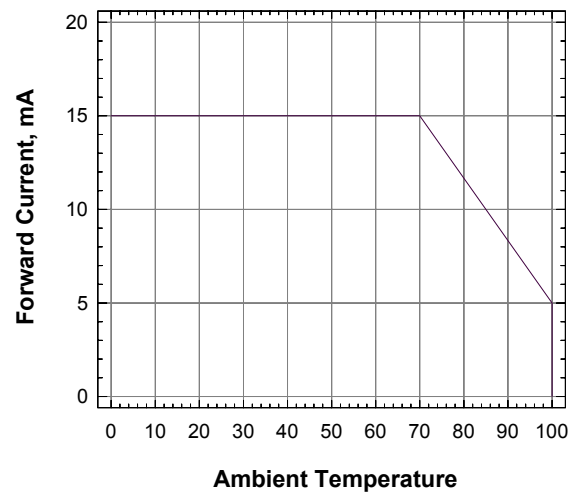

**Relative Intensity Vs Wavelength**

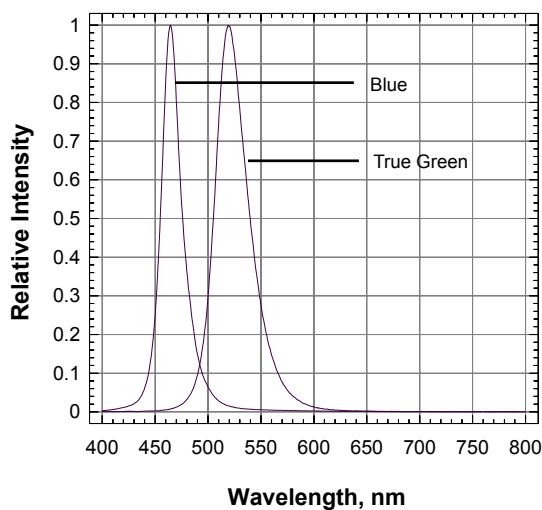

**Dominant Wavelength Vs Forward Current**

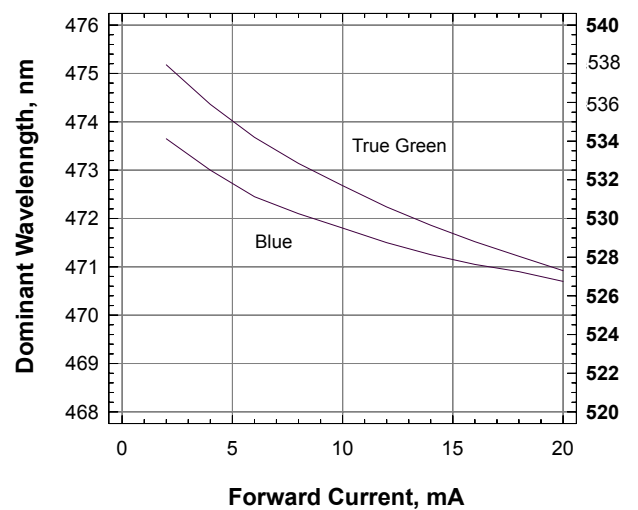

**Radiation Pattern**

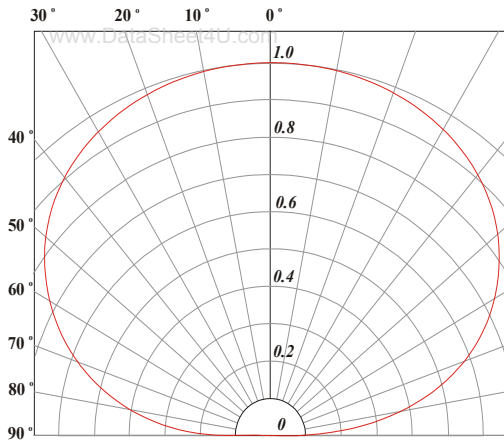

**SpiceLED™ • InGaN M-Spice : SMx-SLD Package Outlines**

www.DataSheet4U.com

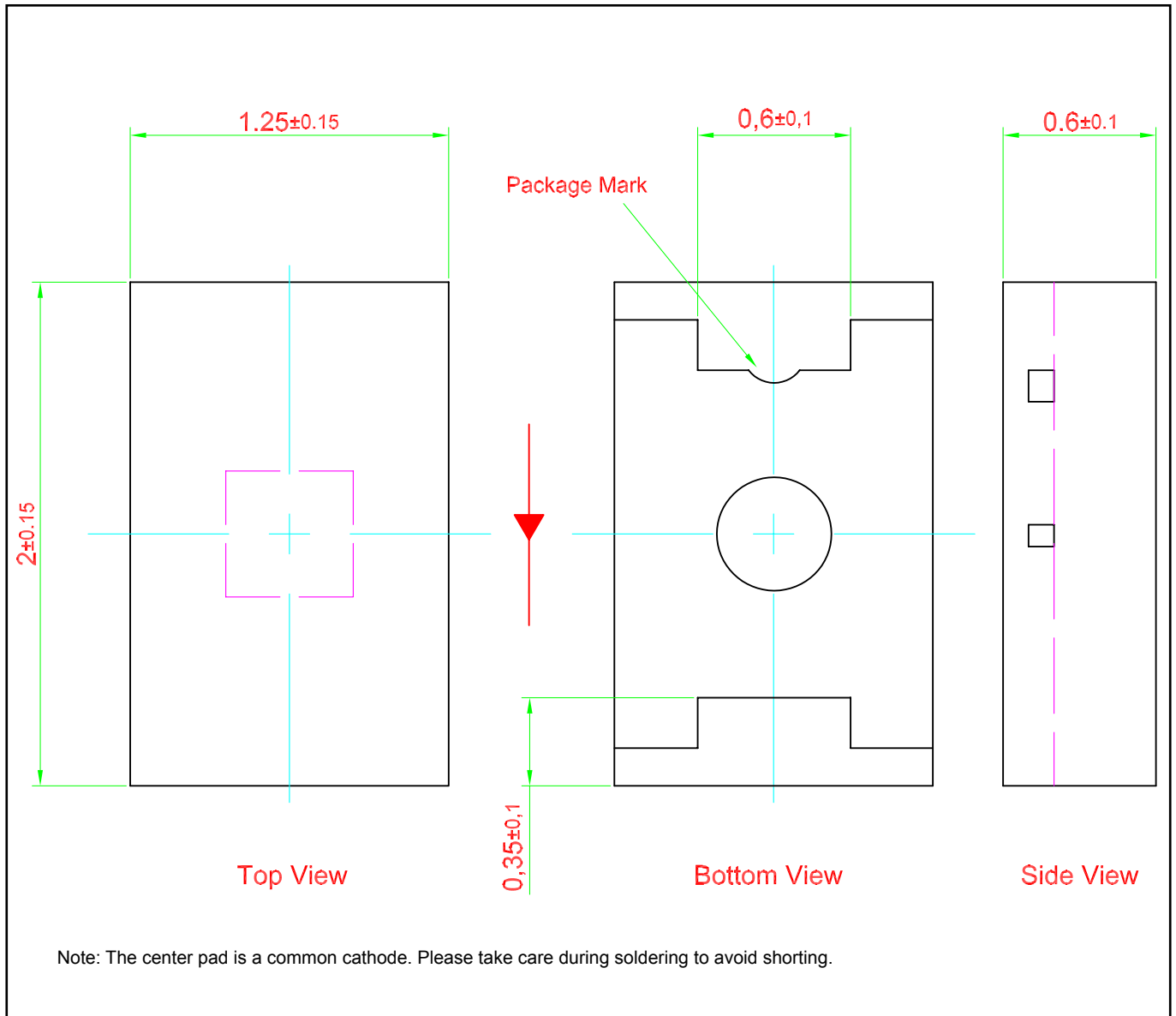

## Recommended Solder Pad

[www.DataSheet4U.com](http://www.DataSheet4U.com)

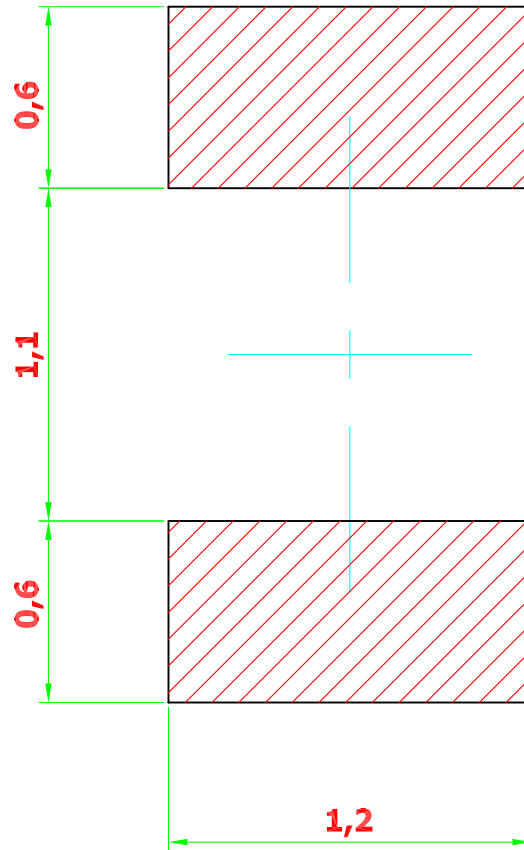

Note: Component is based on a new package platform, which features "Bottom Only Terminations". Solder joints are only formed at the bottom of the component and solder fillet will not be observable as the sides of the component.

**Taping and orientation**

www.DataSheet4U.com

- Reels come in quantity of 3000 units.
- Reel diameter is 180 mm.

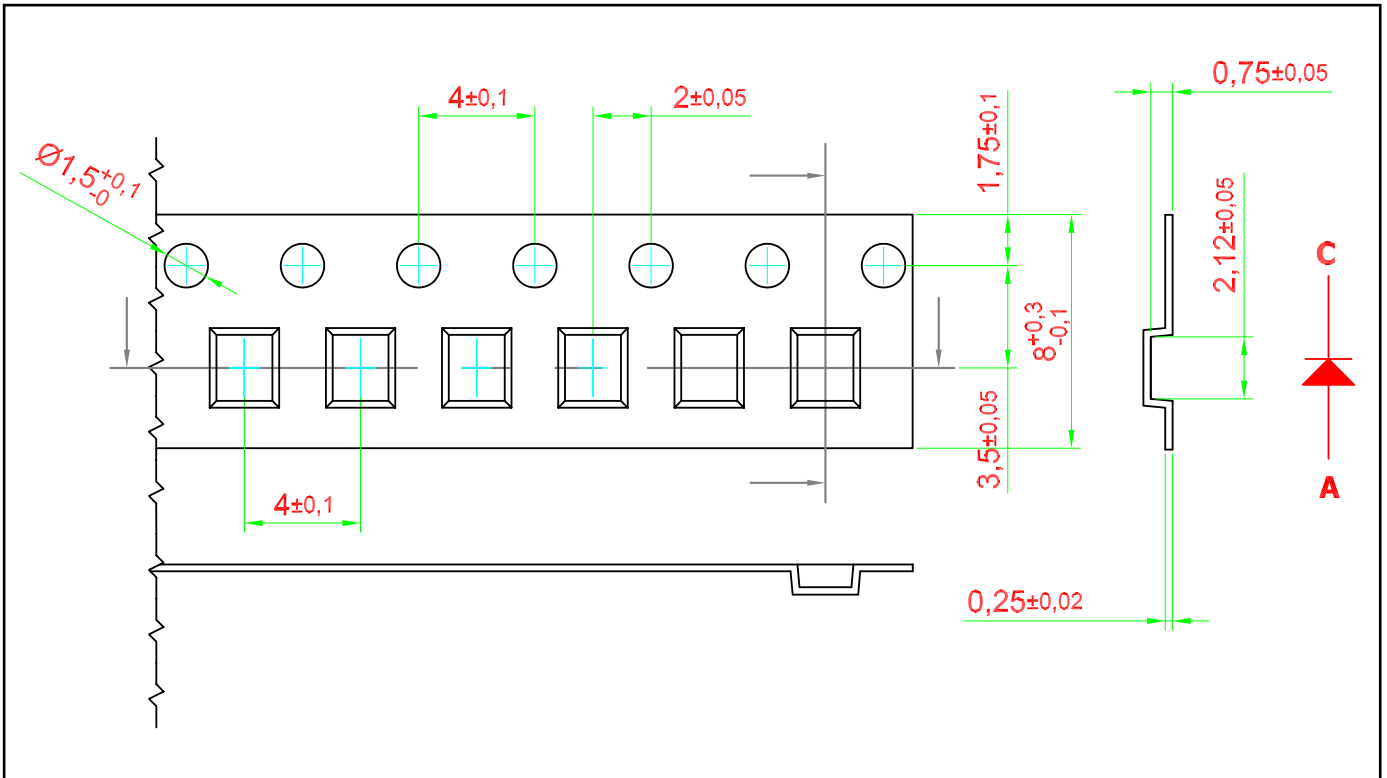



### Packaging Specification

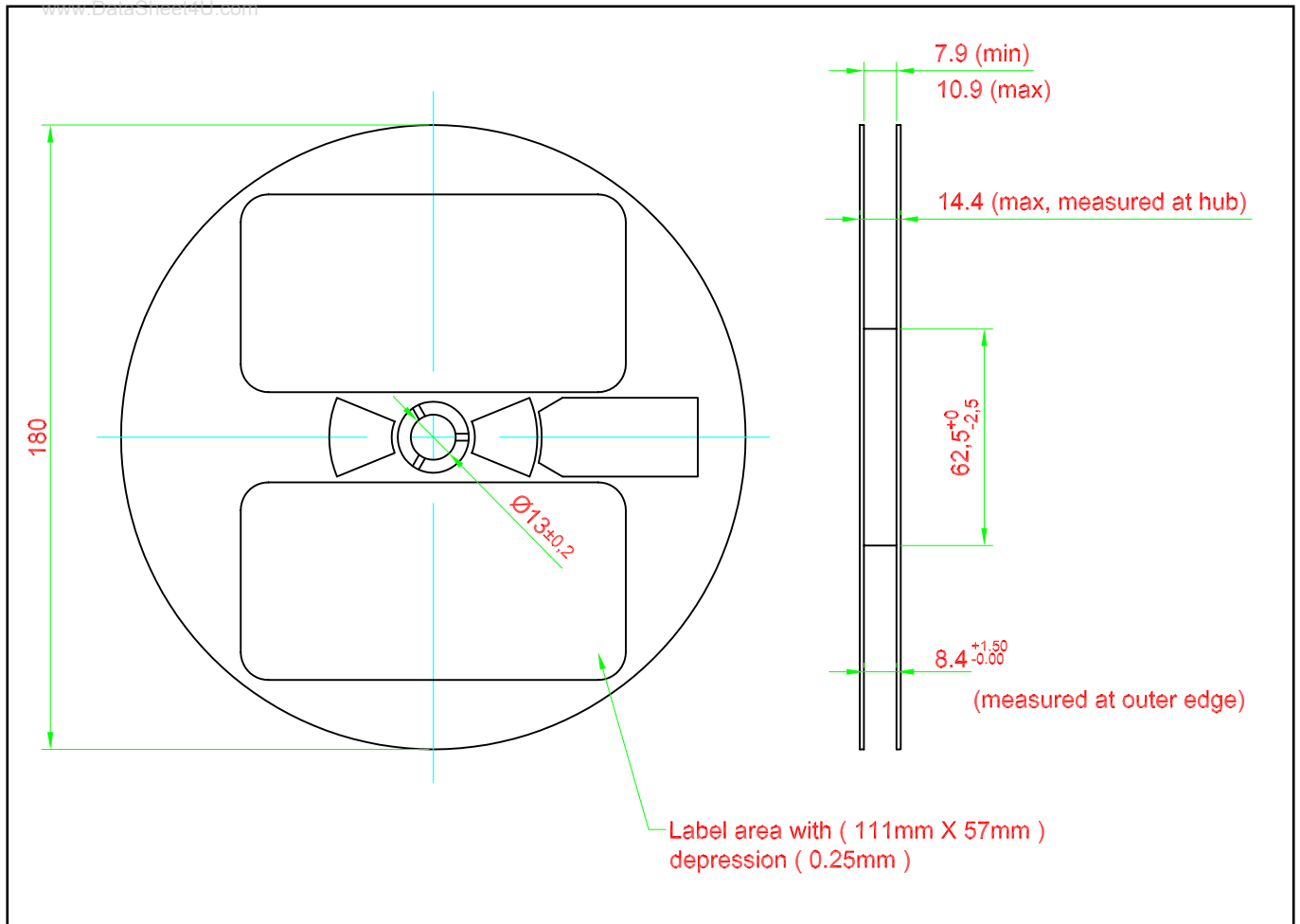

**Packaging Specification**

www.DataSheet4U.com

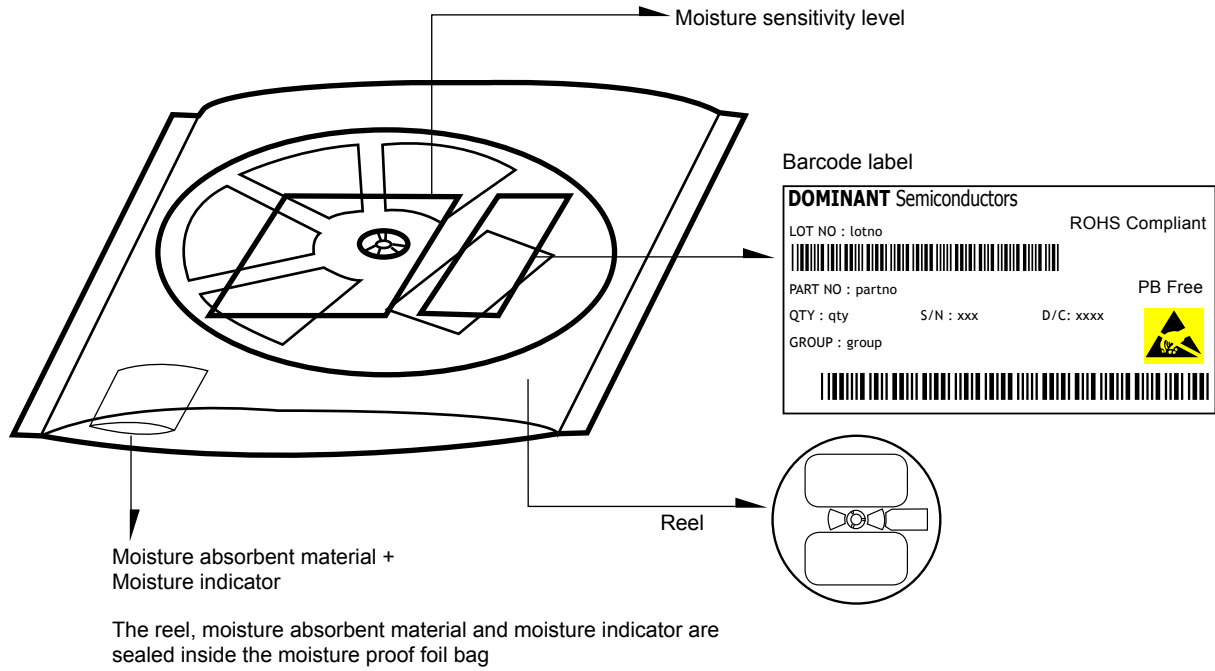

	Average 1pc SpiceLED	1 completed bag (3000pcs)
Weight (gram)	0.001	140 ± 10

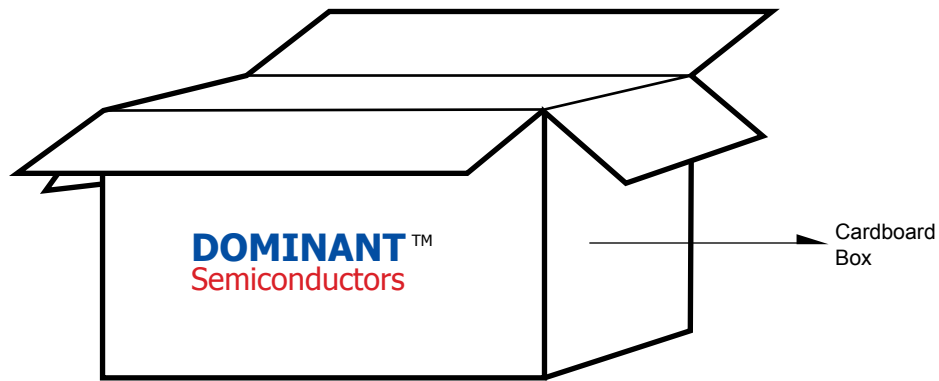

**For SpiceLED™**

Cardboard Box Size	Dimensions (mm)	Empty Box Weight (kg)	Reel / Box	Quantity / Box (pcs)
Small	300 x 250 x 250	0.58	15 reels MAX	45,000 MAX
Large	416 x 516 x 476	1.74	55 reels MAX	165,000 MAX

**Recommended Sn-Pb IR-Reflow Soldering Profile**

www.DataSheet4U.com

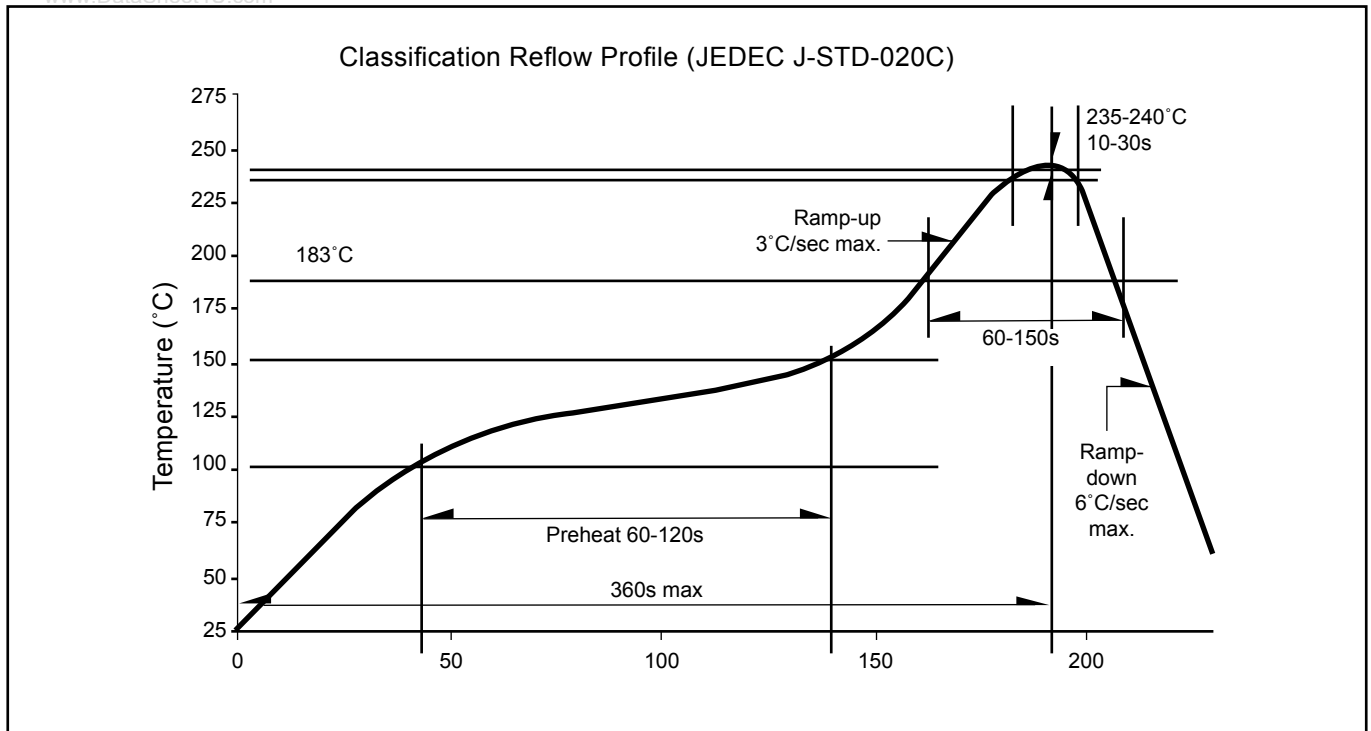

**Recommended Pb-free Soldering Profile**

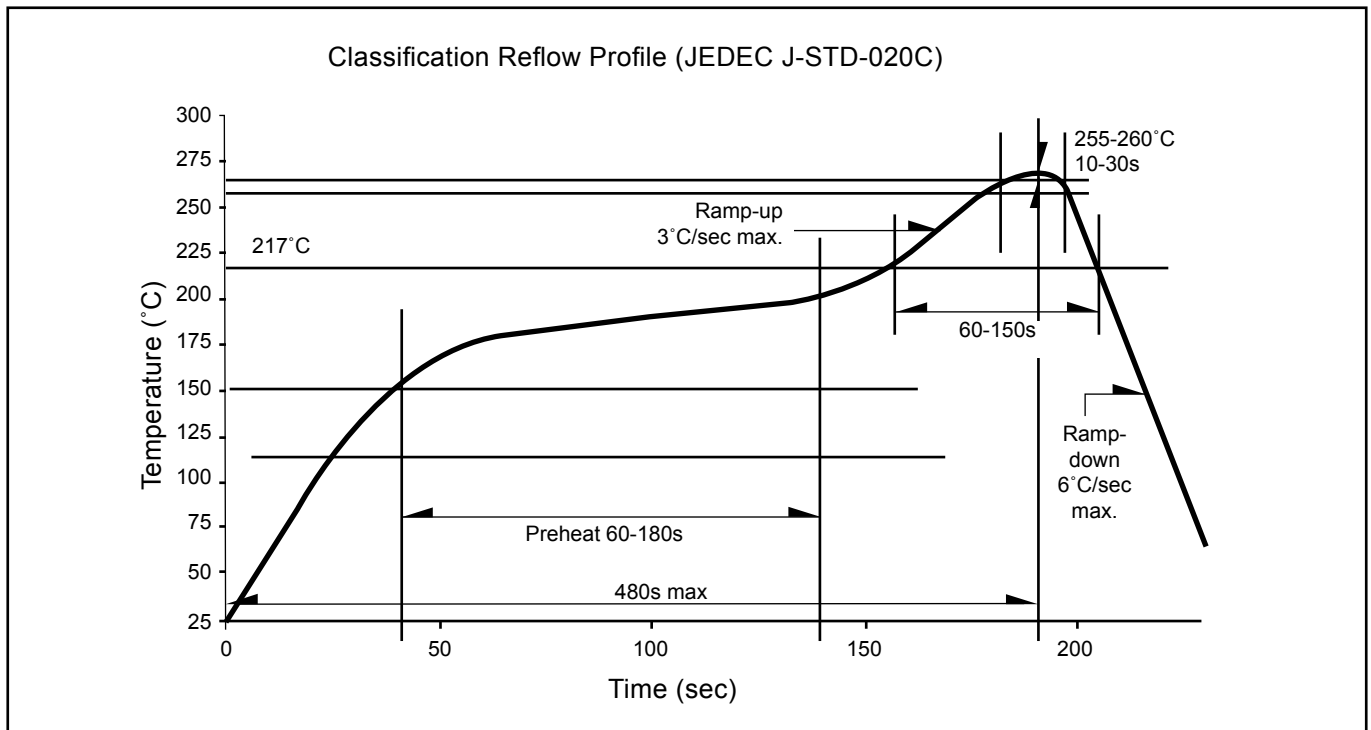

**Revision History**

www.DataSheet4U.com

Page	Subjects	Date of Modification
-	New Format	23 Feb 2006

**NOTE**

All the information contained in this document is considered to be reliable at the time of publishing. However, DOMINANT Semiconductors does not assume any liability arising out of the application or use of any product described herein.

DOMINANT Semiconductors reserves the right to make changes at any time without prior notice to any products in order to improve reliability, function or design.

DOMINANT Semiconductors products are not authorized for use as critical components in life support devices or systems without the express written approval from the Managing Director of DOMINANT Semiconductors.

