

EVALQRS-ICE2QS01-160W

160W SMPS Evaluation Board with Quasi Resonant
Controller ICE2QS01

Power Management & Supply



Never stop thinking.

Edition 2006-12-21

**Published by Infineon Technologies Asia Pacific,
168 Kallang Way,
349253 Singapore, Singapore**

**© Infineon Technologies AP 2004.
All Rights Reserved.**

Attention please!

The information herein is given to describe certain components and shall not be considered as a guarantee of characteristics.

Terms of delivery and rights to technical change reserved.

We hereby disclaim any and all warranties, including but not limited to warranties of non-infringement, regarding circuits, descriptions and charts stated herein.

Information

For further information on technology, delivery terms and conditions and prices please contact your nearest Infineon Technologies Office (www.infineon.com).

Warnings

Due to technical requirements components may contain dangerous substances. For information on the types in question please contact your nearest Infineon Technologies Office.

Infineon Technologies Components may only be used in life-support devices or systems with the express written approval of Infineon Technologies, if a failure of such components can reasonably be expected to cause the failure of that life-support device or system, or to affect the safety or effectiveness of that device or system. Life support devices or systems are intended to be implanted in the human body, or to support and/or maintain and sustain and/or protect human life. If they fail, it is reasonable to assume that the health of the user or other persons may be endangered.

Table of Contents

Topics	Page
1 Introduction	6
2 Evaluation Board	6
3 Technical Specification	7
4 Circuit Description	7
4.1 Mains Input and Rectification	
4.2 PWM Control	
4.3 Snubber Network	
4.4 Minimum Power at Normal Mode	
4.5 Output Stage	
4.6 Feedback Loop	
5 Circuit Operation	8
5.1 Start up	
5.2 Normal Mode Operation	
5.3 Standby Mode Operation	
6 Protection Features	8
6.1 IC Supply Overvoltage	
6.2 IC Supply Undervoltage	
6.3 Mains Undervoltage Protection	
6.4 Primary Current Simulation and Pulse by Pulse current Limit	
6.5 Fold Back Correction	
7 Circuit Diagram	9
8 PCB Layout	10
8.1 Top Layer	
8.2 Bottom Layer	
9 Component List	11
10 Transformer Construction	12
11 Test Report	13
11.1 Efficiency versus line voltage	
11.2 Standby Power in Burst Mode Operation	
11.3 Efficiency versus load at 220VAC line voltage	
11.4 Switching frequency versus load at line voltage 85VAC	

160W SMPS Evaluation Board with Quasi Resonant Controller ICE2QS01

12 Test Waveforms	15
12.1 Startup behaviour	
12.2 Switching at different zero crossings	
12.3 Burst Mode operation	
13 References	19

160W SMPS Evaluation Board with Quasi Resonant Controller ICE2QS01

1. Introduction

The board described here was designed as a typical power supply in quasi-resonant flyback converter topology with multi output voltage and secondary control. This type of AC/DC power supply is particularly suitable for TV application. The PWM controller **ICE2QS01** used for this application is a newly developed IC from the Infineon Technologies's quasi-resonant controller family with enhancements to satisfy the needs for low standby power and protection features. In normal operation, digital frequency reduction technique is used to avoid high frequency caused interference, lower the power consumption, avoid any jitter toward stabilization system and support stable output in this mode. In standby mode, the converter is operated in **Active Burst Mode** to lower the power consumption and support a stable output voltage with smaller ripple. In this mode, the converter is still in active mode and responses fast to load changes. In case of failure mode like open loop, overvoltage or overload due to short circuit, the device switches in **Auto Restart Mode** or **Latch-off Mode** which is controlled by the internal protection unit. By means of the cycle-by-cycle peak current limitation plus foldback correction, the dimension of the transformer and the secondary diode can be lower which leads to more cost effective design.

2. Evaluation Board

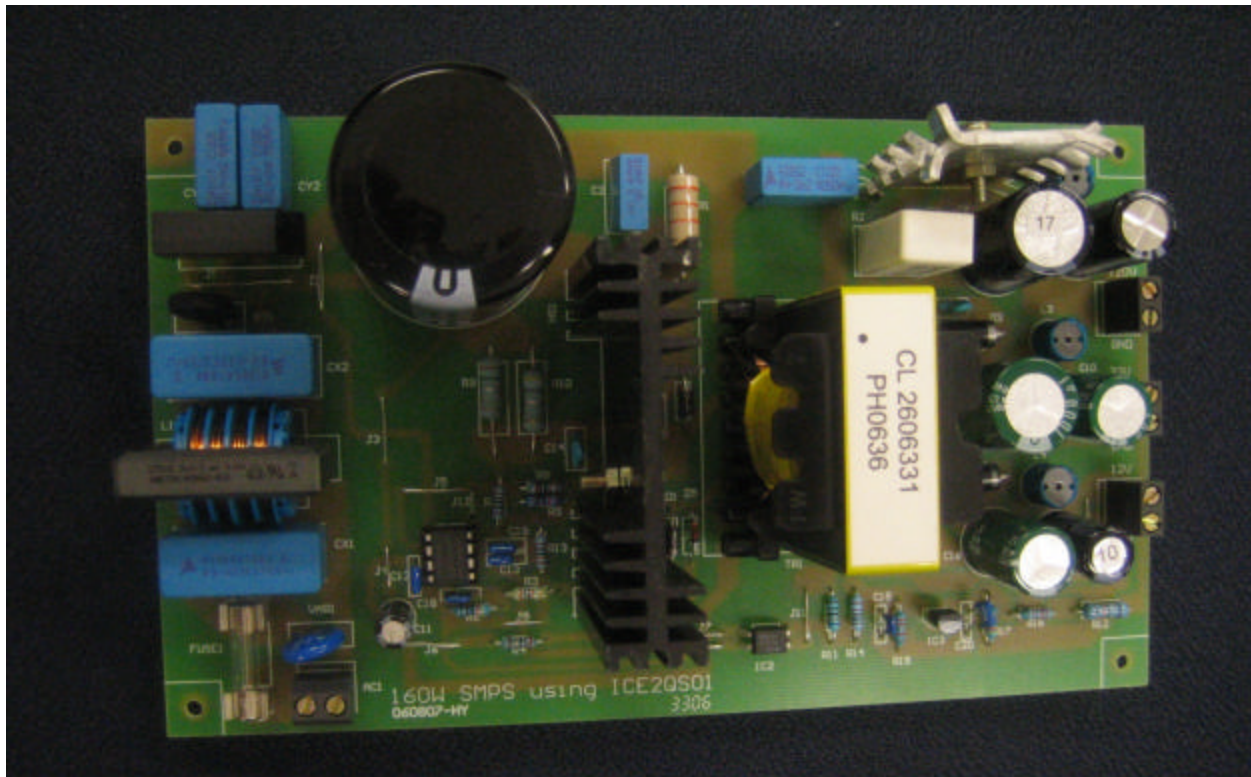

160W SMPS Evaluation Board with Quasi Resonant Controller ICE2QS01

3. Technical Specification

Input voltage	85VAC~265VAC	
Input frequency	50Hz	
Output voltage and current	120V	0.83A
	33V	1.5A
	12V	0.85A
Output power	160W	
Efficiency	>80% at full load	
Minimum switching frequency at full load, lowest line voltage	40kHz	
Standby power	<1W at no load	

4. Circuit Description

4.1 Mains Input and Rectification

The AC line input side comprises the input fuse FUSE1 as overcurrent protection. The X2 Capacitor CX1, CX2 and Choke L1 and Y1 capacitor CY2 and CY3 form a main filter to minimize the feedback of RFI into the main supply. The bridge rectifier BR1, together with a smoothing capacitor C1, provide a voltage of 80 to 380 VDC depending on the input voltage available. The varistor VAR1 after fuse can absorb the input surge transient voltage and the thermistor RT1 in series with the input can limit the input inrush current during the first plug in of the AC input line.

4.2 PWM Control

The PWM pulse is generated by 8pin Quasi Resonant Controller ICE2QS01. ICE2QS01 is a current mode controller. The ICE2QS01 comprises the complete control for free running flyback switch mode power supply for TV application.. It also performs all necessary protection functions in flyback converters. The IC functions will be described in the next section.

4.3 Snubber Network

A snubber network R1, C2 and D2 dissipate the energy of the leakage Inductance and to suppress ringing in the SMPS transformer.

4.4 Output Stage

There are three secondary output, the 120V (scan voltage for deflection stage), 33V (audio supply), and 12V (small signal supply), The 5V standby supply for microcontroller can be derived from a regulator connected to the 12V output. On the secondary side, the power is coupled out via a group of ultra-fast diodes D4, D3 and D6. The capacitors C8, C7 and C16 provide energy buffering following with the L-C

160W SMPS Evaluation Board with Quasi Resonant Controller ICE2QS01

filters to reduce the output ripple and prevent interference between SMPS switching frequency and line frequency considerably. Storage capacitors C8, C7 and C16 are designed to have an internal resistance as small as possible (ESR). This is to minimize the output voltage ripple caused by the triangular current characteristic.

4.5 Feedback Loop

For feedback, the output is sensed by the voltage divider of R12, R16 and R17 and compared to TL431 internal reference voltage. The output voltage of TL431 is converted to the current signal via optocoupler for regulation control.

5. Circuit Operation

5.1 Startup

Since there is a built-in startup cell in the ICE2QS01, there is no need for external start up resistor. The power cell is connected to the HV pin of the IC. Once the voltage is built up at the HV pin, the power cell will charge up the V_{CC} capacitor C11. When the V_{CC} voltage exceeds the IC on-threshold, the IC begins to operate with a soft-start and the power cell is switched off. Then the V_{CC} voltage is sustained by the auxiliary winding.

The soft-start implemented in the ICE2QS01 is a digital time-based function. The pulse width is increased by step every 3 ms. The preset maximum time is 24ms.

5.2 Normal Mode Operation with Digital Frequency Reduction

An important characteristic of the ICE2QS01 is its load dependent frequency response for free running switched mode power supplies (SMPS). This internal function reduces the frequency gradually as the load drops, thus allows a high degree of efficiency with light loads.

5.3 Active Burst Mode Operation

At very low load condition, the IC enters active burst mode operation to minimize input power and thus to increase efficiency.

6. Protection Features

6.1 IC Supply Overvoltage and Undervoltage

If V_{CC} exceeds the V_{CC} over-voltage threshold 25V (overvoltage threshold), IC will stop switching and wait for the V_{CC} to fall below under-voltage 10.5V (typical). After that, IC will re-start and begin to re-charge the V_{CC}. If V_{CC} drops to lower than 10.5V (under voltage threshold), IC will stop switching and begin to charge the V_{CC}.

6.2 Fold Back Correction

160W SMPS Evaluation Board with Quasi Resonant Controller ICE2QS01

This function is necessary in free running SMPS to make the maximum output power independent on AC input voltage. By mean of this the dimension of the transformer can be smaller and the rating of secondary diode can be lower, which leads to more cost efficiency. This feature is obtained by reducing the current limit and thus lower power at high main input voltage.

6.3 Openloop/overload protection

In case of open control loop after the blanking time, the regulation voltage **Vreg** is pulled up with internally block. After a blanking time of 24ms, the IC enters **auto-restart mode**. In case of secondary short-circuit or overload, regulation voltage **Vreg** will also be pulled up, same protection will be applied and IC will enters **auto-start mode**.

6.4 Adjustable output overvoltage protection

During off-time of the power switch, the voltage at the zero-crossing pin is monitored for output overvoltage detection. If the voltage is higher than the preset threshold for a preset period, the IC is latched off.

6.5 Short-winding protection

If the voltage at the current sensing pin is higher than the preset threshold during on-time of the power switch, the IC is latched off. This is short-winding protection.

7 Circuit Diagram

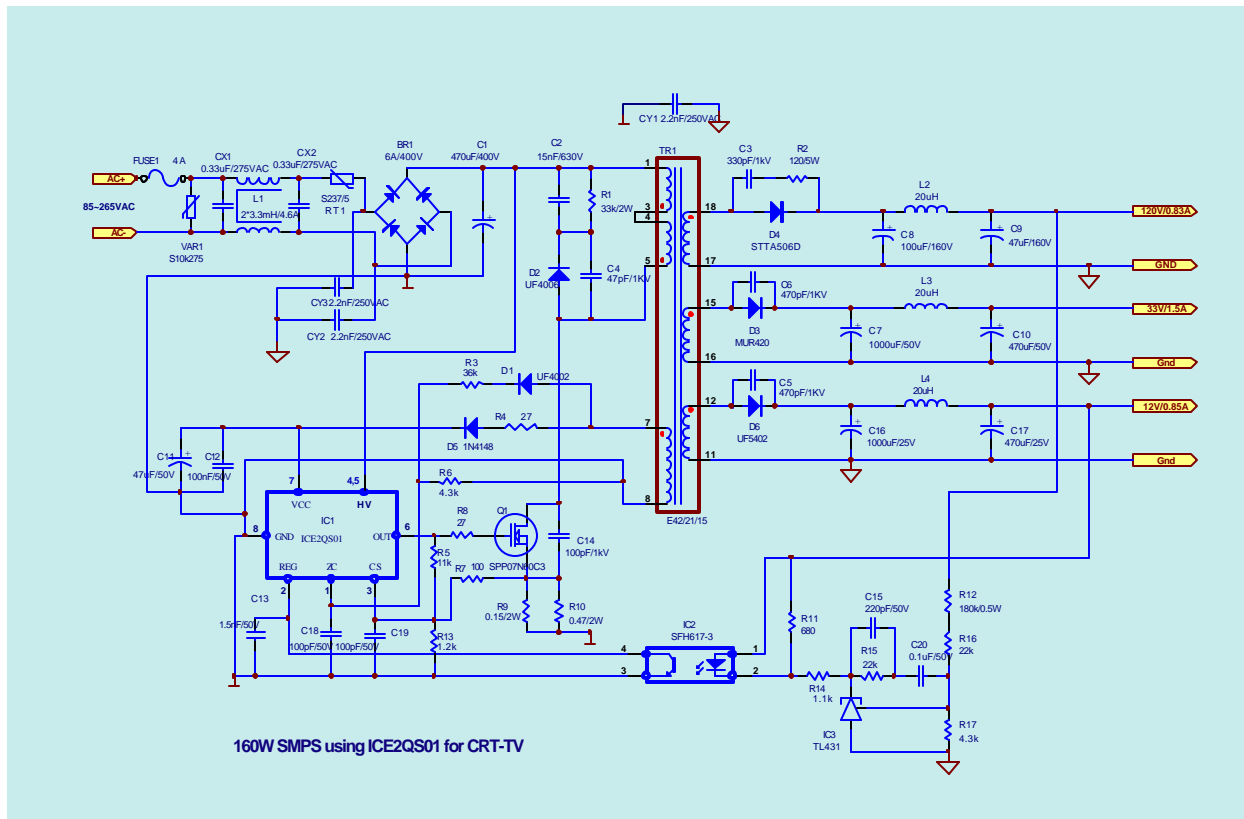

160W SMPS Evaluation Board with Quasi Resonant Controller ICE2QS01

8 PCB Layout 8.1 Top Layer

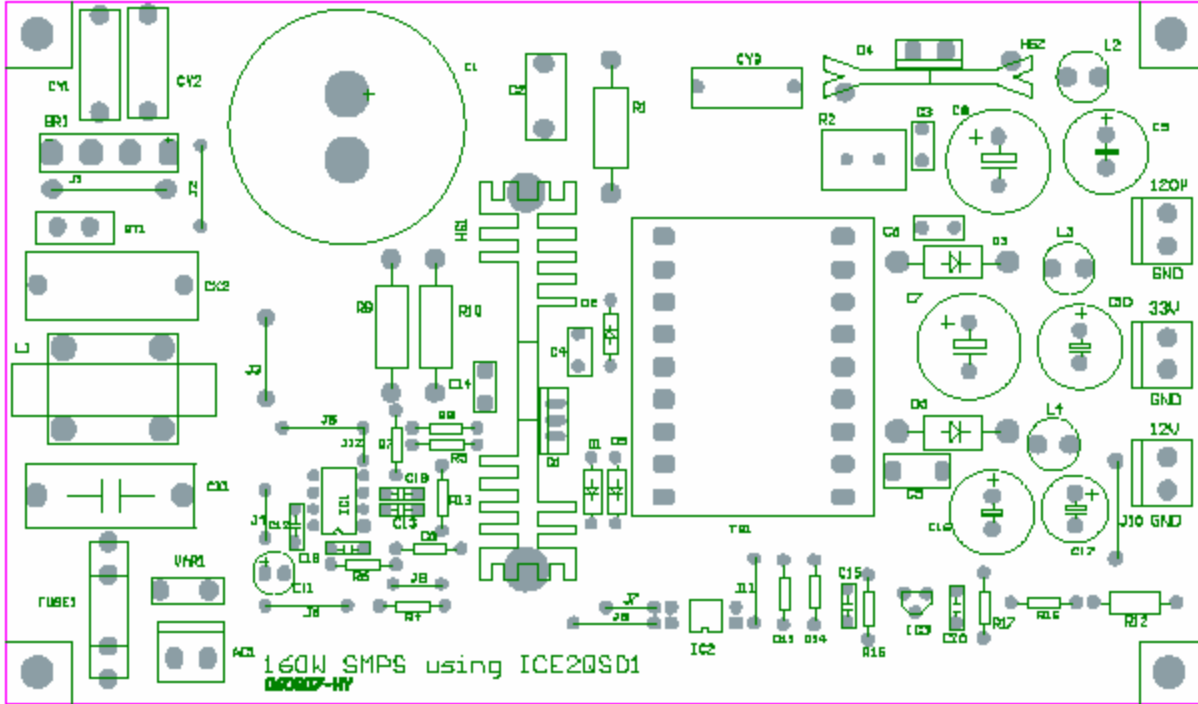

8.2 Bottom Layer

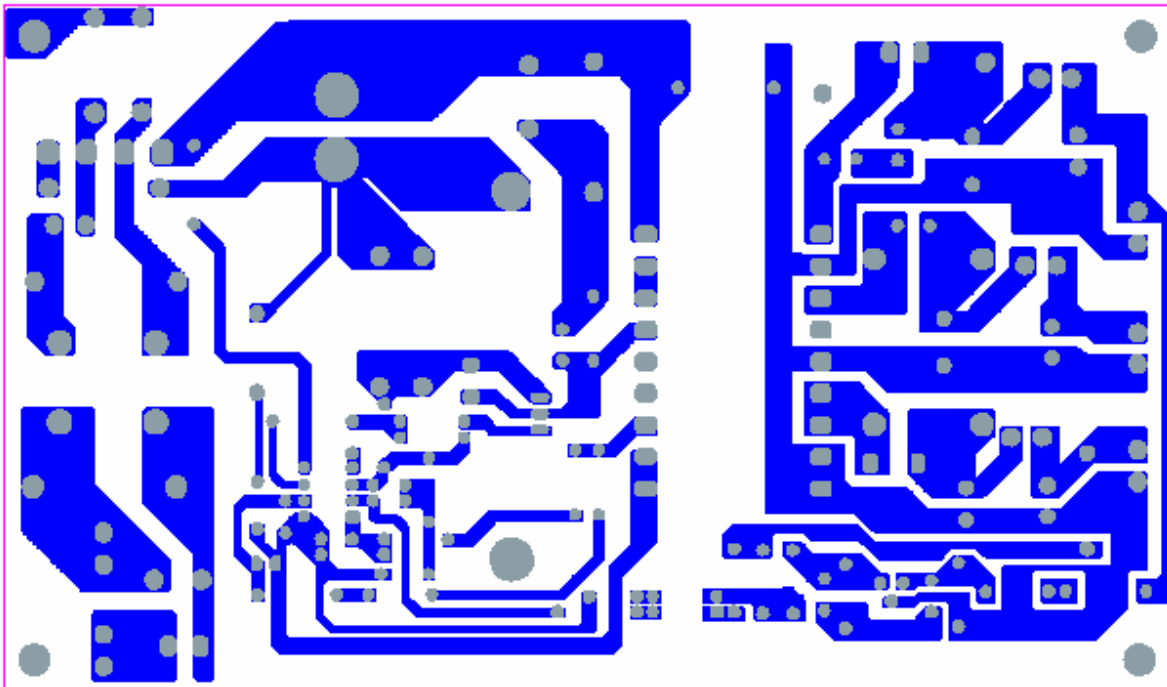

9 Component List

Item	Part	Part Type	Number
1	BR1	6A/400V	1
2	C1	470uF/400V	1
3	C2	15nF/630V	1
4	C3	330pF/1kV	1
5	C4	47pF/1KV	1
6	C5	470pF/1KV	1
7	C6	470pF/1KV	1
8	C7	1000uF/50V	1
9	C8	100uF/160V	1
10	C9	47uF/160V	1
11	C10	470uF/50V	1
12	C11	47uF/50V	1
13	C12	100nF/50V	1
14	C13	1.5nF/50V	1
15	C14	100pF/1kV	1
16	C15	220pF/50V	1
17	C16	1000uF/25V	1
18	C17	470uF/25V	1
19	C18	100pF/50V	1
20	C19	100pF/50V	1
21	C20	0.1uF/50V	1
22	CX1	0.33uF/275VAC	1
23	CX2	0.33uF/275VAC	1
24	CY1	2.2nF/250VAC	1
25	CY2	2.2nF/250VAC	1
26	CY3	2.2nF/250VAC	1
27	D1	UF4002	1
28	D2	UF4006	1
29	D3	MUR420	1
30	D4	STTA506D	1
31	D5	1N4148	1
32	D6	UF5402	1
33	FUSE1	0.166666667	1
34	IC2	SFH617-3	1
35	IC3	TL431	1
36	L1	2*3.3mH/4.6A	1
37	L2	20uH	1
38	L3	20uH	1
39	L4	20uH	1
40	Q1	SPP07N60C3	1
41	R1	33k/2W	1
42	R2	120/5W	1
43	R3	36k	1

160W SMPS Evaluation Board with Quasi Resonant Controller ICE2QS01

44	R4	27	1
45	R5	11k	1
46	R6	4.3k	1
47	R7	100	1
48	R8	27	1
49	R9	0.15/2W	1
50	R10	0.47/2W	1
51	R11	680	1
52	R12	180k/0.5W	1
53	R13	1.2k	1
54	R14	1.1k	1
55	R15	22k	1
56	R16	22k	1
57	R17	4.3k	1
58	RT1	S237/5	1
59	TR1	E42/21/15	1
60	VAR1	S10k275	1

10 Transformer Construction

Core size: EE42/21/15 (EPCOS) Core material N87 (Epcos) or BH1(NEC/TOKIN) or PC40 (TDK)
 Bobbin: EE42/21/15 (18pins) Vertical Version
 Primary Inductance, $L_p=155\mu\text{H}$, measured between pin 1 and pin 4 (Gapped to Inductance)

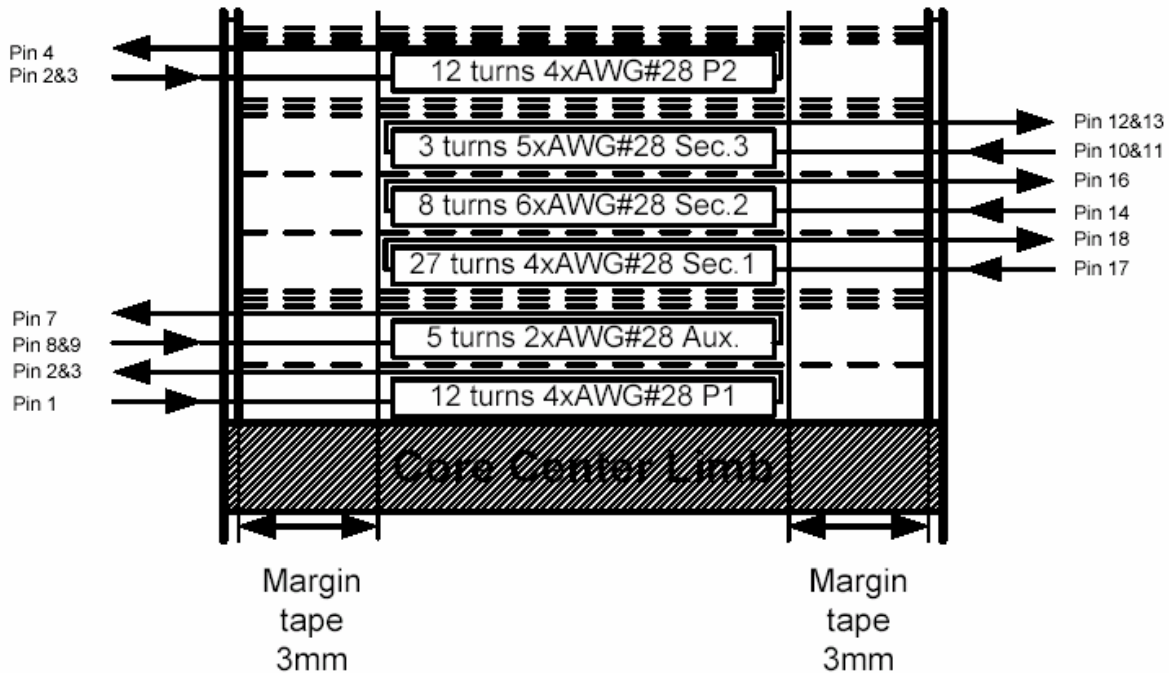

160W SMPS Evaluation Board with Quasi Resonant Controller ICE2QS01

11 Test Report

11.1 Efficiency versus line voltage

V _{in} (V)	I _{in} (A)	P _{in} (W)	P _{out} (W)	h (%)	120V (0.83A)		33V (1.5A)		12V (0.85A)	
					V _{o1}	I _{o1}	V _{o2}	I _{o2}	V _{o3}	I _{o3}
85	1.21	56.9	50.034	87.9332	119.21	0.3	35.1	0.3	12.47	0.3
	2.21	114.7	100.014	87.1962	119.23	0.6	35.01	0.6	12.45	0.6
	3.57	190.3	161.901	85.0767	119.2	0.83	34.95	1.5	12.4	0.85
110	0.98	56.53	50.022	88.4875	119.23	0.3	35.04	0.3	12.47	0.3
	1.8	113.2	99.996	88.3357	119.2	0.6	35.02	0.6	12.44	0.6
	2.85	183.6	161.766	88.1081	119.18	0.83	34.86	1.5	12.42	0.85
140	0.81	56.5	50.022	88.5345	119.21	0.3	35.03	0.3	12.5	0.3
	1.52	112.4	100.014	88.9804	119.2	0.6	35.02	0.6	12.47	0.6
	2.37	180.7	161.755	89.5157	119.21	0.83	34.83	1.5	12.43	0.85
180	0.67	56.8	50.031	88.0827	119.21	0.3	35.09	0.3	12.47	0.3
	1.26	112.4	100.002	88.9698	119.21	0.6	35.03	0.6	12.43	0.6
	1.98	179.9	162.006	90.0531	119.2	0.83	34.98	1.5	12.47	0.85
220	0.59	57.4	50.028	87.1568	119.21	0.3	35.07	0.3	12.48	0.3
	1.09	113.4	99.996	88.1799	119.21	0.6	35.01	0.6	12.44	0.6
	1.69	179.7	161.625	89.9415	119.18	0.83	34.76	1.5	12.43	0.85
265	0.52	58.6	50.028	85.372	119.21	0.3	35.06	0.3	12.49	0.3
	0.96	113.2	100.008	88.3463	119.21	0.6	35	0.6	12.47	0.6
	1.47	181.4	161.645	89.1097	119.15	0.83	34.79	1.5	12.43	0.85

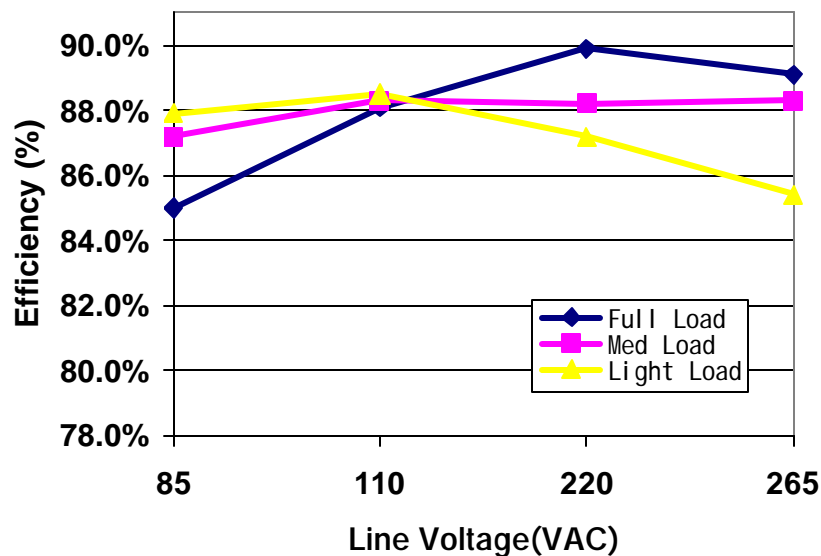

160W SMPS Evaluation Board with Quasi Resonant Controller ICE2QS01

11.2 Standby Power (Burst Mode Operation)

V _{in} (V)	P _{in} (mW)	120V		33V		12V	
		V _{o1}	I _{o1}	V _{o2}	I _{o2}	V _{o3min}	I _{o3}
85	702	119.32	0.0	35.20	0.0	9.05	0.045
110	706	119.31	0.0	35.3	0.0	9.03	0.045
220	798	119.32	0.0	34.8	0.0	8.63	0.045
265	917	119.31	0.0	34.6	0.0	8.53	0.045

11.3 Efficiency vs. Load at 220VAC input voltage

P _{in} (W)	V _{o1} (V)	I _{o1} (A)	V _{o2} (V)	I _{o2} (A)	V _{o3} (V)	I _{o3} (A)	P _o (W)	Efficiency (%)
22.4	119.23	0.1	34.97	0.1	12.56	0.1	16.676	74.45%
31.3	119.23	0.15	34.98	0.15	12.54	0.15	25.0125	79.91%
40.7	119.21	0.2	35.05	0.2	12.51	0.2	33.354	81.95%
58.5	119.21	0.3	35.03	0.3	12.48	0.3	50.016	85.50%
76.3	119.2	0.4	35	0.4	12.43	0.4	66.652	87.36%
113.4	119.18	0.6	34.99	0.6	12.43	0.6	99.96	88.15%
144	119.17	0.7	34.87	1	12.43	0.7	126.99	88.19%
182.7	119.17	0.83	34.79	1.5	12.44	0.85	161.6701	88.49%

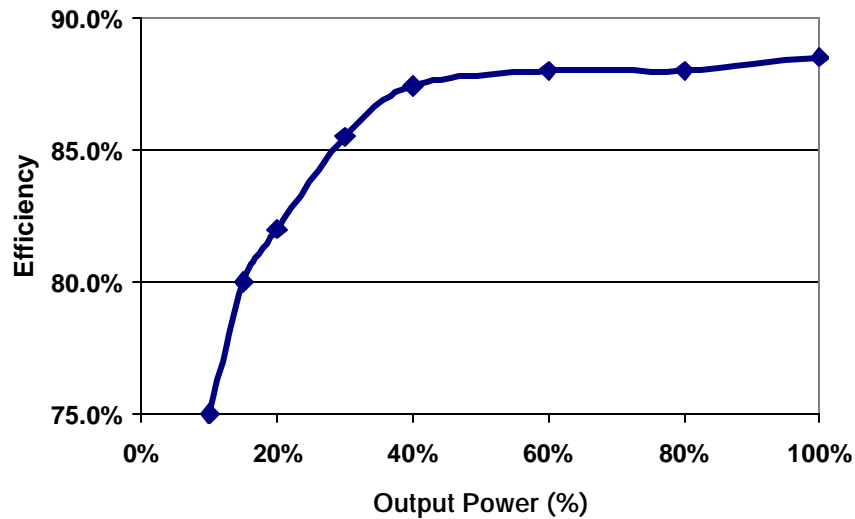

Efficiency versus output power at line voltage 220VAC

160W SMPS Evaluation Board with Quasi Resonant Controller ICE2QS01

11.4 Switching frequency versus load at line voltage 85VAC

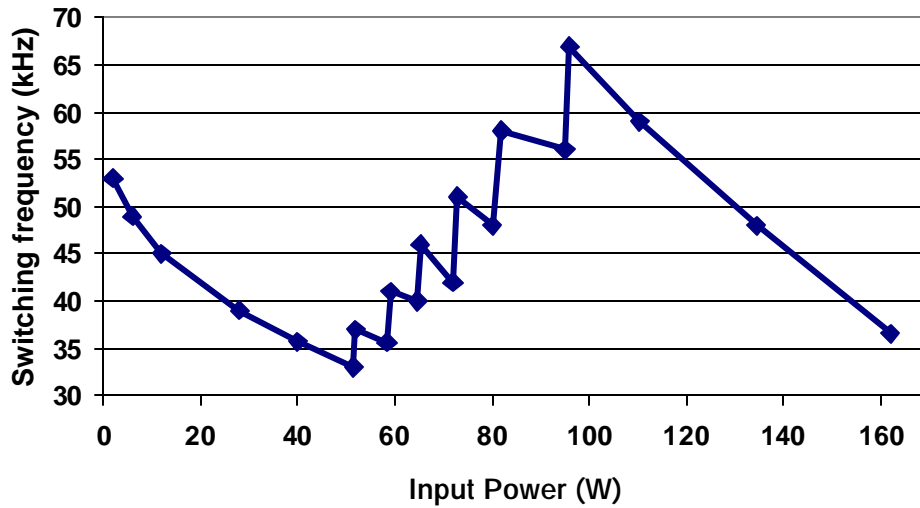

Switching frequency versus load at line voltage 85VAC

12 Test Waveforms

12.1 Startup Behavior of the system with 50W (120V/0.3A, 33V/0.3A and 12V/0.3A) output load condition

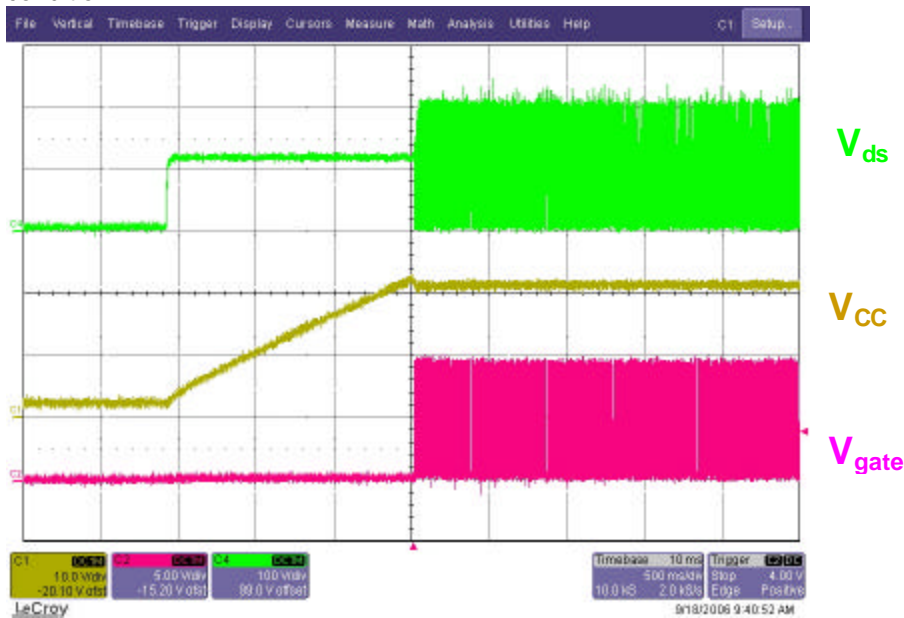

160W SMPS Evaluation Board with Quasi Resonant Controller ICE2QS01

12.2 Switching at different zero crossings

Switch at the first zero crossing

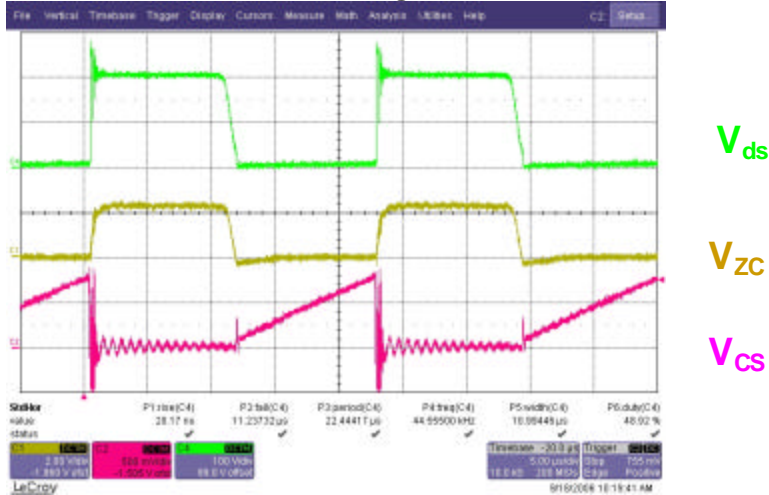

V_{ds}

V_{zc}

V_{cs}

Switch at the second zero crossing

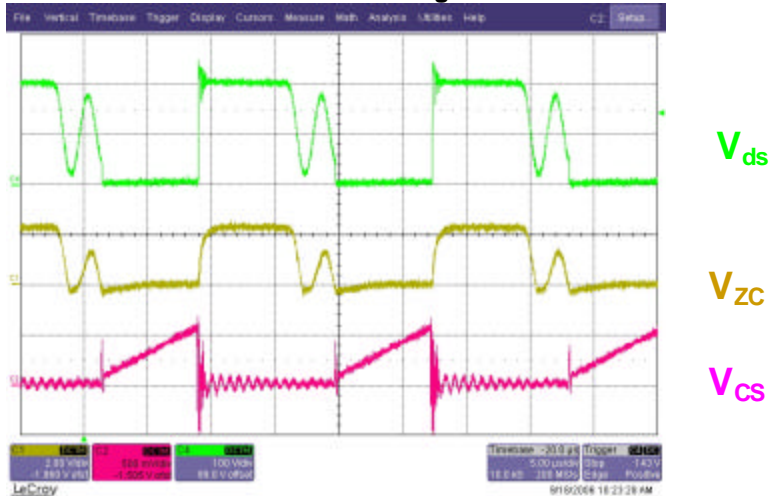

V_{ds}

V_{zc}

V_{cs}

Switch at the third zero crossing

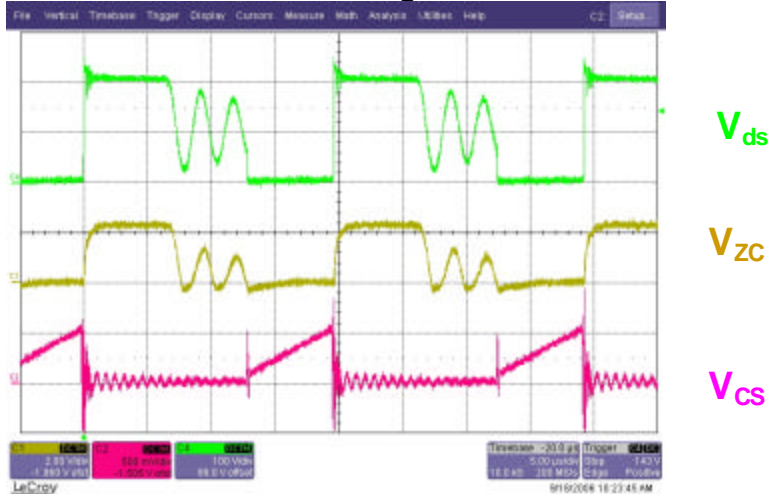

V_{ds}

V_{zc}

V_{cs}

160W SMPS Evaluation Board with Quasi Resonant Controller ICE2QS01

Switch at the fourth zero crossing

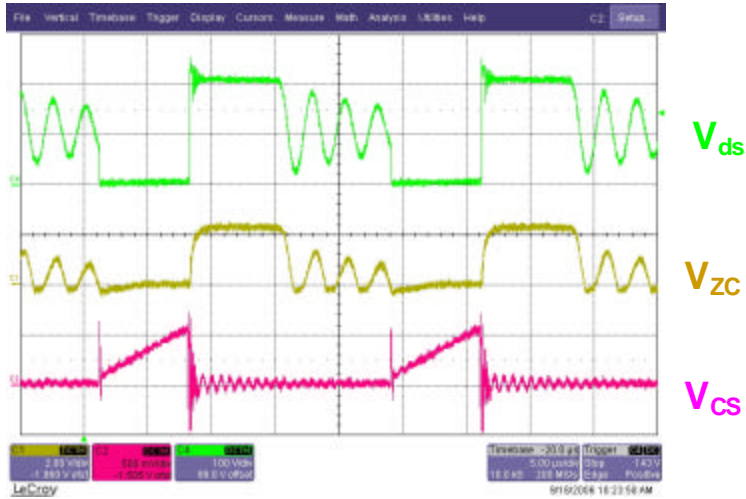

Switch at the fifth zero crossing

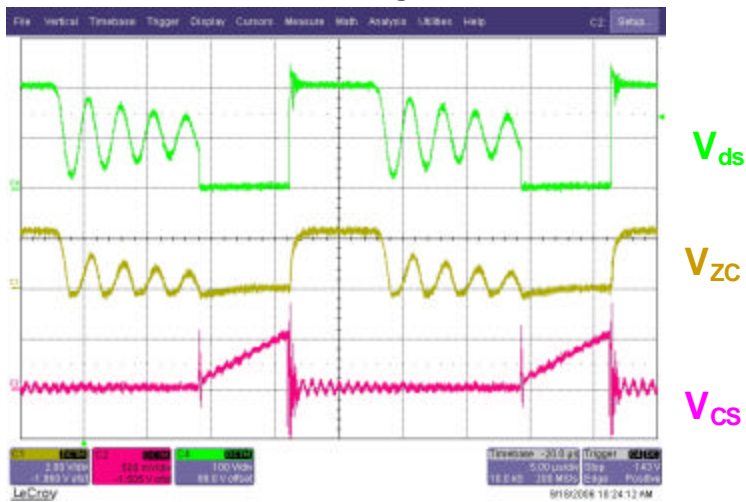

Switch at the sixth zero crossing

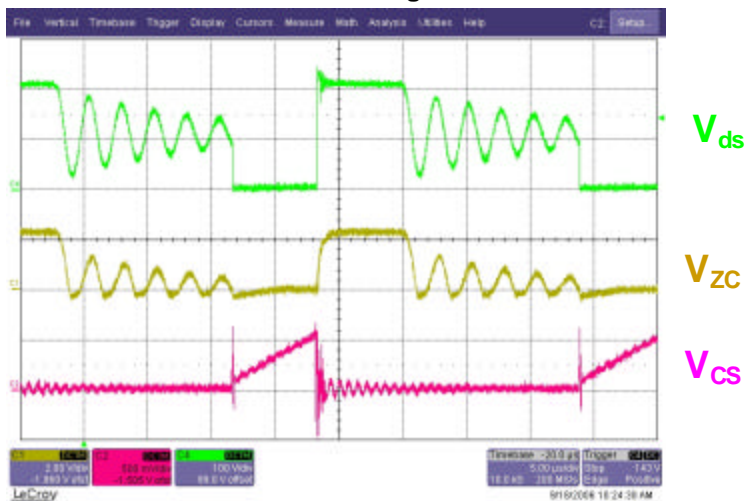

160W SMPS Evaluation Board with Quasi Resonant Controller ICE2QS01

Switch at the seventh zero crossing

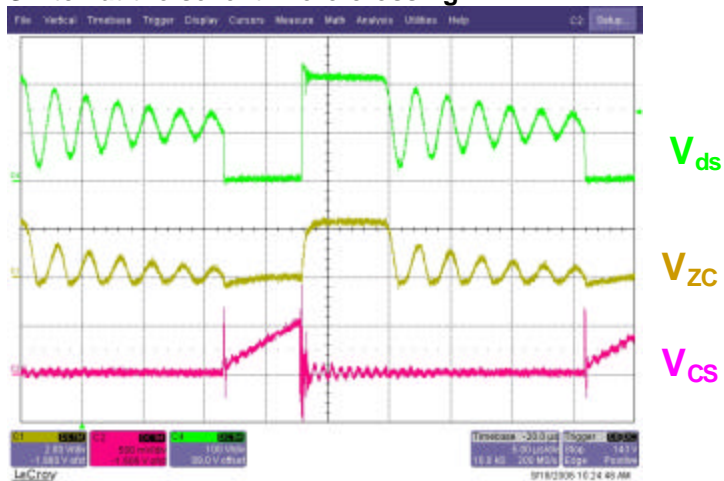

12.3 Burst Mode Operation

Entering active burst mode

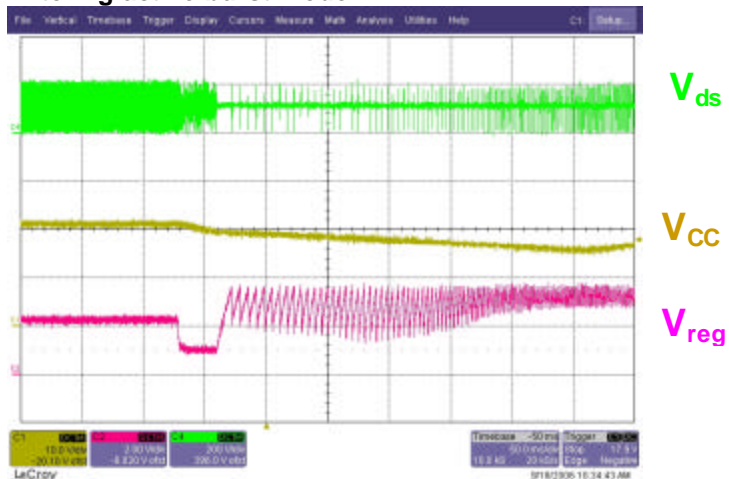

Operation in active burst mode

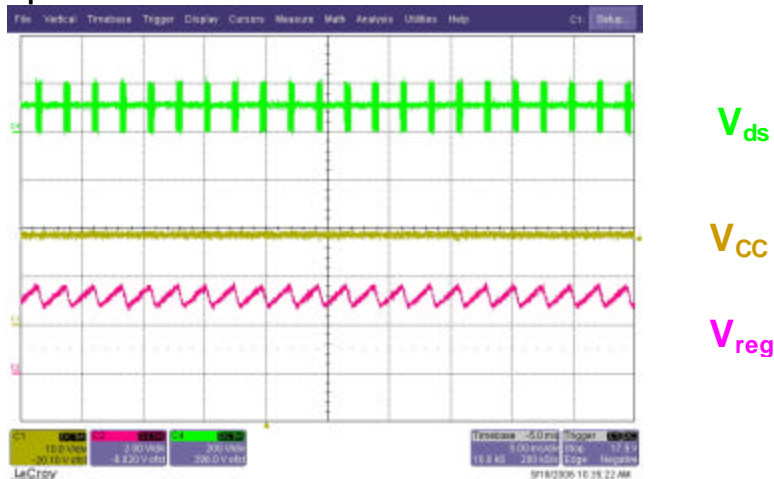

160W SMPS Evaluation Board with Quasi Resonant Controller ICE2QS01

Leaving active burst mode

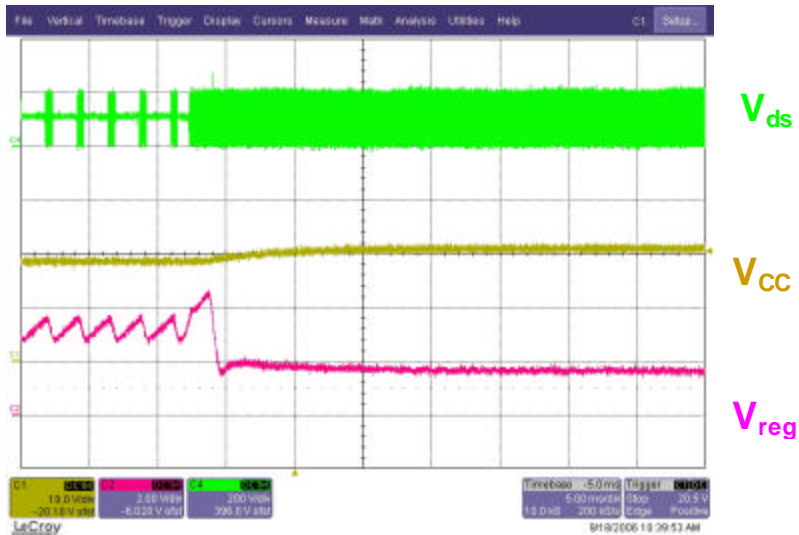

13 References

- [1] Infineon Technologies, “ICE2QS01 Quasi-resonant PWM controller”, Infineon Technologies Datasheet, version 1.0, September 2006.