



CER6080

Dual Enhancement Mode Field Effect Transistor (N and P Channel)

FEATURES

- 60V, 5.6A, $R_{DS(ON)} = 45m\Omega$ @ $V_{GS} = 10V$.
 $R_{DS(ON)} = 75m\Omega$ @ $V_{GS} = 4.5V$.
- -60V, -3.3A, $R_{DS(ON)} = 130m\Omega$ @ $V_{GS} = -10V$.
 $R_{DS(ON)} = 180m\Omega$ @ $V_{GS} = -4.5V$.
- Super high dense cell design for extremely low $R_{DS(ON)}$.
- High power and current handing capability.
- Lead free product is acquired.

DIP-8

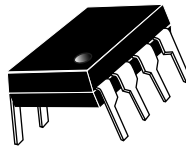

1

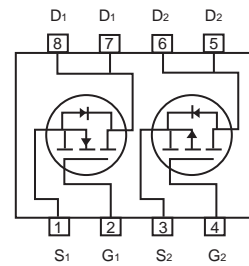

ABSOLUTE MAXIMUM RATINGS $T_A = 25^\circ\text{C}$ unless otherwise noted

Parameter	Symbol	N-Channel	P-Channel	Units
Drain-Source Voltage	V_{DS}	60	-60	V
Gate-Source Voltage	V_{GS}	± 20	± 20	V
Drain Current-Continuous	I_D	5.6	-3.3	A
Drain Current-Pulsed ^a	I_{DM}	20	-15	A
Maximum Power Dissipation	P_D	2.5		W
Operating and Store Temperature Range	T_J, T_{stg}	-55 to 150		$^\circ\text{C}$

Thermal Characteristics

Parameter	Symbol	Limit	Units
Thermal Resistance, Junction-to-Ambient ^b	$R_{\theta JA}$	50	$^\circ\text{C/W}$



N-Channel Electrical Characteristics $T_A = 25\text{ C}$ unless otherwise noted

Parameter	Symbol	Test Condition	Min	Typ	Max	Units
Off Characteristics						
Drain-Source Breakdown Voltage	BV_{DSS}	$V_{GS} = 0V, I_D = 250\mu A$	60			V
Zero Gate Voltage Drain Current	I_{DSS}	$V_{DS} = 60V, V_{GS} = 0V$			1	μA
Gate Body Leakage Current, Forward	I_{GSSF}	$V_{GS} = 20V, V_{DS} = 0V$			100	nA
Gate Body Leakage Current, Reverse	I_{GSSR}	$V_{GS} = -20V, V_{DS} = 0V$			-100	nA
On Characteristics						
Gate Threshold Voltage	$V_{GS(th)}$	$V_{GS} = V_{DS}, I_D = 250\mu A$	1		3	V
Static Drain-Source On-Resistance	$R_{DS(on)}$	$V_{GS} = 10V, I_D = 5.6A$		35	45	$m\Omega$
		$V_{GS} = 4.5V, I_D = 4.4A$		60	75	$m\Omega$
Dynamic Characteristics ^c						
Forward Transconductance	g_{FS}	$V_{DS} = 15V, I_D = 5.6A$		14		S
Input Capacitance	C_{iss}	$V_{DS} = 30V, V_{GS} = 0V, f = 1.0\text{ MHz}$		750		pF
Output Capacitance	C_{oss}			105		pF
Reverse Transfer Capacitance	C_{rss}			65		pF
Switching Characteristics ^c						
Turn-On Delay Time	$t_{d(on)}$	$V_{DD} = 30V, I_D = 4.4A, V_{GS} = 10V, R_{GEN} = 1\Omega$		15	30	ns
Turn-On Rise Time	t_r			4	15	ns
Turn-Off Delay Time	$t_{d(off)}$			37	80	ns
Turn-Off Fall Time	t_f			5	15	ns
Total Gate Charge	Q_g	$V_{DS} = 30V, I_D = 5.6A, V_{GS} = 10V$		22	29	nC
Gate-Source Charge	Q_{gs}			3.0		nC
Gate-Drain Charge	Q_{gd}			4.5		nC
Drain-Source Diode Characteristics and Maximum Ratings						
Drain-Source Diode Forward Current	I_S				5.6	A
Drain-Source Diode Forward Voltage ^b	V_{SD}	$V_{GS} = 0V, I_S = 1.3A$			1.2	V
Notes : a.Repetitive Rating : Pulse width limited by maximum junction temperature. b.Pulse Test : Pulse Width $\leq 300\mu s$, Duty Cycle $\leq 2\%$. c.Guaranteed by design, not subject to production testing.						



P-Channel Electrical Characteristics $T_A = 25\text{ C}$ unless otherwise noted

Parameter	Symbol	Test Condition	Min	Typ	Max	Units
Off Characteristics						
Drain-Source Breakdown Voltage	BV_{DSS}	$V_{GS} = 0V, I_D = -250\mu A$	-60			V
Zero Gate Voltage Drain Current	I_{DSS}	$V_{DS} = -60V, V_{GS} = 0V$			-1	μA
Gate Body Leakage Current, Forward	I_{GSSF}	$V_{GS} = 20V, V_{DS} = 0V$			100	nA
Gate Body Leakage Current, Reverse	I_{GSSR}	$V_{GS} = -20V, V_{DS} = 0V$			-100	nA
On Characteristics						
Gate Threshold Voltage	$V_{GS(th)}$	$V_{GS} = V_{DS}, I_D = -250\mu A$	-1		-3	V
Static Drain-Source On-Resistance	$R_{DS(on)}$	$V_{GS} = -10V, I_D = -3.3A$		105	130	$m\Omega$
		$V_{GS} = -4.5V, I_D = -2.6A$		135	180	$m\Omega$
Dynamic Characteristics ^c						
Forward Transconductance	g_{FS}	$V_{DS} = -15V, I_D = -3.3A$		8		S
Input Capacitance	C_{iss}	$V_{DS} = -30V, V_{GS} = 0V, f = 1.0\text{ MHz}$		890		pF
Output Capacitance	C_{oss}			85		pF
Reverse Transfer Capacitance	C_{rss}			85		pF
Switching Characteristics ^c						
Turn-On Delay Time	$t_{d(on)}$	$V_{DD} = -30V, I_D = -1A, V_{GS} = -10V, R_{GEN} = 6\Omega$		11	20	ns
Turn-On Rise Time	t_r			3	5	ns
Turn-Off Delay Time	$t_{d(off)}$			30	60	ns
Turn-Off Fall Time	t_f			4	10	ns
Total Gate Charge	Q_g	$V_{DS} = -30V, I_D = -3.3A, V_{GS} = -10V$		10.7	14	nC
Gate-Source Charge	Q_{gs}			2.1		nC
Gate-Drain Charge	Q_{gd}			1.1		nC
Drain-Source Diode Characteristics and Maximum Ratings						
Drain-Source Diode Forward Current	I_S				-3.3	A
Drain-Source Diode Forward Voltage ^b	V_{SD}	$V_{GS} = 0V, I_S = -1.3A$			-1.2	V
Notes : a.Repetitive Rating : Pulse width limited by maximum junction temperature. b.Pulse Test : Pulse Width $\leq 300\mu s$, Duty Cycle $\leq 2\%$. c.Guaranteed by design, not subject to production testing.						



N-CHANNEL

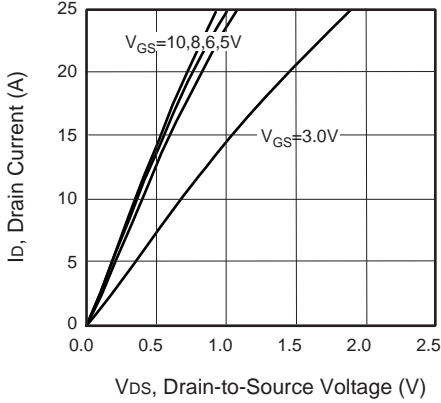

Figure 1. Output Characteristics

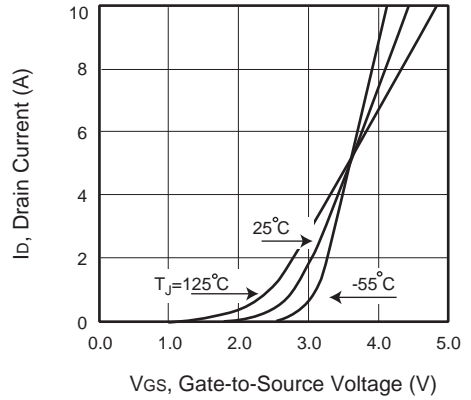

Figure 2. Transfer Characteristics

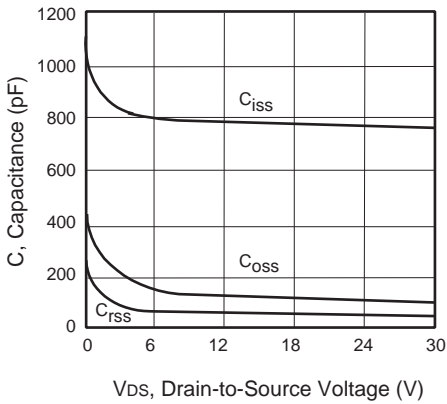

Figure 3. Capacitance

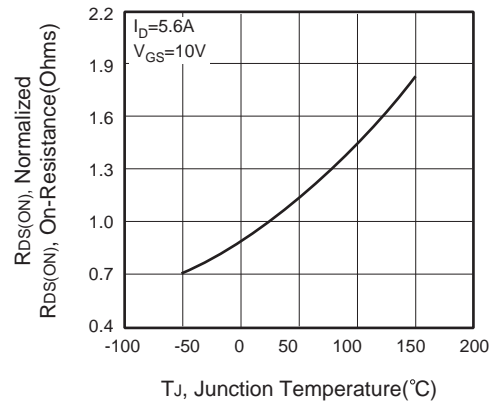

Figure 4. On-Resistance Variation with Temperature

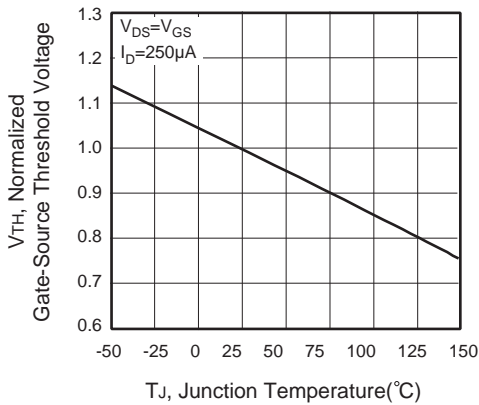

Figure 5. Gate Threshold Variation with Temperature

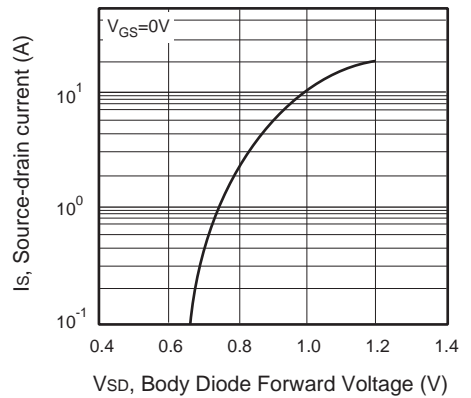

Figure 6. Body Diode Forward Voltage Variation with Source Current



P-CHANNEL

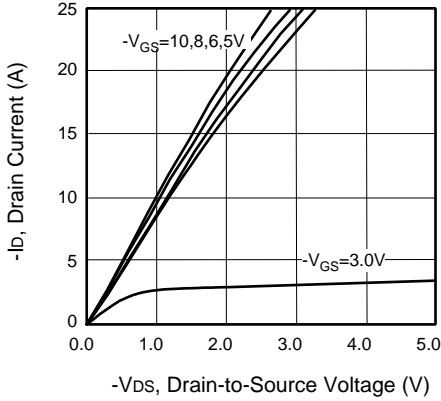

Figure 7. Output Characteristics

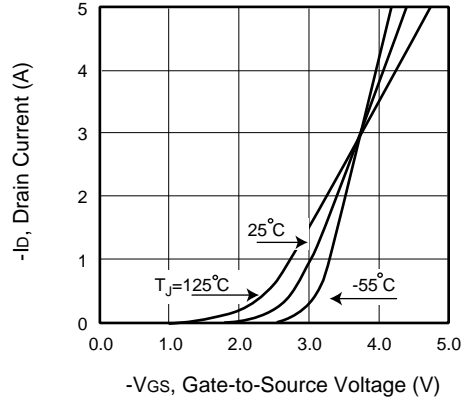

Figure 8. Transfer Characteristics

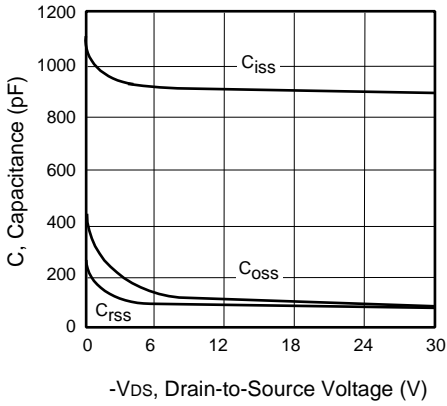

Figure 9. Capacitance

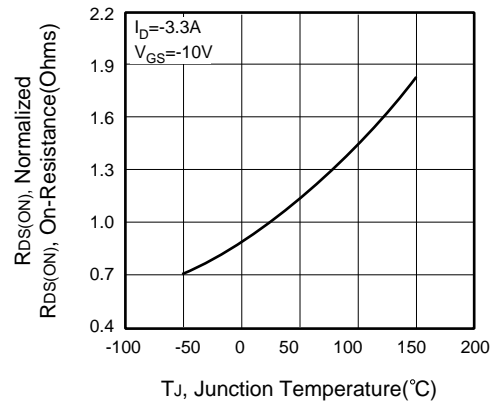

Figure 10. On-Resistance Variation with Temperature

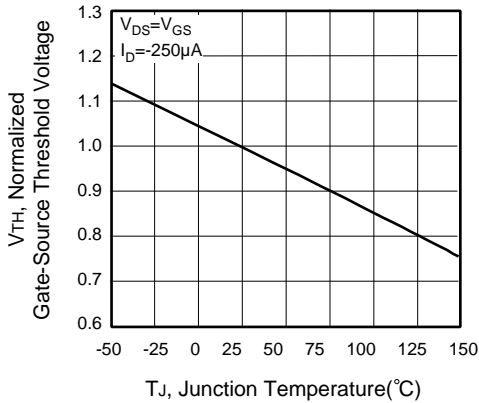

Figure 11. Gate Threshold Variation with Temperature

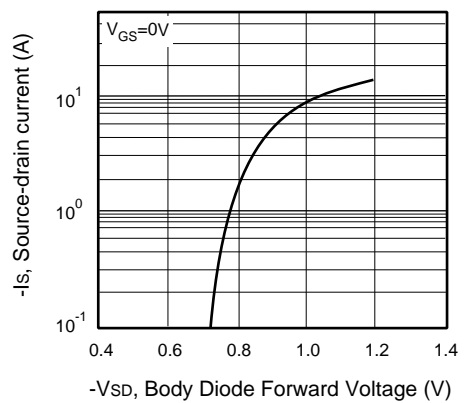

Figure 12. Body Diode Forward Voltage Variation with Source Current



N-CHANNEL

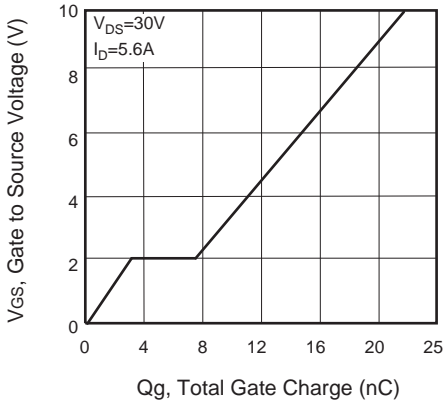

Figure 13. Gate Charge

P-CHANNEL

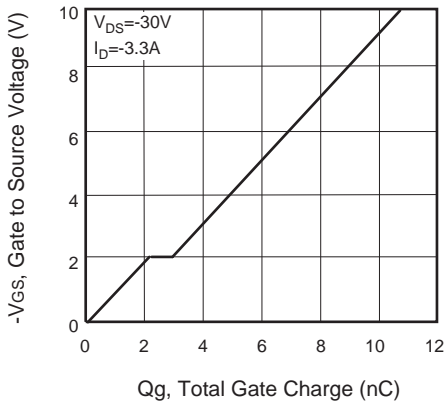

Figure 15. Gate Charge

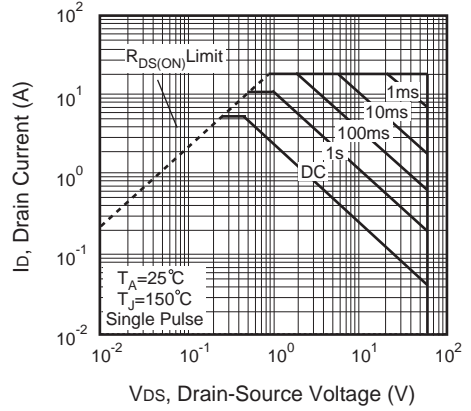

Figure 14. Maximum Safe Operating Area

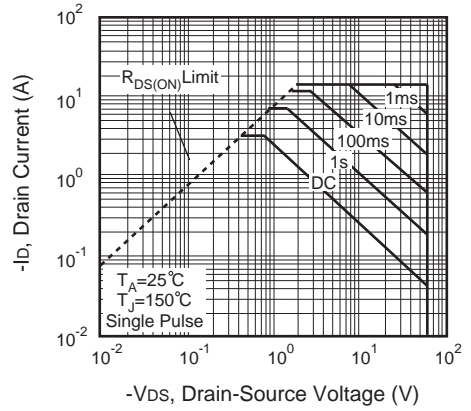

Figure 16. Maximum Safe Operating Area

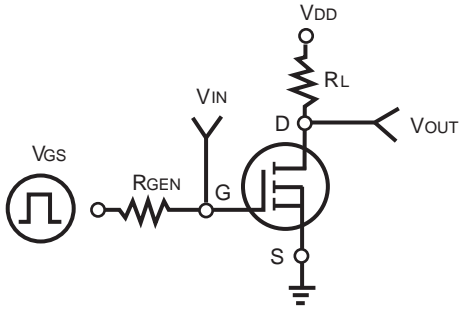

Figure 17. Switching Test Circuit

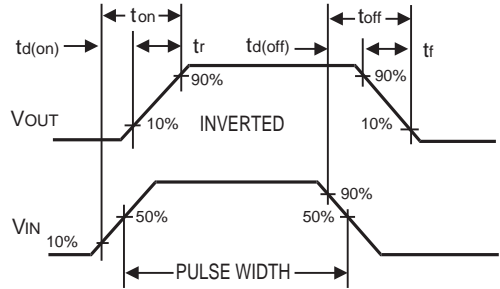

Figure 18. Switching Waveforms

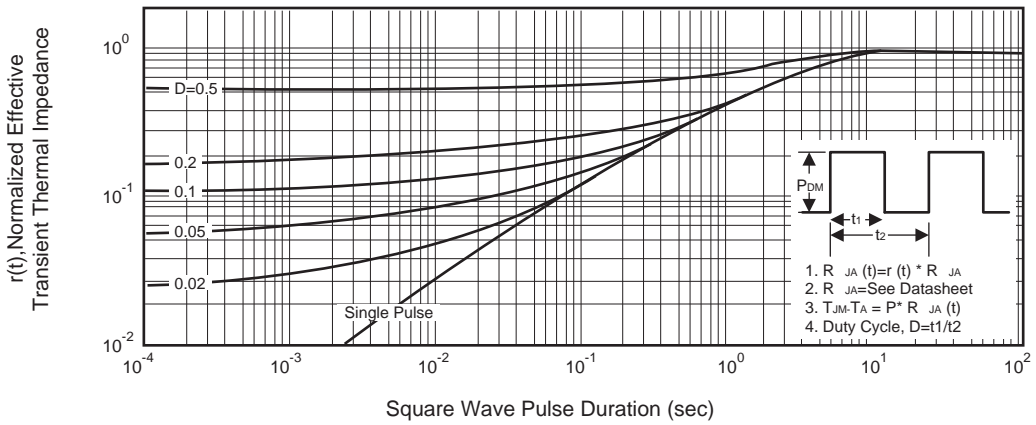

Figure 19. Normalized Thermal Transient Impedance Curve