

HAS-0802/1002/1202

FEATURES

- Conversion Times as Low as $1.2\mu\text{s}$
- Resolution: 8, 10 and 12 Bits
- Exceptional Accuracy, 0.012% of F.S.
- Low Power
- Contained in Glass or Metal 32-Pin DIP
- Adjustment-Free Operation

APPLICATIONS

- Waveform Analysis
- Fast Fourier Transforms
- Radar

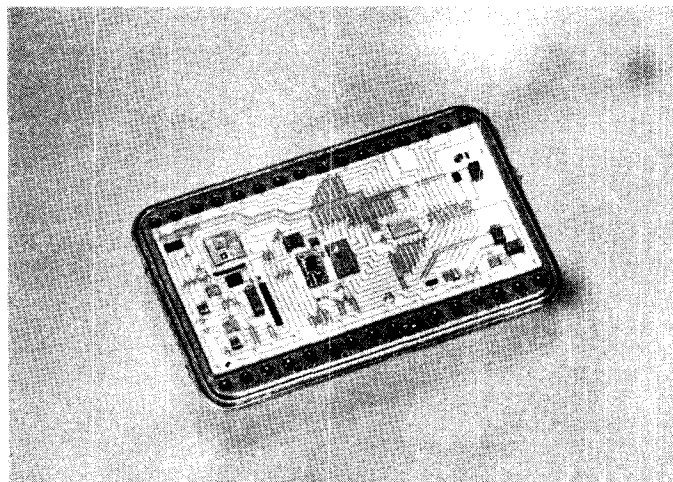

GENERAL DESCRIPTION

With a typical conversion time of only $2.2\mu\text{s}$ for complete 12-bit conversion, the Analog Devices' HAS series hybrid A/D converters are the fastest, smallest, most complete successive-approximation A/D's available. Housed in 32-pin DIP packages, these converters feature laser trimming for accuracy and linearity surpassing the best modular competitive A/D's. This series offers a unique combination of flexibility and simplicity which allows them to be used as stand-alone A/D converters requiring no additional external potentiometers and needing only an analog input signal and encode command for operation.

The HAS-1202 A/D features an accuracy of 0.012% and when combined with an HTC-0300 track-and-hold, forms an A/D conversion system capable of up to 350kHz sampling rates.

The HAS series A/D's are ideally suited for applications requiring excellent performance characteristics, small size, low power consumption and adjustment-free operation. Some of these applications include radar, PCM, data-acquisition, and digital-signal-processing systems where FFT's and other digital processing techniques are to be performed on analog input data.

For the ultra-high reliability requirements of military and aerospace applications these A/D's are optionally available with hermetically sealed metal cases and with MIL-STD-883 processing.

Extreme care in circuit layout should be exercised when using these hybrids in order to obtain rated performance. In particular, input and output runs should be as short as possible, a ground plane should be used to tie all ground pins together, and power supplies should be bypassed as close to the hybrid

circuit power supply pins as possible. Do not allow input or other analog signal lines to be in close proximity to or cross over any digital output line.

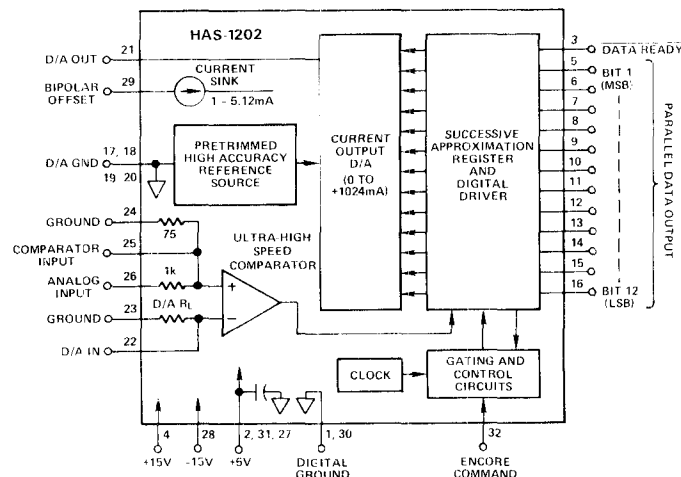

NOTES: 1. FUNCTIONAL CONFIGURATION SHOWN IS FOR THE HAS 1202. FOR THE HAS 1002 PINS 15 AND 16 ARE NOT CONNECTED INTERNALLY. FOR HAS 0802 PINS 13, 14, 15 AND 16 ARE NOT CONNECTED INTERNALLY.
2. FOR BIPOLAR OPERATION, CONNECT PIN 21 TO PIN 29. FOR UNIPOLAR OPERATION, LEAVE PIN 21 OPEN AND GROUND PIN 29.

Block Diagram — HAS Series

SPECIFICATIONS (typical @ +25°C with nominal voltages unless otherwise noted)

MODEL	UNITS	HAS-0802	HAS-1002	HAS-1202
RESOLUTION	BITS	8	10	12
LSB Weight	% Full Scale	0.4	0.1	0.025
	mV	40	10	2.5
RELATIVE ACCURACY (INCLUDING LINEARITY)	% Full Scale	0.05	0.025	0.012
Quantization Error	LSB	±1/2	*	*
LINEARITY VS. TEMPERATURE	ppm/°C	3	*	*
		(No Missing Codes over Temperature Range)		
INPUT OFFSET VOLTAGE				
Initial (Trimable to Zero)	mV	10	*	*
Zero Offset vs. Temperature	µV/°C	15	*	*
Bipolar Offset vs. Temperature	µV/°C	100	*	*
GAIN ERROR				
Initial (Trimable to Zero)	% Full Scale	0.1	*	*
Gain vs. Temperature	ppm/°C	30	*	*
INPUT				
Ranges (Full Scale)				
“Built-In” Standard Unipolar	V ±0.1%	+10.24	*	*
Bipolar	V ±0.05%	±5.12	*	*
Resistor Programmable (See Figure 3)	V, 0 to:	+5, +7.5, +15, +20, ±2.5, ±3.75, ±7.5, ±10		
Impedance	Ω min	1000	*	*
Overvoltage	V	Two Times Full Scale + or -		
CONVERSION TIME (COMPLETE CYCLE TIME)	µs max (typ)	1.5 (1.2)	1.7 (1.4)	2.8 (2.2)
CONVERSION RATE	kHz max	667	558	357
ENCODE COMMAND – TTL LOGIC INPUT				
Logic Levels (Positive Logic) Function ¹	V	“0” = 0 to +0.4, “1” = +2 to +5 Logic “1” Resets Converter Logic “0” Starts Conversion		
Loading		1 Standard TTL Load: “0” = -1.6mA, max “1” = 40µA, max		
Pulse Width	ns min	100	*	*
Repetition Rate		0 to Maximum Conversion Rate		
LOGIC OUTPUTS				
Data Ready (DR) Function		Signals conversion is complete when low. After DR goes low, data is valid. A new conversion may be initiated at this time. DR may be used to strobe data into external register if adequate register setup time is allowed. See Figure 1		
Timing Loading Parallel Data Format		5 Standard TTL Loads, max		
Logic Levels		8-, 10-, or 12-bits parallel data. Valid from time DR output goes low until 20ns after receipt of next encode command. TTL Compatible: “0” = 0V to +0.4V “1” = +2.4V to +5V		
Loading		Will drive up to 5 Standard TTL Loads or 2 TTL “S” or “H” Loads.		
Coding ²		Offset Binary (BIN) for Unipolar Inputs: +10.24V = 1 1 1 1 1 0V = 0 0 0 0 0 Offset Binary (OBN) for Bipolar Inputs: +5.12V = 1 1 1 1 1 0V = 0 1 1 1 1 -5.12V = 0 0 0 0 0		
POWER REQUIREMENTS				
+14.5V to +15.5V (+18V Absolute Max)	mA	40	*	*
-14.5V to -15.5V (-18V Absolute Max)	mA	15	*	*
+4.75V to +5.25V (+7V Absolute Max)	mA	200	*	*
TEMPERATURE RANGE				
Operating	°C	0 to +70	*	*
Storage	°C	-55 to +125	*	*

NOTES:

¹After converter is reset, all other logic signals, including clock, are internally generated.

²When HAS series A/D's are used with HTC-0300 track/hold, output coding is complementary binary (CBN) for unipolar inputs and complementary offset binary (COB) for bipolar inputs (see Table 1).

*Specifications same as model HAS-0802.
Specifications subject to change without notice.

Table 1. Output Coding*

SCALE	INPUT OF HTC-0300	INPUT OF HAS-1202	DIGITAL OUTPUT
UNIPOLAR OPERATION			
FS-1LSB	-10.2375V	+10.2375V	111111111111
3/4 FS	- 7.6800V	+ 7.6800V	110000000000
1/2 FS	- 5.1200V	+ 5.1200V	100000000000
1/4 FS	- 2.5600V	+ 2.5600V	010000000000
+1LSB	- 0.0025V	+ 0.0025V	000000000001
0	0.0000V	0.0000V	000000000000
BIPOLAR OPERATION			
+FS-1LSB	- 5.1175V	+ 5.1175V	111111111111
0	0.0000V	0.0000V	100000000000
-FS+1LSB	+ 5.1175V	- 5.1175V	000000000001
-FS	+ 5.1200V	- 5.1200V	000000000000

*Coding and input levels shown are for HAS-1202. For 8- and 10-bit A/D's the input levels are less by the values of the LSB weight for each type, and the digital output will show only 8 or 10 bits, respectively.

OUTLINE DIMENSIONS

Dimensions shown in inches and (mm).

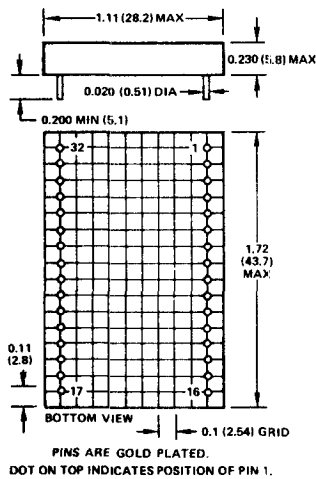

GLASS PACKAGE

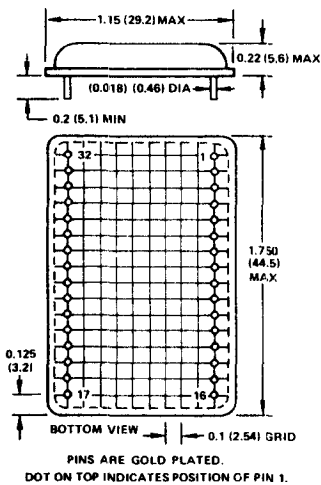

**METAL PACKAGE (M)
(OPTIONAL)**

PIN DESIGNATIONS

HAS-1202*

PIN	FUNCTION
1, 30	DIGITAL GROUND
2, 27, 31	+5V
3	DATA READY
4	+15V
5	BIT 1 OUTPUT (MSB)
6	BIT 2 OUTPUT
7	BIT 3 OUTPUT
8	BIT 4 OUTPUT
9	BIT 5 OUTPUT
10	BIT 6 OUTPUT
11	BIT 7 OUTPUT
12	BIT 8 OUTPUT
13	BIT 9 OUTPUT
14	BIT 10 OUTPUT
15	BIT 11 OUTPUT
16	BIT 12 OUTPUT (LSB)
17, 18, 19	ANALOG GROUND
20, 23, 24	ANALOG GROUND
25	COMP INPUT
26	ANALOG INPUT
28	-15V
29	BIPOLAR OFFSET
32	ENCODE COMMAND

*HAS-1002, PINS 15 AND 16 ARE NOT CONNECTED INTERNALLY.
HAS-0802, PINS 13, 14, 15 AND 16 ARE NOT CONNECTED INTERNALLY.

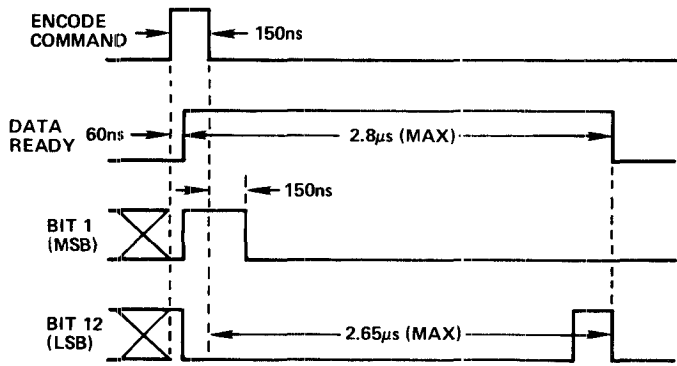

TIMING SHOWN FOR HAS-1202. TIMING IS SIMILAR FOR HAS-1002 AND HAS-0802 EXCEPT LSB IS BIT 10 AND 8, RESPECTIVELY, AND TOTAL TYPICAL CONVERSION TIME IS 1.4µs AND 1.2µs, RESPECTIVELY.

Figure 1. Timing Diagram (Typical)

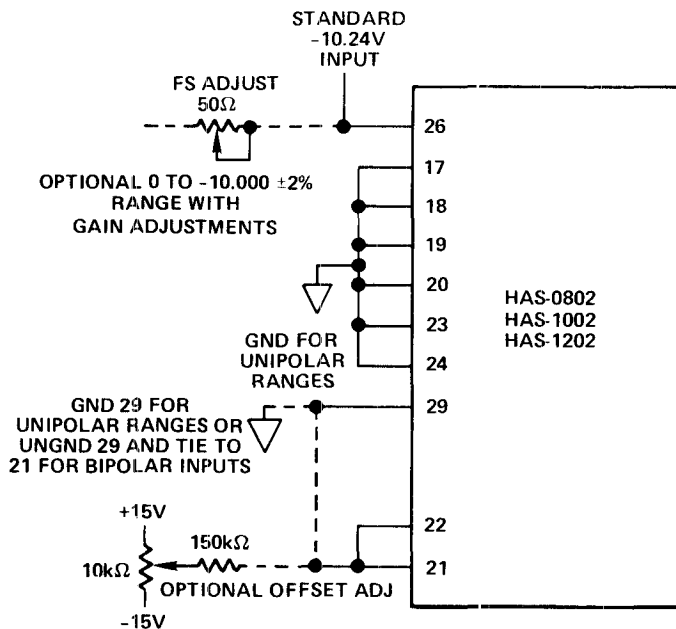

- NOTES:
1. THIS CIRCUIT SHOWN FOR UNIPOLAR (0 TO -10.24V) INPUT. 0V INPUT = 000000000000; -10.24 INPUT = 111111111111.
 2. FOR BIPOLAR ($\pm 5.12V$) INPUT, UNGROUND PIN 29 AND CONNECT PIN 29 TO PIN 21.
 3. FOR EXTRA-PRECISE GAIN (FULL-SCALE) ADJUSTMENT, CONNECT A 50Ω VARIABLE RESISTANCE IN SERIES WITH PIN 20 OF HAS-1202. THIS WILL RESULT IN 0 TO -10.000V INPUT WITH ADJUSTMENT RANGE OF $\pm 2\%$ OF FULL SCALE.
 4. FOR EXTRA-PRECISE ZERO OFFSET ADJUSTMENT, CONNECT 150k RESISTOR FROM PIN 21 TO THE TAP OF A 10k POTENTIOMETER. END TERMINATIONS OF POTENTIOMETER CONNECT TO +15V AND -15V. THIS ZERO OFFSET ADJUSTMENT WILL HAVE A RANGE OF APPROXIMATELY $\pm 100mV$.

Figure 2. Input Connections For Standard Input Ranges

Input Connections For Optional Input Ranges

INPUT RANGE	R1	R2	Z _{IN}	ABSOLUTE MAXIMUM SIGNAL
0 to +5V, $\pm 2.5V$	SHORT	1000	500	$\pm 10V$
0 to +7.5V, $\pm 3.75V$	SHORT	3000	750	$\pm 15V$
0 to +15V, $\pm 7.5V$	500	OPEN	1500	$\pm 30V$
0 to +20V, $\pm 10V$	1000	OPEN	2000	$\pm 40V$

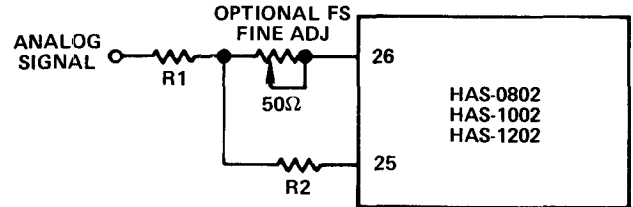

Figure 3. Full Scale Trim

APPLICATION CIRCUIT

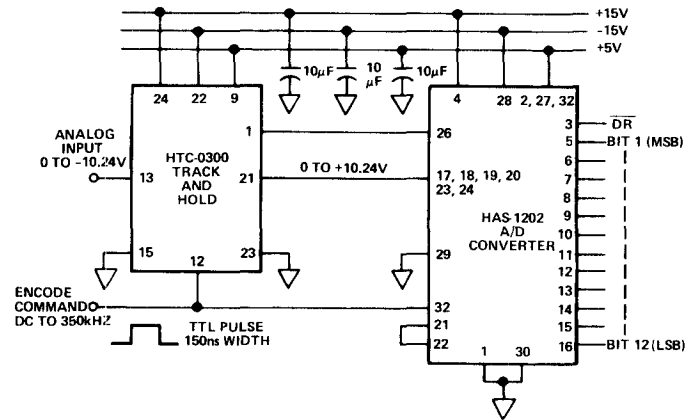

Figure 4. DC to 350kHz, 12-Bit, A/D Conversion System

ORDERING INFORMATION

Order model number HAS-0802, HAS-1002, or HAS-1202 for 8-, 10-, or 12-bit operation, respectively. Mating connector for the HAS series A/D's is model number HSA-2. Metal cased versions of this A/D with extended operating temperature range, and MIL-STD processing are also available. Consult the factory or nearest Analog Devices' sales office for further information.