



iT3021 2.5 Gb/s High-Sensitivity Limiter Amplifier

Description

The iT3021 is a limiting amplifier for use as a post amplifier in optical receivers. Signals as small as +/-7 mVpp differential can be amplified to 1.28 Vpp differential. Offset correction and output voltage control are provided. Both AC and DC coupling are allowed at the input and output. The high sensitivity allows the device to be used at the output of a transimpedance amplifier.

Features

- ❖ 3-dB bandwidth: 2.5 GHz
- ❖ Differential gain: 42 dB
- ❖ Saturated output: 640 mVpp on each output into 50 ohms
- ❖ Single bias supply: -5.2 V
- ❖ Power consumption: 494 mW
- ❖ Bias current: 95 mA
- ❖ DC offset correction
- ❖ Amplitude voltage control
- ❖ Low RMS jitter
- ❖ Low-cost JEDEC QFP-N (MO-220) package

Absolute Maximum Ratings

Symbol	Parameters/conditions	Min.	Max.	Units
Vee1,2	Power supply voltage	-8	0	V
Vd	Applied voltage at data input (differential)		3	V
Vm	Applied voltage at data input (single ended)		1.5	V
Ioffset(+),(-)	Offset control current		5	mA
Tch	Maximum channel temperature		150	°C
Tstg	Storage temperature	-65	150	°C

Recommended Operating Conditions

Symbol	Parameters/conditions	Min.	Typ.	Max.	Units
Tc	Operating temperature range (Tcase)	0		85	°C
Vee1	Power supply voltage	-5.45	-5.2	-4.95	V
Vee2	Power supply voltage	-5.45	-5.2	-4.95	V
Iee1+Iee2	Total bias supply current	80	95	110	mA
Voffset (+)	Offset control voltage	-5		5	V
Voffset (-)	Offset control voltage	-5		5	V
Vctrl	Amplitude voltage control	-5.2		0	V
Vd	Applied peak to peak voltage at data input (differential)	7		1000	mV
Vm	Applied peak to peak voltage at data input (single ended)	14		1000	mV
	Input/output interface	AC and DC coupled			
Vindc	DC input voltage (with DC-coupled input)	-0.5		0.5	V

Electrical Characteristics

At ambient temperature
Vee1,2 = -5.2 V

Symbol	Parameters/conditions	Min.	Typ.	Max.	Units
P	Power consumption	416	494	572	mW
G	Differential small signal gain	41	42		dB
B3dB	3 dB bandwidth	2.3	2.5		GHz
RLin	Input return loss (up to 5 GHz)	15	20		dB
RLout	Output return loss (up to 5 GHz)	15	20		dB
Vin	Input sensitivity diff. input (BER<1E-12, 2 ²³ -1PRBS, 2.5Gb/s)		4		mVpp
Vout	Output peak to peak voltage (either Q or /Q) (Vctrl=0V for max. output voltage)	590	640		mVpp
ΔVout	Vout sensitivity vs. bias (Vee=-5.2 V +/-5%)			+/-11	%
Voutdc	Output DC voltage (DC coupled to 50 ohm load)	-450	-350	-250	mV
Trse	Rise time (20% - 80%)		45	60	ps
Tfse	Fall time (20% - 80%)		45	60	ps
Jpp	Jitter peak to peak		9	14	ps

S-Parameter Data

(Measured on connectorized evaluation board)

Vee1 = Vee2 = -5.2 V
Iee1+Iee2 = 95 mA

iT3021 Single Ended Gain

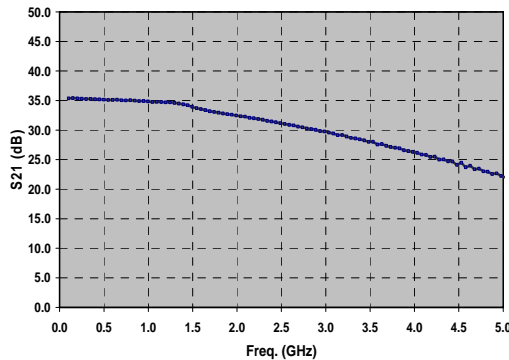

iT3021 Input Return Loss

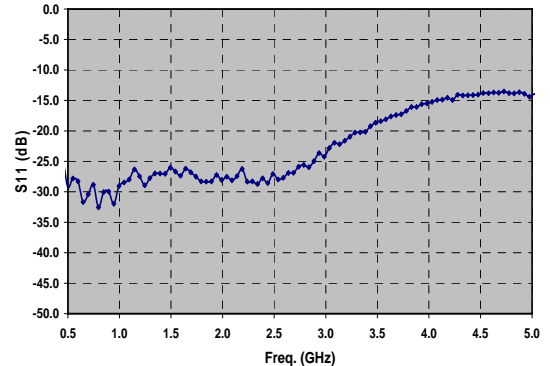

iT3021 Output Return Loss

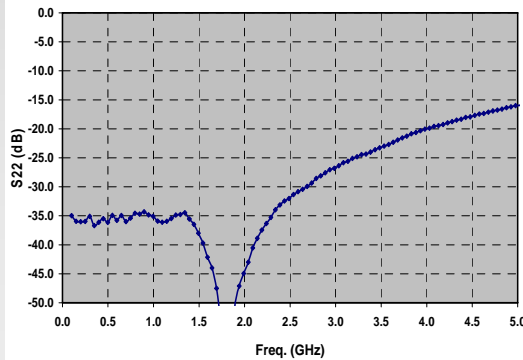

iT3021 Isolation

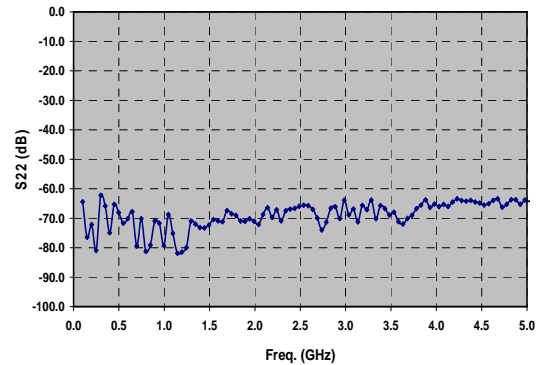

Eye Diagram Performance

Vee1 = Vee2 = -5.2 V
Iee1 + Iee2 = 95 mA

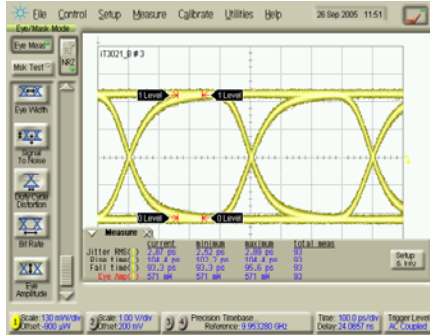

Bit rate: 2.5 Gb/s
Vin = +/-6 mVpp, Vout = +/-570 mVpp

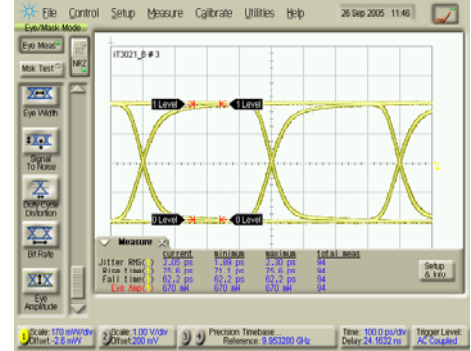

Bit rate: 2.5 Gb/s
Vin = +/-10 mVpp, Vout = +/-670 mVpp

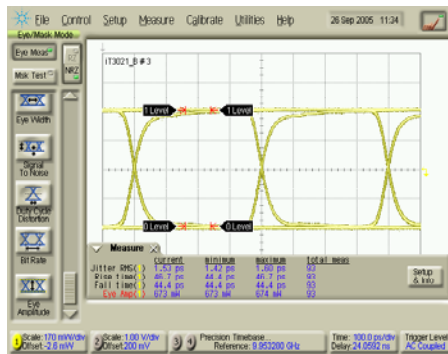

Bit rate: 2.5 Gb/s
Vin = +/-50 mVpp, Vout = +/-672 mVpp



Bit rate: 2.5 Gb/s
Vin = +/-100 mVpp, Vout = +/-672 mVpp

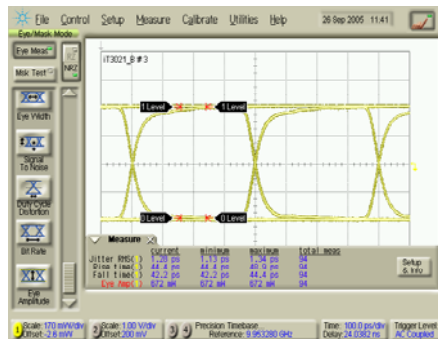

Bit rate: 2.5 Gb/s
Vin = +/-200 mVpp, Vout = +/-672 mVpp

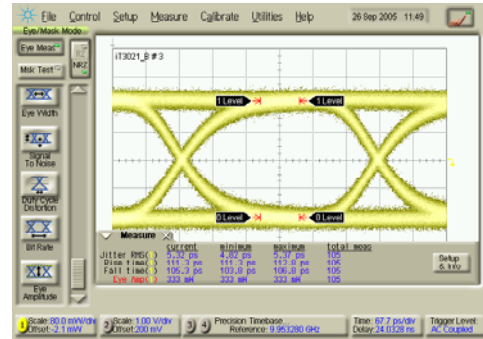

Input sensitivity = +/-3 mVpp differential input, 2.5 Gb/s
Output voltage = 333 mVpp single-ended

Performance As Function of Input Voltage

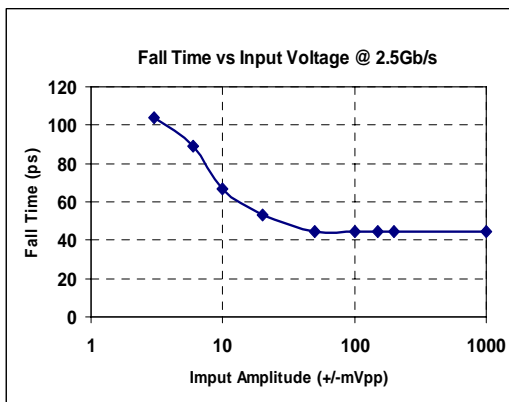
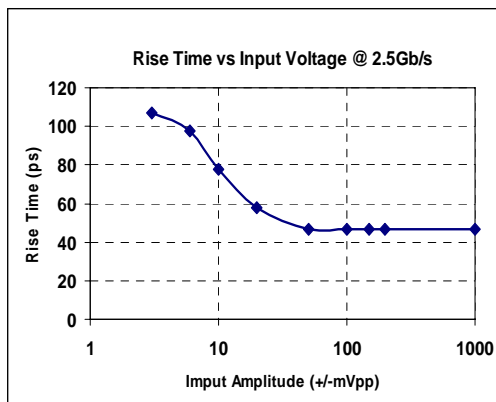
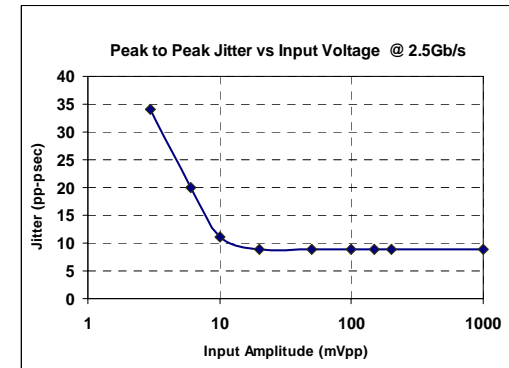
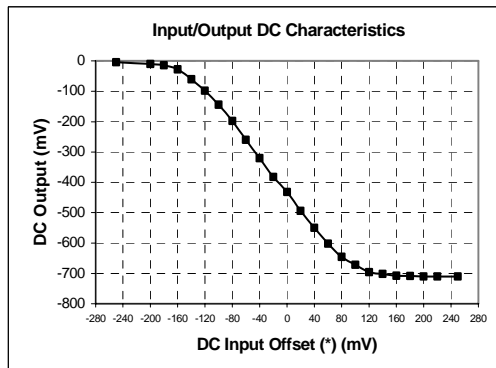
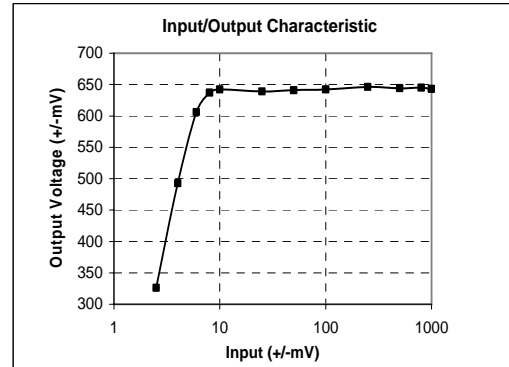
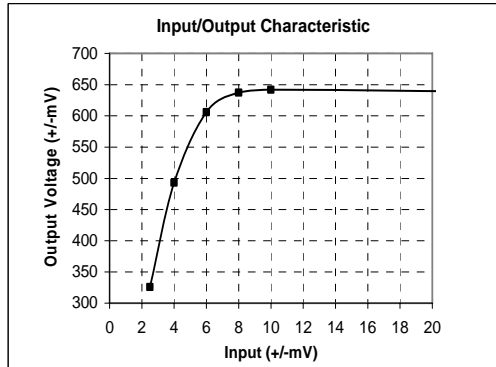

(*) Input applied to the offset control pin (Voffset1) and open output.

Output Voltage Control

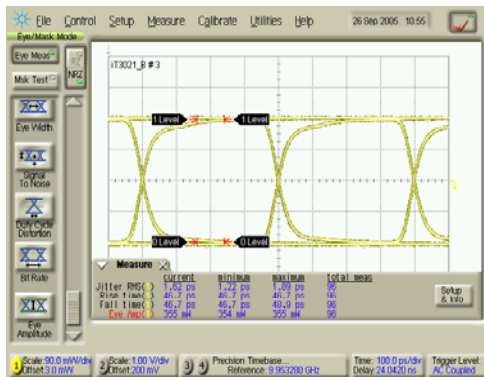
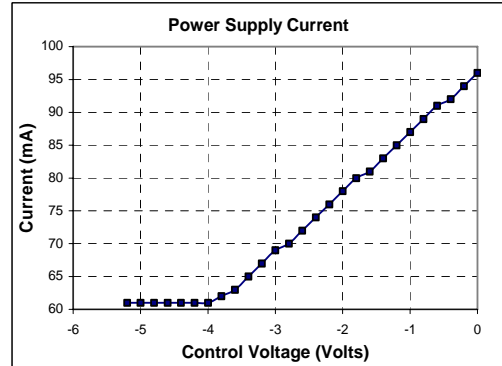
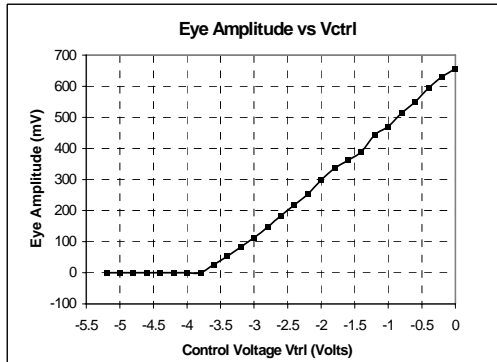

Bit rate: 2.5 Gb/s, Vctrl = -1.7 V
Vin = +/-200 mVpp, Vout = +/-355 mVpp

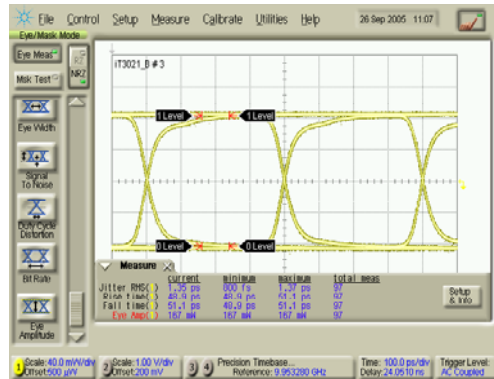

Bit rate: 2.5 Gb/s, Vctrl = -2.7 V
Vin = +/-200 mVpp, Vout = +/-167mVpp

Recommended Operational Setup

Apply -5.2 V at Vee1 and Vee2
Apply 0 V at Vctrl
for maximum output

DC blocking capacitors optional

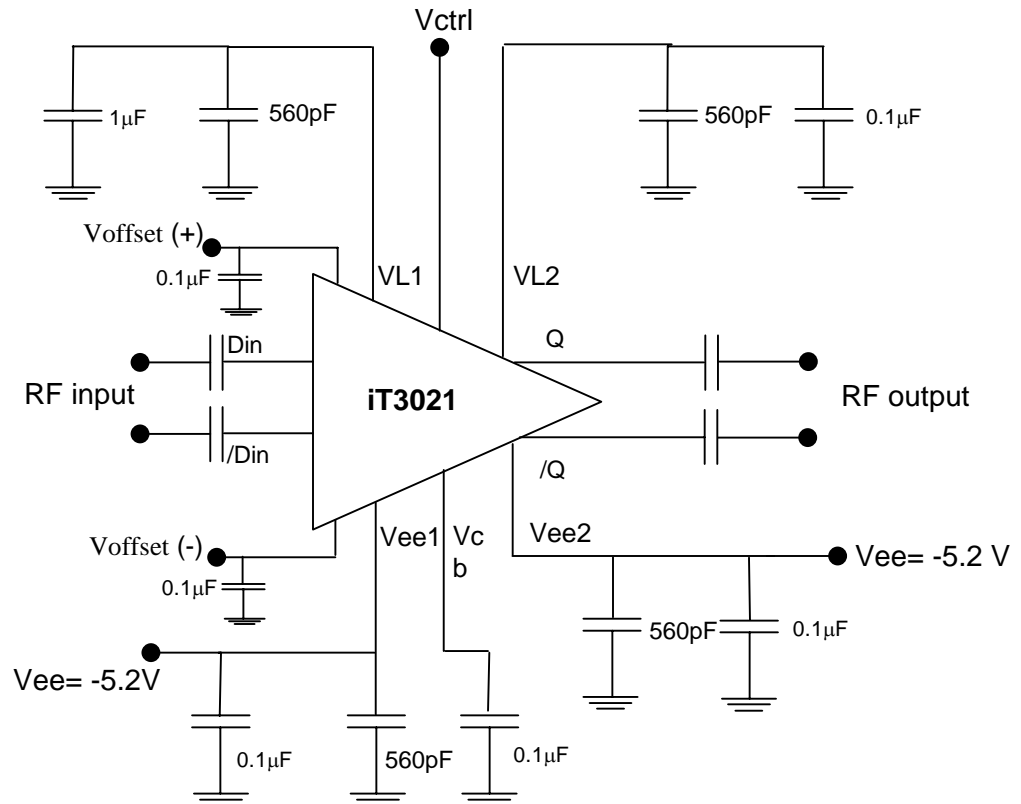

Package
Drawings,
Pinouts

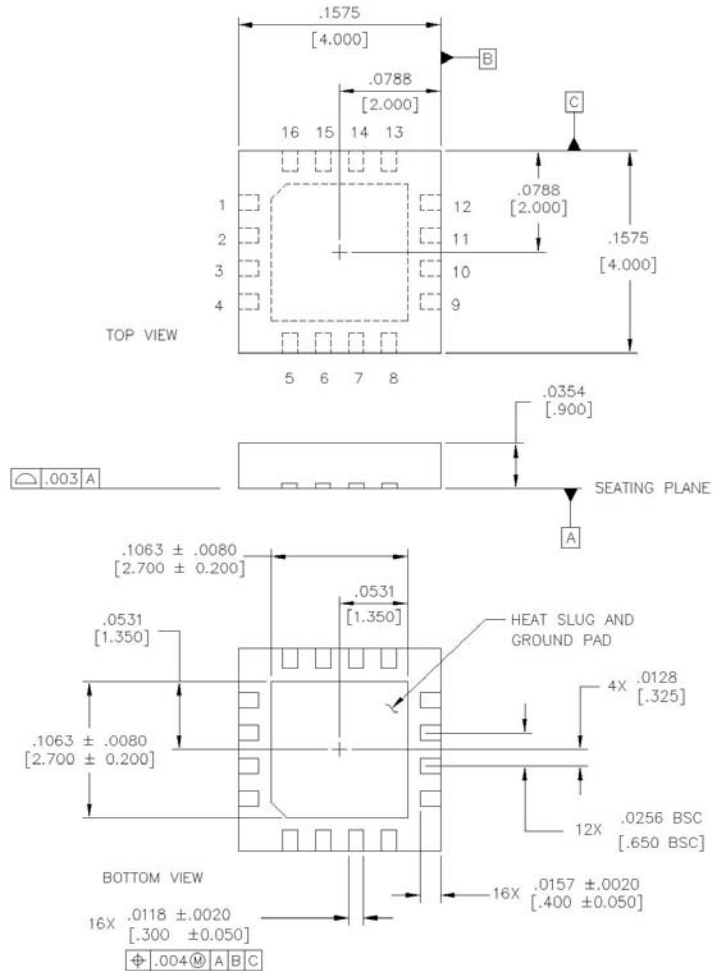

Pinouts:

P1: GND	P9: GND
P2: Din (RF input)	P10: /Q (/RF Out)
P3: /Din (/RF input)	P11: Q (RF Out)
P4: GND	P12: GND
P5: Voffset (-)	P13: VL1
P6: Vee1	P14: Vctrl (voltage control)
P7: Vcb	P15: VL2
P8: Vee2	P16: Voffset (+)

NOTES: (UNLESS OTHERWISE SPECIFIED)

1. DIMENSIONS: INCHES [mm]
2. EXCEPT WHERE NOTED, TOLERANCE ON DIMENSIONS ARE: ± .0039 [0.100]