

FEATURES

- * 1.2 inch (30.42 mm) MATRIX HEIGHT.
- * LOW POWER REQUIREMENT.
- * SINGLE PLANE, WIDE VIEWING ANGLE.
- * SOLID STATE RELIABILITY.
- * 5 × 7 ARRAY WITH X-Y SELECT.
- * COMPATIBLE WITH USASCII AND EBCDIC CODES.
- * STACKABLE HORIZONTALLY.
- * CATEGORIZED FOR LUMINOUS INTENSITY.

DESCRIPTION

The LTP-1557AG-01 is a 1.2 inch (30.42 mm) matrix height 5 × 7 dot matrix display. This device utilizes green LED chips, which are made from GaP on a transparent GaP substrate, and has a black face and white dot color.

DEVICE

PART NO.	DESCRIPTION
GREEN	CATHODE COLUMN
LTP-1557AG-01	ANODE ROW

PACKAGE DIMENSIONS

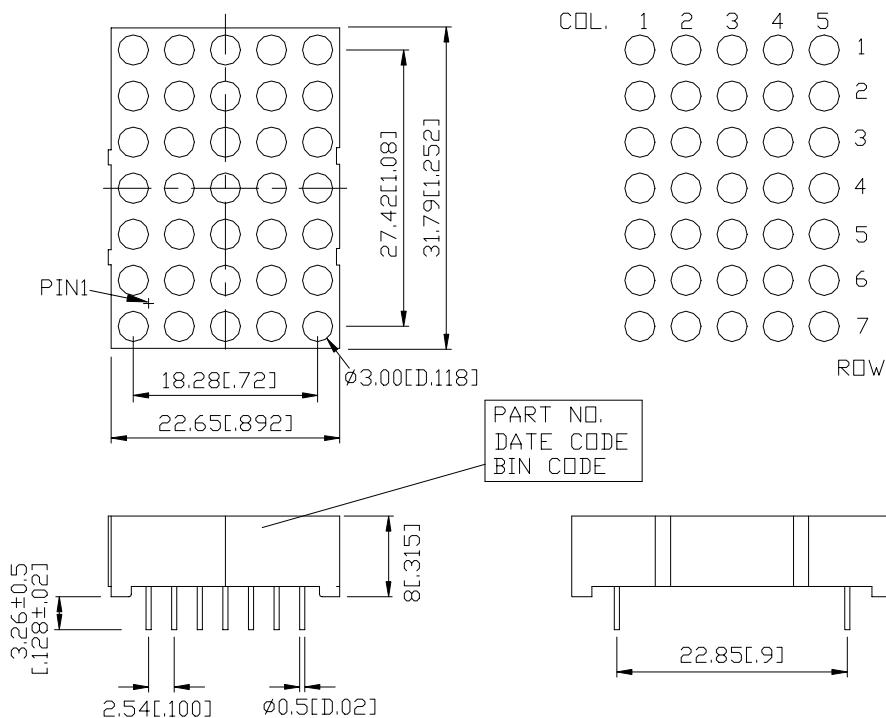

NOTES: All dimensions are in millimeters. Tolerance is ± 0.25 mm (0.01") unless otherwise noted.

INTERNAL CIRCUIT DIAGRAM

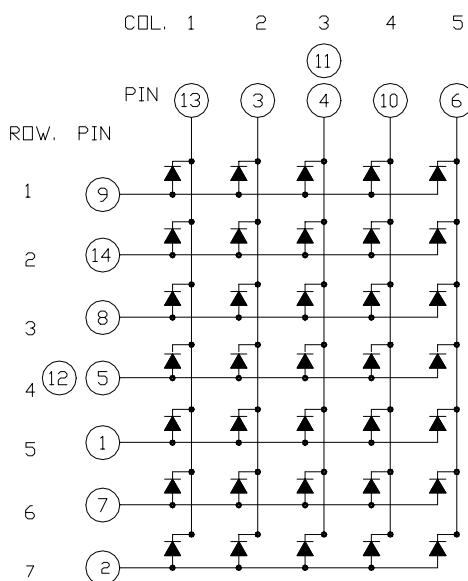

PIN CONNECTION

No.	CONNECTION
1	ANODE ROW 5
2	ANODE ROW 7
3	CATHODE COLUMN 2
4	CATHODE COLUMN 3*1
5	ANODE ROW 4*2
6	CATHODE COLUMN 5
7	ANODE ROW 6
8	ANODE ROW 3
9	ANODE ROW 1
10	CATHODE COLUMN 4
11	CATHODE COLUMN 3*1
12	ANODE ROW 4*2
13	CATHODE COLUMN 1
14	ANODE ROW 2

NOTES : 1.Pin 4 & 11 are internally connected.
2.Pin 5 & 12 are internally connected.

ABSOLUTE MAXIMUM RATING AT Ta=25°C

PARAMETER	MAXIMUM RATING	UNIT
Average Power Dissipation Per Dot	36	mW
Peak Forward Current Per Dot	100	mA
Average Forward Current Per Dot	13	mA
Derating Linear From 25°C Per Dot	0.17	mA/°C
Reverse Voltage Per Dot	5	V
Operating Temperature Range	-35°C to +85°C	
Storage Temperature Range	-35°C to +85°C	
Solder Temperature: max 260°C for max 3sec at 1.6mm[1/16inch] below seating plane.		

ELECTRICAL / OPTICAL CHARACTERISTICS AT Ta=25°C

PARAMETER	SYMBOL	MIN.	TYP.	MAX.	UNIT	TEST CONDITION
Average Luminous Intensity	I _v	1780	4000		μcd	I _p =80mA 1/16Duty
Peak Emission Wavelength	λ _p		565		nm	I _F =20mA
Spectral Line Half-Width	Δλ		30		nm	I _F =20mA
Dominant Wavelength	λ _d		569		nm	I _F =20mA
Forward Voltage any Dot	V _F		2.1	2.6	V	I _F =20mA
			3.0	3.7		I _F =80mA
Reverse Current any Dot	I _R			100	μA	V _R =5V
Luminous Intensity Matching Ratio	I _v -m			2:1		I _F =10mA

Note: Luminous intensity is measured with a light sensor and filter combination that approximates the CIE (Commision Internationale De L'Eclairage) eye-response curve.

* Binning Condition:

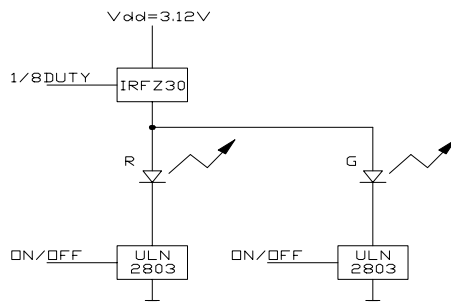

TYPICAL ELECTRICAL / OPTICAL CHARACTERISTIC CURVES

(25°C Ambient Temperature Unless Otherwise Noted)

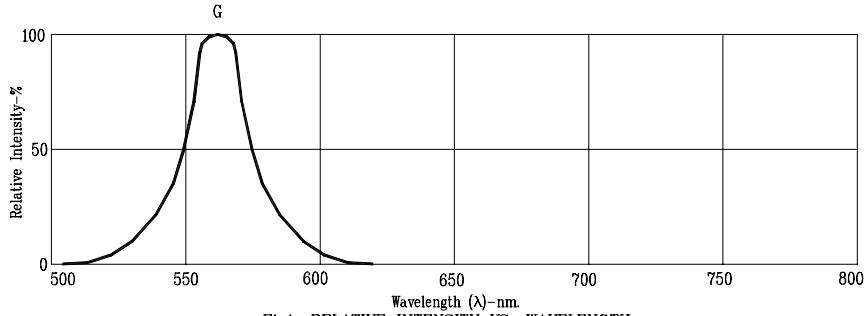

Fig1. RELATIVE INTENSITY VS. WAVELENGTH

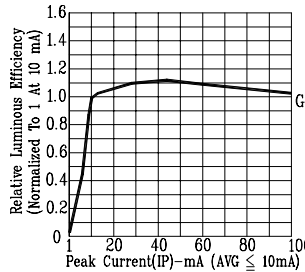

Fig2. RELATIVE LUMINOUS EFFICIENCY (LUMINOUS INTENSITY PER UNIT CURRENT) VS. PEAK CURRENT (REFRESH RATE 1KHz)

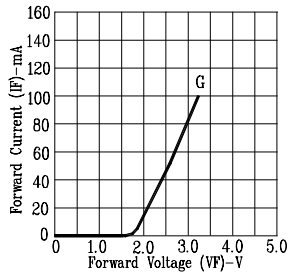

Fig3. FORWARD CURRENT VS. FORWARD VOLTAGE

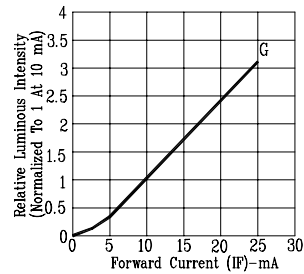

Fig4. RELATIVE LUMINOUS INTENSITY VS. FORWARD CURRENT

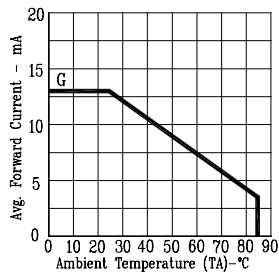

Fig5. MAX AVERAGE FORWARD CURRENT VS. AMBIENT TEMPERATURE.

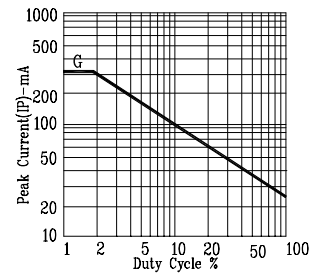

Fig6. MAX. PEAK CURRENT VS. DUTY CYCLE % (REFRESH RATE 1KHz)

NOTE: G=GREEN