

Features

- Integrated Logic
- Positive Single Control
- Insertion Loss: 1 dB @ 1.0 GHz
- IP3: 42 dBm typical @ 2.0 GHz
- Attenuation Accuracy: 0.2 dB + 2% @ 1.0 GHz
- 1-dB Attenuation Steps to 15 dB
- Low DC Power Consumption
- Lead-Free 3mm PQFN-16LD Plastic Package
- Halogen-Free "Green" Mold Compound
- RoHS* Compliant and 260°C Re-flow Compatible

Description

The MAADSS0013 is a 4-bit, 1-dB step GaAs MMIC digital attenuator in a lead-free 3mm PQFN-16LD surface mount plastic package. The MAADSS0013 is ideally suited for use where high accuracy, very low power consumption and low intermodulation products are required. Typical applications include radio, cellular, wireless LANs, GPS equipment and other gain / level control circuits.

The MAADSS0013 is part of a digital attenuator family. This family includes 4, 5, and 6 bit attenuators with 0.5, 1, or 2 dB steps and up to 31.5 range.

Ordering Information ^{1,2}

Part Number	Package
MAADSS0013TR-1000	1000 piece reel
MAADSS0013TR-3000	3000 piece reel
MAADSS0013SMB	Sample Board

1. Reference Application Note M513 for reel size information.
2. All sample boards include 5 loose parts.

Functional Schematic ³

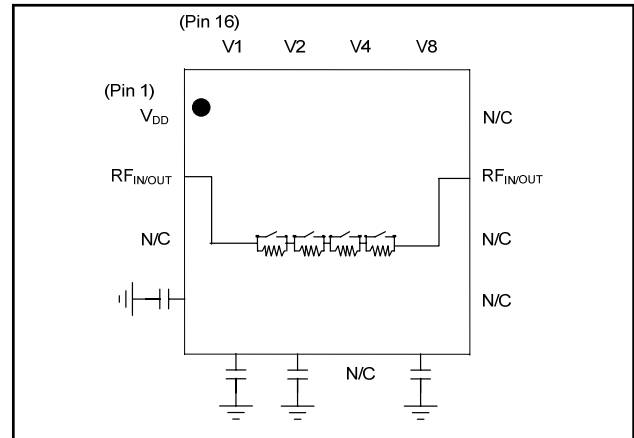

3. Blocking capacitors are required on all RF ports.

Pin Configuration

Pin No.	Function	Pin No.	Function
1	V _{DD}	9	N/C or GND
2	RF In/Out	10	N/C or GND
3	N/C or GND	11	RF In/Out
4	Ext. C to GND	12	N/C or GND
5	Ext. C to GND	13	V8 (8 dB Bit)
6	Ext. C to GND	14	V4 (4 dB Bit)
7	N/C or GND	15	V2 (2 dB Bit)
8	Ext. C to GND	16	V1 (1 dB Bit)
		17	Paddle ⁴

4. The exposed paddle centered on the package bottom should be grounded.

Absolute Maximum Ratings ^{5,6}

Parameter	Absolute Maximum
Input Power 0.5 - 4.0 GHz	+33 dBm
Control Voltage	-0.5 V ≤ V _C ≤ 5.5 V
Operating Temperature	-40°C to +85°C
Storage Temperature	-65°C to +150°C

5. Exceeding any one or combination of these limits may cause permanent damage to this device.
6. M/A-COM Technology does not recommend sustained operation near these survivability limits.

* Restrictions on Hazardous Substances, European Union Directive 2002/95/EC.

ADVANCED: Data Sheets contain information regarding a product M/A-COM Technology Solutions is considering for development. Performance is based on target specifications, simulated results, and/or prototype measurements. Commitment to develop is not guaranteed.
PRELIMINARY: Data Sheets contain information regarding a product M/A-COM Technology Solutions has under development. Performance is based on engineering tests. Specifications are typical. Mechanical outline has been fixed. Engineering samples and/or test data may be available. Commitment to produce in volume is not guaranteed.

• **North America** Tel: 800.366.2266 • **Europe** Tel: +353.21.244.6400
 • **India** Tel: +91.80.43537383 • **China** Tel: +86.21.2407.1588
 Visit www.macomtech.com for additional data sheets and product information.

M/A-COM Technology Solutions Inc. and its affiliates reserve the right to make changes to the product(s) or information contained herein without notice.

Digital Attenuator, 4-Bit, Single Control 15 dB, 0.05 - 4.0 GHz

Rev. V2

Electrical Specifications ^{7,8}: $T_A = 25^\circ\text{C}$, $Z_0 = 50 \Omega$, $V_{DD} = 5 \text{ V}$, $V_C = 2.8 \text{ V}$

Parameter	Test Conditions	Units	Min.	Typ.	Max.
Reference Insertion Loss	1.0 GHz	dB	—	1.0	1.3
Attenuation Accuracy	1.0 GHz	± (0.2 dB + 2% of attenuation setting in dB) dB			
VSWR	0.05 - 4.0 GHz	Ratio	—	1.5:1	—
Trise, Tfall	10% to 90% RF, 90% to 10% RF	ns	—	40	—
Ton, Toff	50% Control to 90% RF, 50% Control to 10% RF	ns	—	65	—
Transients	In Band	mV	—	75	—
Input P1dB	2.0 GHz	dBm	—	30	—
Input IP ₂	2-Tone, +5 dBm/tone, 1 MHz Spacing 0.5 GHz 2.0 GHz	dBm	— —	75 80	— —
Input IP ₃	2-Tone, +5 dBm/tone, 1 MHz Spacing 0.5, 2.0 GHz	dBm	—	42	—
I _C	V _C = 2.8 V	μA	—	15	25
I _{DD}	V _{DD} = 5 V	μA	—	170	250

7. External DC blocking capacitors are required on all RF ports.

8. Low frequency performance is determined by DC block and GND capacitor value.

Truth Table ⁹

VC1	VC2	VC4	VC8	Attenuation (dB)
0	0	0	0	Reference IL
1	0	0	0	1
0	1	0	0	2
0	0	1	0	4
0	0	0	1	8
1	1	1	1	15

9. 0 = 0 V, 1 = +2.8 to 5 V.

Handling Procedures

Please observe the following precautions to avoid damage:

Static Sensitivity

Gallium Arsenide Integrated Circuits are sensitive to electrostatic discharge (ESD) and can be damaged by static electricity. Proper ESD control techniques should be used when handling these devices.

Typical Performance Curves

Insertion Loss

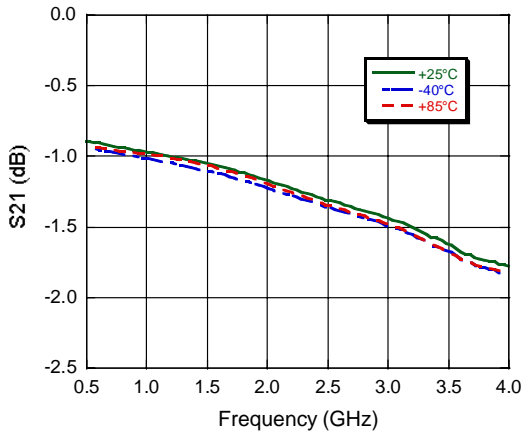

Relative Attenuation across all major states

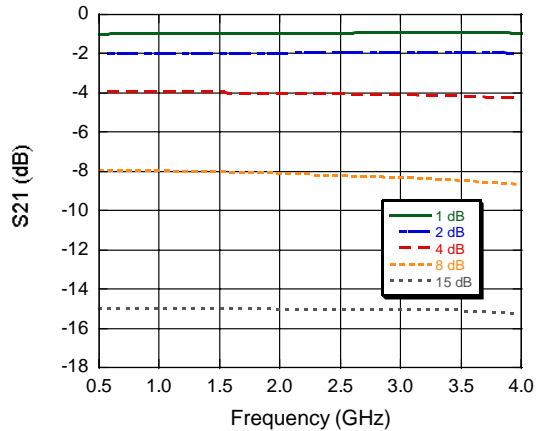

Input Return Loss, Insertion Loss State

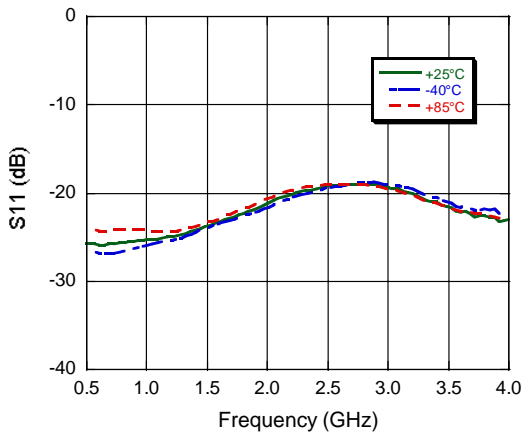

Input Return Loss, across all major attenuation states

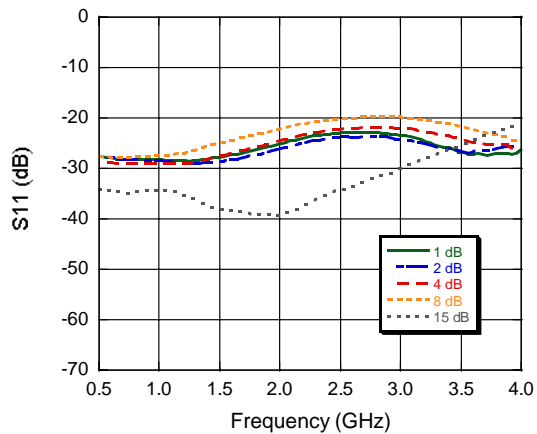

Output Return Loss, Insertion Loss State

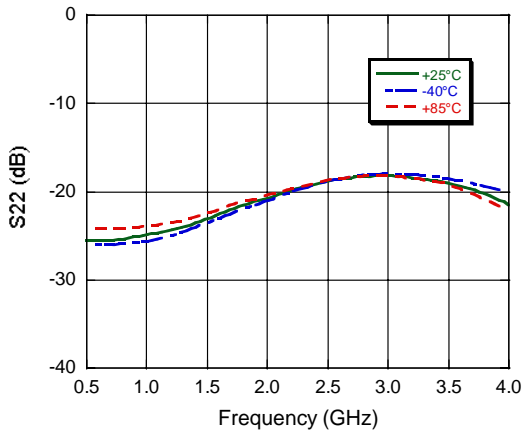

Output Return Loss, across all major attenuation states

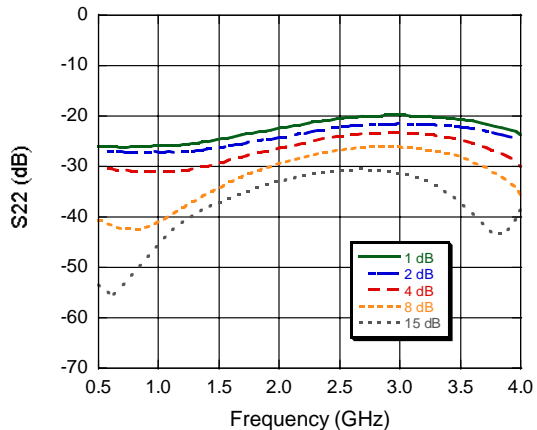

Typical Performance Curves

Input IP3 @ 0.5 GHz

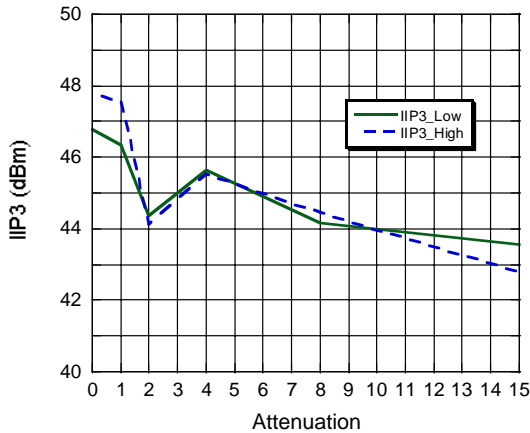

Input IP3 @ 2 GHz

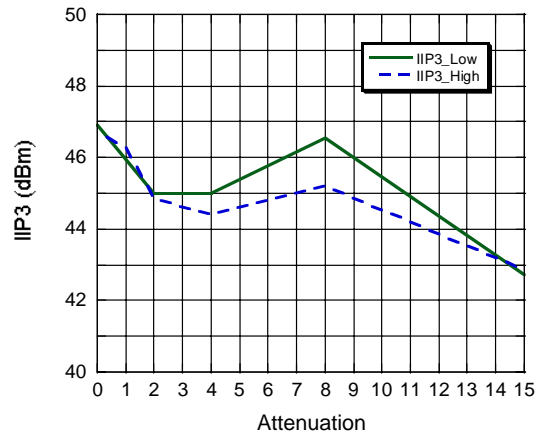

Lead Free 3 mm 16-Lead PQFN †

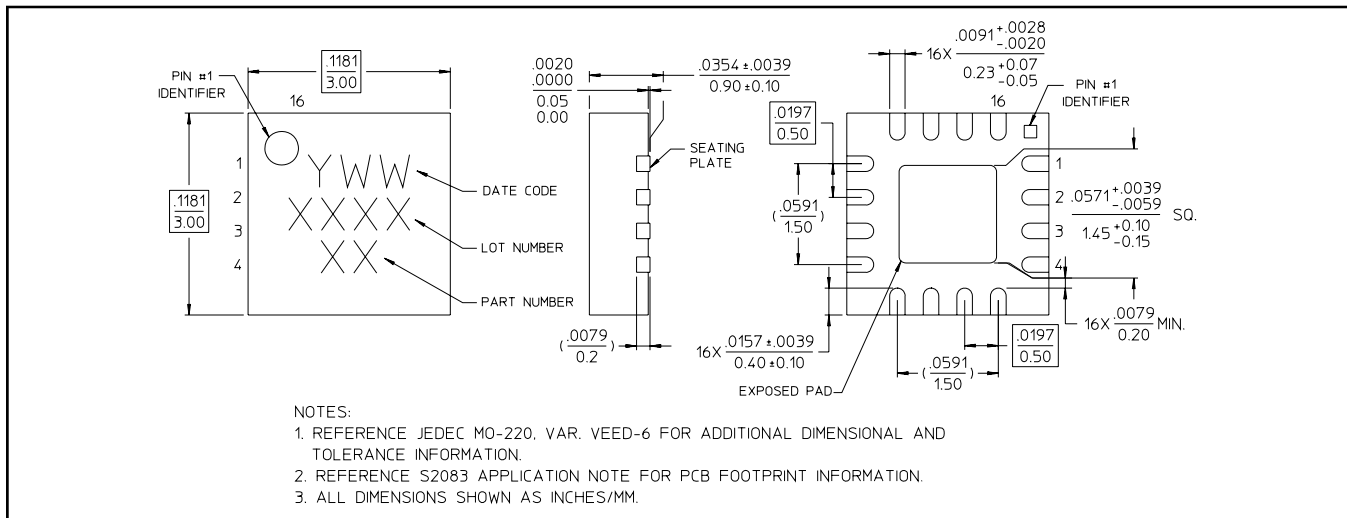

† Reference Application Note S2083 for lead-free solder reflow recommendations.
Meets JEDEC moisture sensitivity level 1 requirements.
Plating is 100% matte tin over copper.