

P-Channel Enhancement Mode Field Effect Transistor

FEATURES

- -30V, -3.8A, $R_{DS(ON)} = 55m\Omega$ @ $V_{GS} = -10V$.
 $R_{DS(ON)} = 86m\Omega$ @ $V_{GS} = -4.5V$.
- High dense cell design for extremely low $R_{DS(ON)}$.
- Rugged and reliable.
- Lead free product is acquired.
- SOT-23 package.

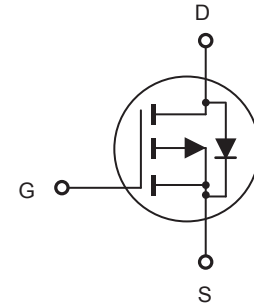
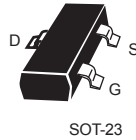

ABSOLUTE MAXIMUM RATINGS $T_A = 25^\circ\text{C}$ unless otherwise noted

| Parameter | Symbol | Limit | Units |
|---------------------------------------|----------------|------------|------------------|
| Drain-Source Voltage | V_{DS} | -30 | V |
| Gate-Source Voltage | V_{GS} | ± 20 | V |
| Drain Current-Continuous | I_D | -3.8 | A |
| Drain Current-Pulsed ^a | I_{DM} | -15.2 | A |
| Maximum Power Dissipation | P_D | 1.25 | W |
| Operating and Store Temperature Range | T_J, T_{stg} | -55 to 150 | $^\circ\text{C}$ |

Thermal Characteristics

| Parameter | Symbol | Limit | Units |
|--|-----------------|-------|--------------------|
| Thermal Resistance, Junction-to-Ambient ^b | $R_{\theta JA}$ | 100 | $^\circ\text{C/W}$ |



CES2313A

Electrical Characteristics $T_A = 25^\circ\text{C}$ unless otherwise noted

| Parameter | Symbol | Test Condition | Min | Typ | Max | Units |
|---|--------------|--|-----|-----|------|-----------|
| Off Characteristics | | | | | | |
| Drain-Source Breakdown Voltage | BV_{DSS} | $V_{GS} = 0V, I_D = -250\mu A$ | -30 | | | V |
| Zero Gate Voltage Drain Current | I_{DSS} | $V_{DS} = -30V, V_{GS} = 0V$ | | | -1 | μA |
| Gate Body Leakage Current, Forward | I_{GSSF} | $V_{GS} = 20V, V_{DS} = 0V$ | | | 100 | nA |
| Gate Body Leakage Current, Reverse | I_{GSSR} | $V_{GS} = -20V, V_{DS} = 0V$ | | | -100 | nA |
| On Characteristics ^c | | | | | | |
| Gate Threshold Voltage | $V_{GS(th)}$ | $V_{GS} = V_{DS}, I_D = -250\mu A$ | -1 | | -3 | V |
| Static Drain-Source On-Resistance | $R_{DS(on)}$ | $V_{GS} = -10V, I_D = -3.8A$ | | 45 | 55 | $m\Omega$ |
| | | $V_{GS} = -4.5V, I_D = -3A$ | | 66 | 86 | $m\Omega$ |
| Dynamic Characteristics ^d | | | | | | |
| Forward Transconductance | g_{FS} | $V_{DS} = -15V, I_D = -3.8A$ | | 4 | | S |
| Input Capacitance | C_{iss} | $V_{DS} = -15V, V_{GS} = 0V, f = 1.0\text{ MHz}$ | | 640 | | pF |
| Output Capacitance | C_{oss} | | | 135 | | pF |
| Reverse Transfer Capacitance | C_{rss} | | | 95 | | pF |
| Switching Characteristics ^d | | | | | | |
| Turn-On Delay Time | $t_{d(on)}$ | $V_{DD} = -15V, I_D = -1A, V_{GS} = -10V, R_{GEN} = 6\Omega$ | | 11 | 20 | ns |
| Turn-On Rise Time | t_r | | | 5 | 10 | ns |
| Turn-Off Delay Time | $t_{d(off)}$ | | | 30 | 60 | ns |
| Turn-Off Fall Time | t_f | | | 7 | 14 | ns |
| Total Gate Charge | Q_g | $V_{DS} = -15V, I_D = -3.8A, V_{GS} = -10V$ | | 13 | 17 | nC |
| Gate-Source Charge | Q_{gs} | | | 2 | | nC |
| Gate-Drain Charge | Q_{gd} | | | 3 | | nC |
| Drain-Source Diode Characteristics and Maximum Ratings | | | | | | |
| Drain-Source Diode Forward Current ^b | I_S | | | | -3.8 | A |
| Drain-Source Diode Forward Voltage ^c | V_{SD} | $V_{GS} = 0V, I_S = -3.8A$ | | | -1.3 | V |
| Notes : □ a.Repetitive Rating : Pulse width limited by maximum junction temperature.□ b.Surface Mounted on FR4 Board, $t < 5\text{ sec.}$ □ c.Pulse Test : Pulse Width $\leq 300\mu s$, Duty Cycle $\leq 2\%$.□ d.Guaranteed by design, not subject to production testing.□ □ | | | | | | |



CES2313A

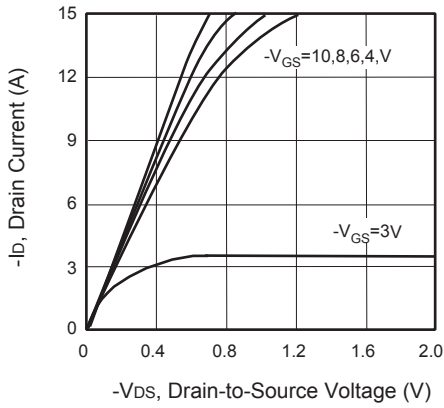

Figure 1. Output Characteristics

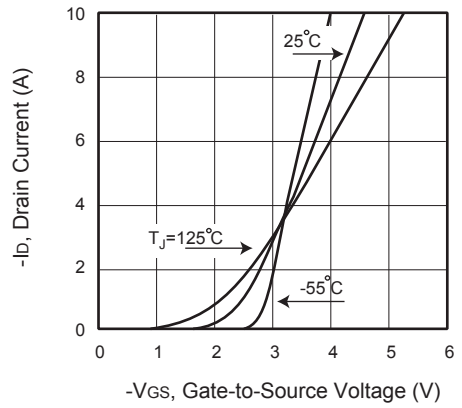

Figure 2. Transfer Characteristics

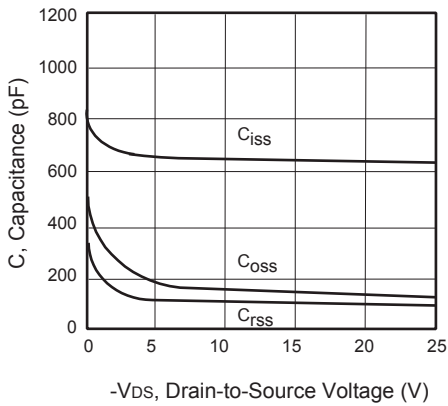

Figure 3. Capacitance

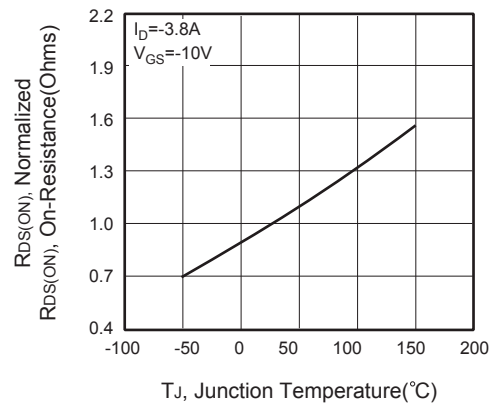

Figure 4. On-Resistance Variation with Temperature

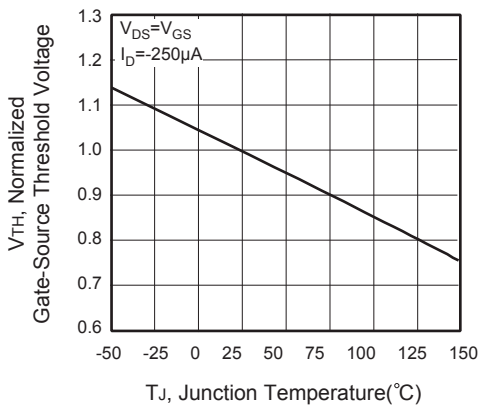

Figure 5. Gate Threshold Variation with Temperature

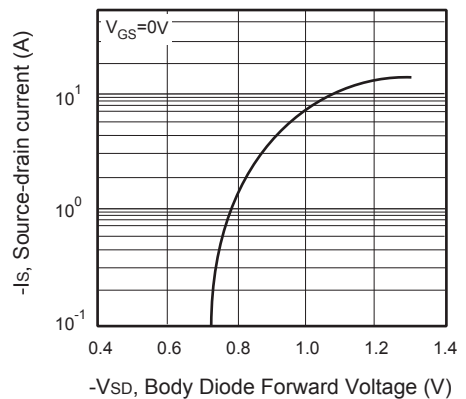

Figure 6. Body Diode Forward Voltage Variation with Source Current



CES2313A

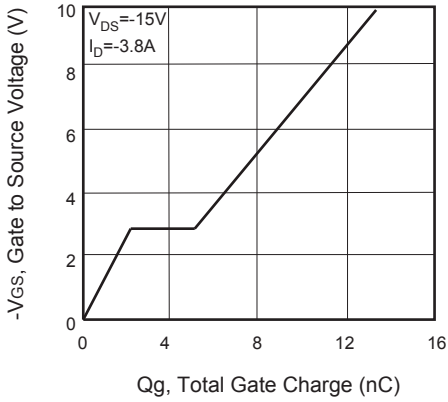

Figure 7. Gate Charge

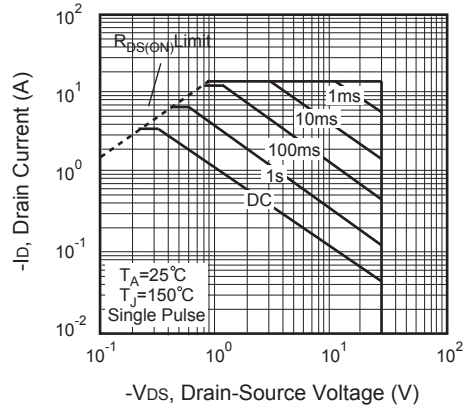

Figure 8. Maximum Safe Operating Area

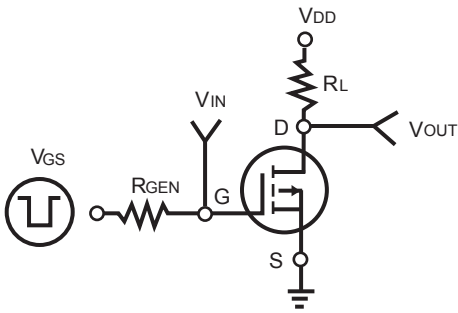

Figure 9. Switching Test Circuit



Figure 10. Switching Waveforms

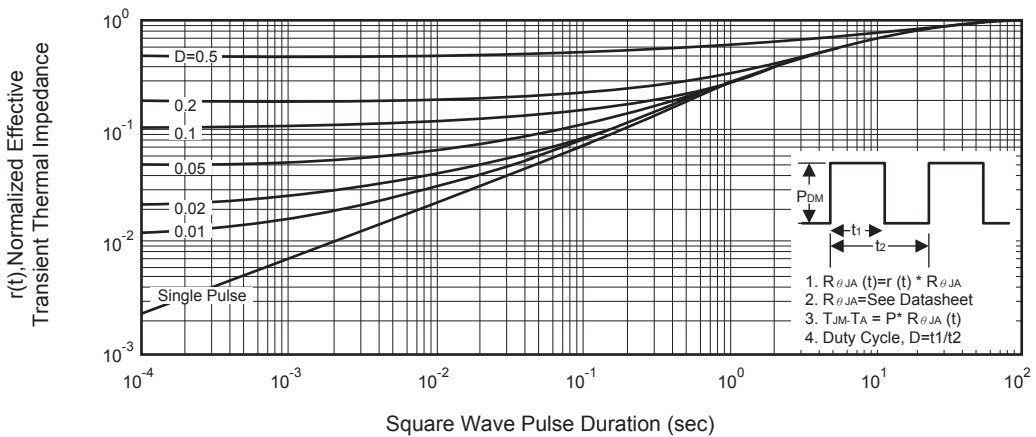

Figure 11. Normalized Thermal Transient Impedance Curve