

Power Inductor CDEP1411



 **sumida**



■ Features

- ◎ Magnetically shielded construction.
- ◎ Storage temperature range: $-40^{\circ}\text{C}\sim+125^{\circ}\text{C}$.
- ◎ Operating temperature range: $-40^{\circ}\text{C}\sim+125^{\circ}\text{C}$
(including coil's self temperature rise).
- ◎ RoHS Compliance and Halogen Free.

■ Applications

Ideally used in PC and Game machine power supply.

■ Dimensions/Recommended Land Patterns (mm)

◆ Dimensions

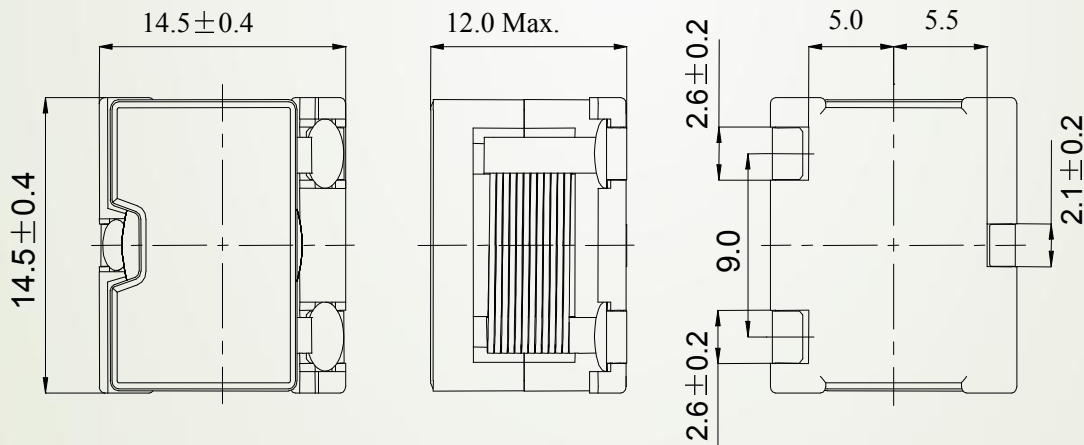

◆ Land pattern

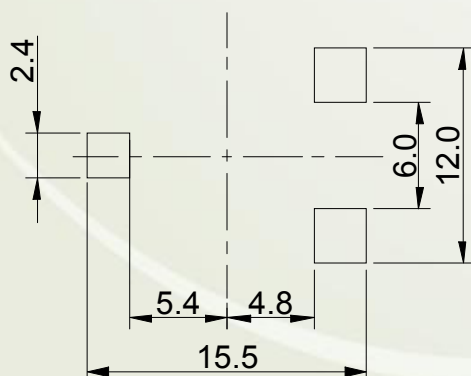

Power Inductor CDEP1411



■ Electrical Characteristics specification.

Electrical characteristics-1

NO	Part name	Stamp	Inductance (μH) [Within] ※1	D.C.R. ($\text{m}\Omega$)[Max.] (at 20°C) ※2	saturation current (A) ※3		Temperature rise current (A) ※4
					(at20°C)	(at105°C)	
01	CDEP1411NP-7R4MC-150	7R4MH	7.4±20%	4.44(3.7)	10.8	8.4	13.0
02	CDEP1411NP-100MC-150	100MH	10±20%	5.40(4.5)	9.2	6.9	12.5
03	CDEP1411NP-120MC-150	120MH	12±20%	7.56(6.3)	8.5	6.5	10.3
04	CDEP1411NP-150MC-150	150MH	15±20%	8.40(7.0)	8.0	6.0	9.6
05	CDEP1411NP-180MC-150	180MH	18±20%	9.72(8.1)	7.2	5.5	9.0
06	CDEP1411NP-220MC-150	220MH	22±20%	11.28(9.4)	6.4	5.0	8.3

Electrical characteristics-2

NO	Part name	Stamp	Inductance (μH) [Within] ※1	D.C.R. ($\text{m}\Omega$)[Max.] (at 20°C) ※2	saturation current (A) ※3		Temperature rise current (A) ※4
					(at20°C)	(at105°C)	
07	CDEP1411NP-4R7MC-95	4R7ML	4.7±20%	4.44(3.7)	18.4	14.0	13.0
08	CDEP1411NP-6R1MC-95	6R1ML	6.1±20%	5.40(4.5)	16.4	12.4	12.5
09	CDEP1411NP-7R7MC-95	7R7ML	7.7±20%	7.56(6.3)	14.8	11.2	10.3
10	CDEP1411NP-100MC-95	100ML	10±20%	8.40(7.0)	13.1	10.0	9.6
11	CDEP1411NP-120MC-95	120ML	12±20%	9.72(8.1)	11.8	9.0	9.0
12	CDEP1411NP-140MC-95	140ML	14±20%	11.28(9.4)	10.9	8.3	8.3

※1 Measuring frequency inductance at 100kHz .

※2 () are typical value.

※3 Saturation current: The DC current at which the inductance decreases to 75% of its nominal value.

※4 Temperature rise current: The DC current at which the temperature rise is $\Delta t=40^{\circ}\text{C}$. ($T_a=20^{\circ}\text{C}$)

Power Inductor CDEP1411



Rated Current Curve

Saturation current and Temperature rise

Part No. : CDEP1411NP-7R4MC-150

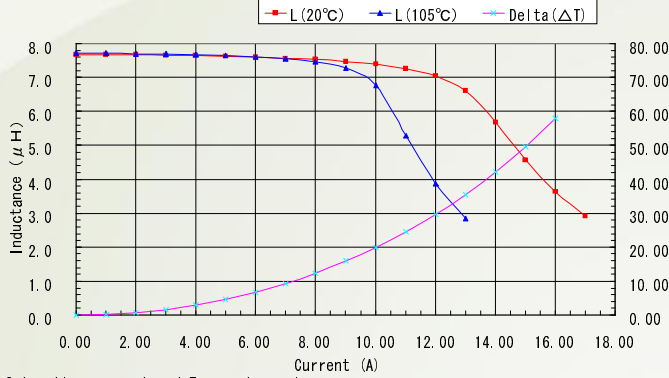

Saturation current and Temperature rise

Part No. : CDEP1411NP-100MC-150

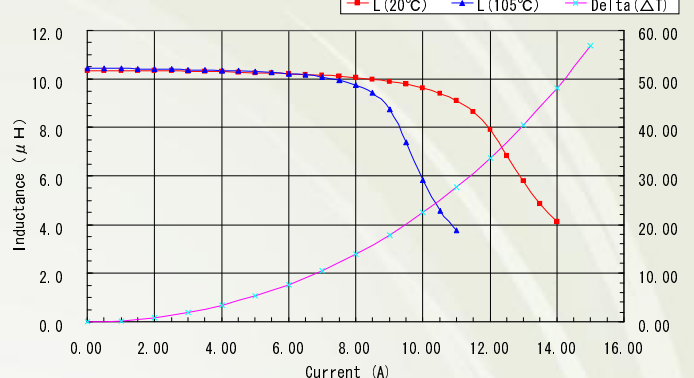

Saturation current and Temperature rise

Part No. : CDEP1411NP-120MC-150

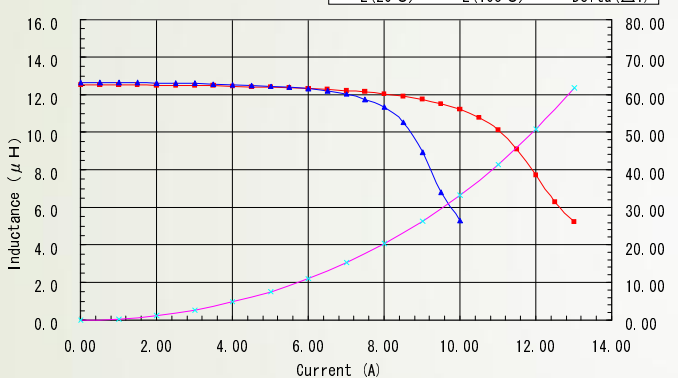

Saturation current and Temperature rise

Part No. : CDEP1411NP-150MC-150

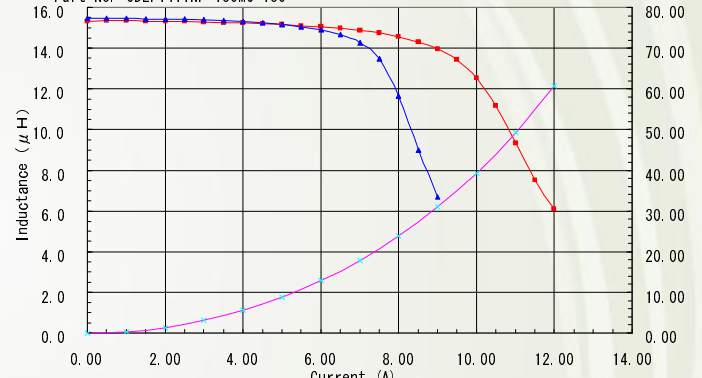

Saturation current and Temperature rise

Part No. : CDEP1411NP-180MC-150

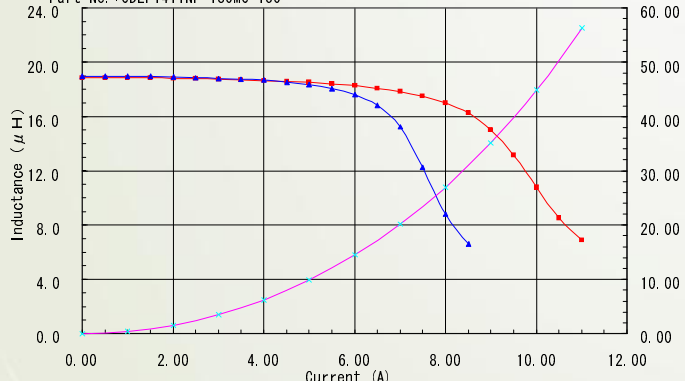

Saturation current and Temperature rise

Part No. : CDEP1411NP-220MC-150

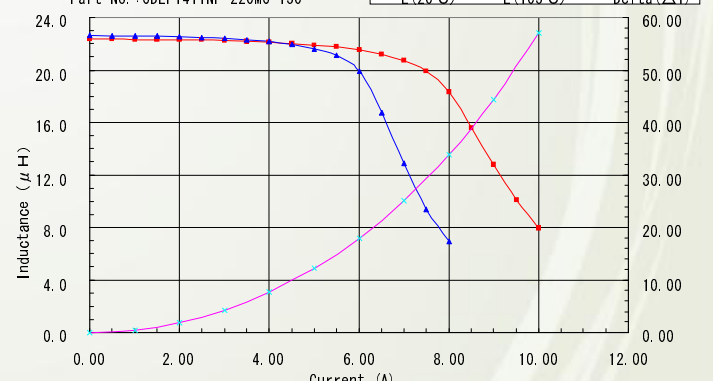

Saturation current and Temperature rise

Part No. : CDEP1411NP-4R7MC-95

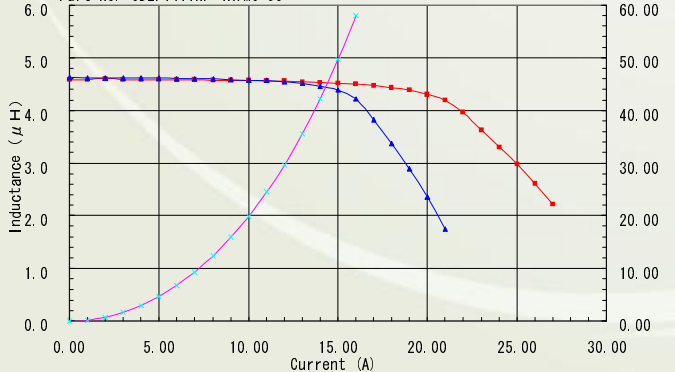

Saturation current and Temperature rise

Part No. : CDEP1411NP-6R1MC-95

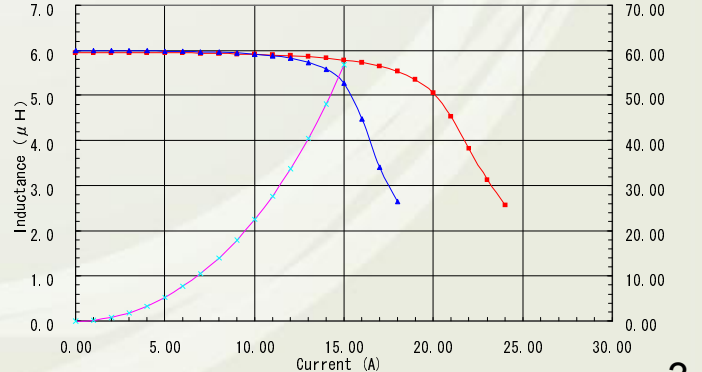

Power Inductor CDEP1411

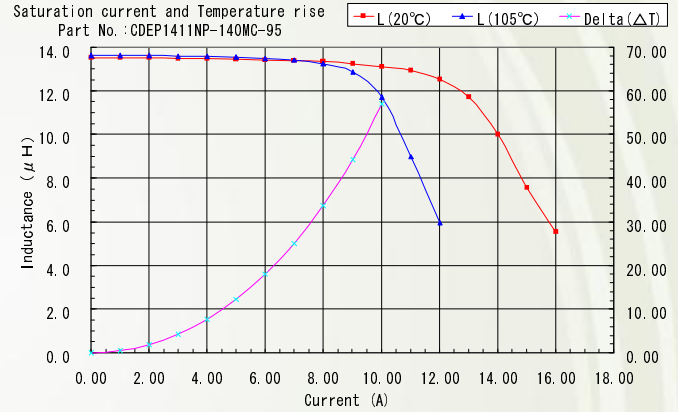
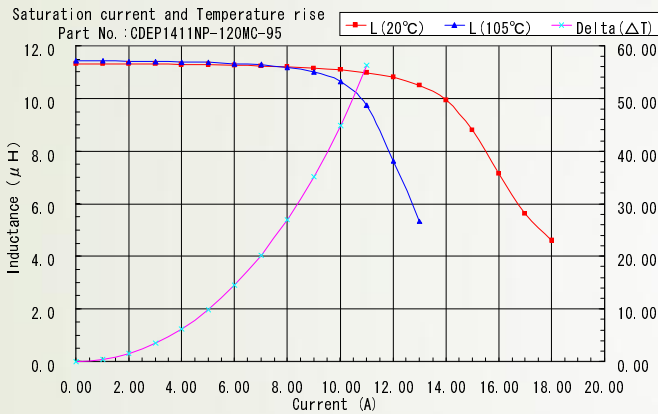
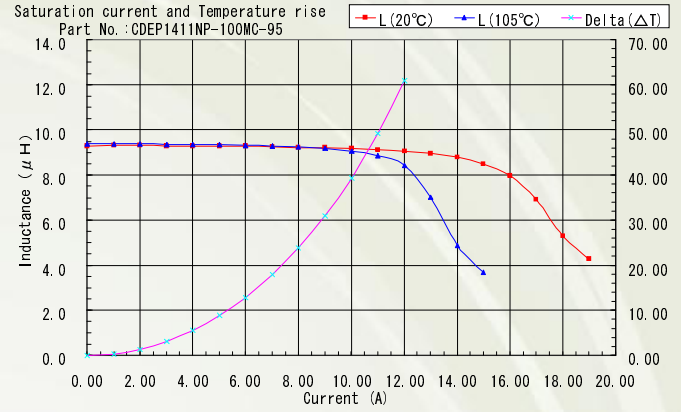
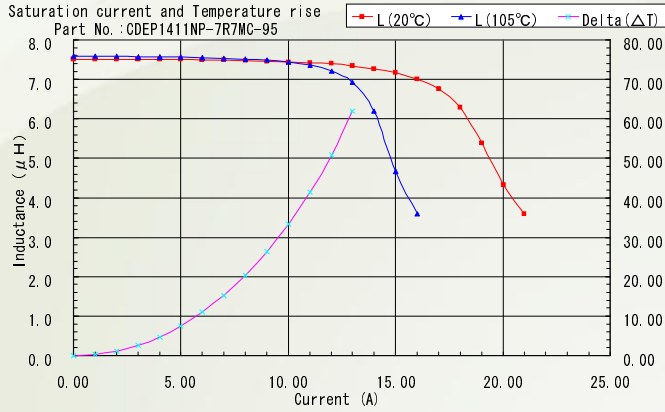

For More Information

Hong Kong

Tel.+852-2880-6688
FAX.+852-2565-9600

Tokyo

Tel.+81-3-5202-7112
FAX.+81-3-5202-7105

Chicago

Tel.+1-847-545-6700
FAX. +1-847-545-6720

Shanghai

Tel.+86-021-5836-3299
FAX.+86-021-5836-3266

Seoul

Tel.+82-2-6237-0777
FAX.+82-2-6237-0778

Obernzell

Tel.+49-8591-937-0
FAX. +49-8591-937-103

Shenzhen

Tel.+86-755-8291-0228
FAX.+86-755-8291-0338

Singapore

Tel.+65-6296-3388
FAX.+65-6296-3390

Neumarkt

Tel.+49-9181-4509-110
FAX. +49-9181-4509-310

Taipei

Tel.+886-2-8751-2737
FAX.+886-2-8751-2738

San Jose

Tel.+1-408-321-9660
FAX.+1-408-321-9308