

PLEASE CHECK WWW.MOLEX.COM FOR LATEST PART INFORMATION

Part Number: [0039294209](#)
Status: **Active**
Overview: [minifit_jr](#)
Description: 4.20mm (.165") Pitch Mini-Fit Jr.™ Header, Dual Row, Right Angle, with PCB Mounting Flange, 20 Circuits, PA Polyamide Nylon 6/6 94V-0, Gold (Au) Plating

Documents:

[3D Model](#) [RoHS Certificate of Compliance \(PDF\)](#)
[Drawing \(PDF\)](#)

Agency Certification

CSA	LR19980
TUV	R72081037
UL	E29179

General

Product Family	PCB Headers
Series	5569
Application	Wire-to-Board
Comments	Current = 13A max. per circuit when header is mated to a receptacle loaded with 45750 Mini-Fit Plus HCS™ Crimp Terminal Crimped to to 16 AWG wire. . See Molex product specification PS-45750-001 for additional current de-rating information.

Overview	minifit_jr
Product Name	Mini-Fit Jr.™

Physical

Breakaway	No
Circuits (Loaded)	20
Circuits (maximum)	20
Circuits Detail	20
Color - Resin	Natural
Durability (mating cycles max)	30
First Mate / Last Break	No
Flammability	94V-0
Glow-Wire Compliant	No
Guide to Mating Part	No
Keying to Mating Part	None
Lock to Mating Part	Yes
Material - Metal	Brass
Material - Plating Mating	Gold
Material - Plating Termination	Gold
Material - Resin	Nylon
Number of Rows	2
Orientation	Right Angle
PCB Locator	Yes
PCB Retention	Yes
PCB Thickness Recommended (in)	0.070 In
PCB Thickness Recommended (mm)	1.78 mm
Packaging Type	Bag
Pitch - Mating Interface (in)	0.165 In
Pitch - Mating Interface (mm)	4.20 mm
Pitch - Term. Interface (in)	0.165 In
Pitch - Term. Interface (mm)	4.20 mm
Polarized to Mating Part	Yes

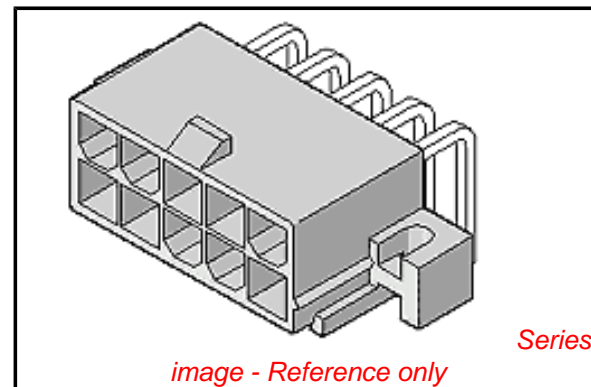

EU RoHS

ELV and RoHS Compliant
REACH SVHC
 Not Reviewed
Halogen-Free Status
Not Reviewed

China RoHS



Need more information on product environmental compliance?

Email productcompliance@molex.com
 For a multiple part number RoHS Certificate of Compliance, [click here](#)

Please visit the [Contact Us](#) section for any non-product compliance questions.

Search Parts in this Series

[5569Series](#)

Mates With

[5557](#) Mini-Fit Jr.™ Receptacle Housing

Polarized to PCB	Yes
Shrouded	Fully
Stackable	No
Surface Mount Compatible (SMC)	No
Temperature Range - Operating	-40°C to +105°C
Termination Interface: Style	Through Hole

Electrical

Current - Maximum per Contact	13A
Voltage - Maximum	600V

Material Info

Old Part Number	A556920AG1210
-----------------	---------------

Reference - Drawing Numbers

Packaging Specification	PK-5569-NA*
Sales Drawing	SD-5569-002

This document was generated on 05/21/2010

PLEASE CHECK WWW.MOLEX.COM FOR LATEST PART INFORMATION

注記

1. 嵌合相手: 5557 シリーズ
MATES WITH: 5557 SERIES
2. 2極の場合のみ本寸法は 4.2
IN CASE OF 2 CIRCUITS HEADER, THIS DIMENSION SHOULD BE 4.2mm.
3. 材料及びメッキ
MATERIAL & FINISH

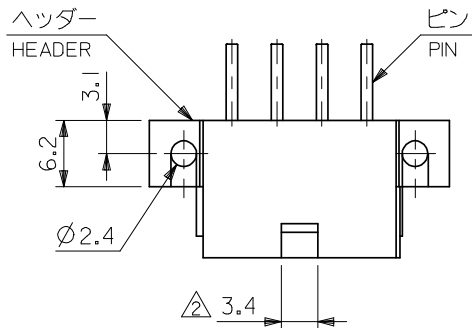

ENG. NO.	ヘッダー材料 HEADER MATERIAL	ピン材料 PIN MATERIAL	ピンのメッキ FINISH OF PIN
5569-NA1	ナイロン66, UL94V-2 NYLON 66, UL94V-2	黄銅 (□1.07)	銅下地錫メッキ TIN OVER COPPER
-NA1-210	ナイロン66, UL94V-0 NYLON 66, UL94V-0		
-NAG1	ナイロン66, UL94V-2 NYLON 66, UL94V-2	BRASS (1.07 SQUARE)	金 : 0.76μm MIN. GOLD 0.76μm MIN.
5569-NAG1-210	ナイロン66, UL94V-0 NYLON 66, UL94V-0		ニッケル下地 : 1.27μm MIN. OVER NICKEL 1.27μm MIN.

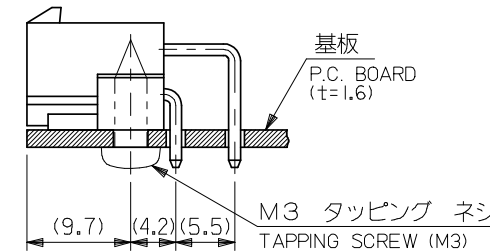
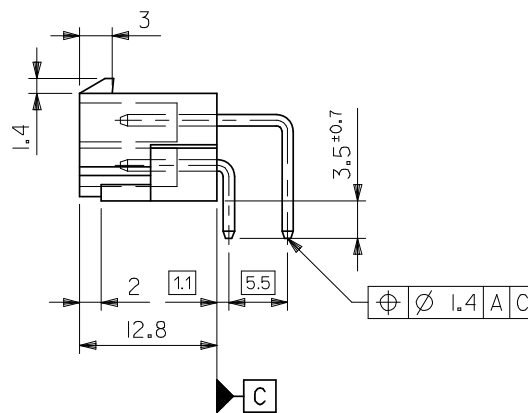
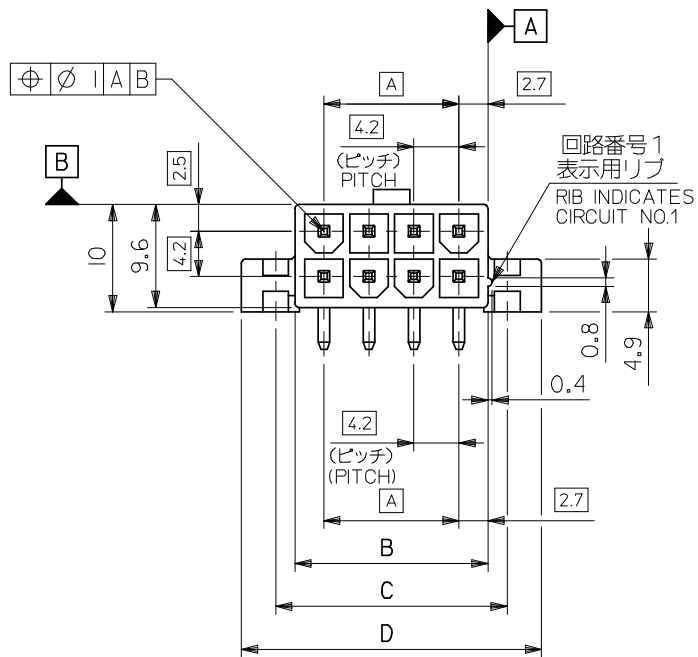

基板取付推奨寸法
RECOMMENDED INSTALLATION PATTERN

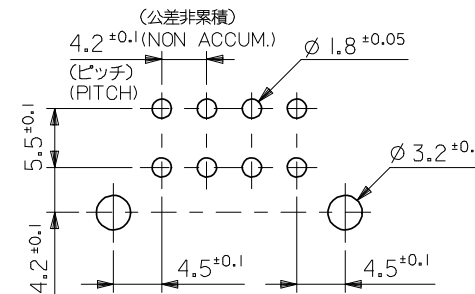

基板穴推奨寸法
RECOMMENDED P.C. BOARD PATTERN

61.6	55.2	51.6	46.2	24
57.4	51	47.4	42	22
53.2	46.8	43.2	37.8	20
49	42.6	39	33.6	18
44.8	38.4	34.8	29.4	16
40.6	34.2	30.6	25.2	14
36.4	30	26.4	21	12
32.2	25.8	22.2	16.8	10
28	21.6	18	12.6	8
23.8	17.4	13.8	8.4	6
19.6	13.2	9.6	4.2	4
15.4	9	5.4	—	2
D	C	B	A	極数 CIRCUIT

REVISED EC NO: J2008-3781 DRWN: NABEI 2008/05/12 CHKD: MISOGAYA 2008/05/12 APPR: NUKITA 2008/05/12	DESCRIPTION	GENERAL TOLERANCES (UNLESS SPECIFIED)		DIMENSION STYLE MM ONLY		SCALE 2:1	DESIGN UNITS METRIC	THIRD ANGLE PROJECTION	
		10 UNDER	±0.2	DRAWN BY H. HIRAMOTO	DATE '90/04/23	TITLE NEW MINI FIT CONN R/A HEADER ASSY WITH FLANGE			
10 OVER 30 UNDER	±0.3	CHECKED BY M. FUKUSHIMA	DATE '91/07/04	MATERIAL NO. SD-5569-002					
30 OVER	±0.4	APPROVED BY M. ENOMOTO	DATE '91/07/04	SHEET NO. 1 OF 2					
ANGULAR ±3°		DRAFT WHERE APPLICABLE MUST REMAIN WITHIN DIMENSIONS		SEE TABLE		MOLEX INCORPORATED			
THIS DRAWING CONTAINS INFORMATION THAT IS PROPRIETARY TO MOLEX INCORPORATED AND SHOULD NOT BE USED WITHOUT WRITTEN PERMISSION		SIZE A3		DOCUMENT NO. SD-5569-002					

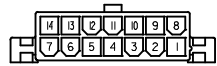

14極
14 CKTS.

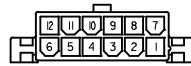

12極
12 CKTS.

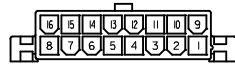

16極
16 CKTS.

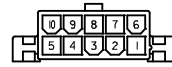

10極
10 CKTS.

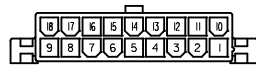

18極
18 CKTS.

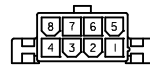

8極
8 CKTS.

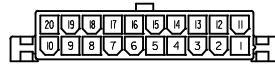

20極
20 CKTS.

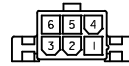

6極
6 CKTS.

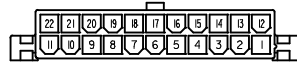

22極
22 CKTS.

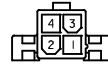

4極
4 CKTS.

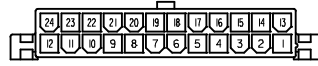

24極
24 CKTS.



2極
2 CKTS.

極数別レイアウト図
CIRCUIT SIZE LAYOUT
(SCALE 1:1)

39-29-4249	5569-24AG1-210	39-29-1247	5569-24A1-210	24
▲ -4229	▲ -22AG1-210	▲ -1227	▲ -22A1-210	22
-4209	-20AG1-210	-1207	-20A1-210	20
-4189	-18AG1-210	-1187	-18A1-210	18
-4169	-16AG1-210	-1167	-16A1-210	16
-4149	-14AG1-210	-1147	-14A1-210	14
-4129	-12AG1-210	-1127	-12A1-210	12
-4109	-10AG1-210	-1107	-10A1-210	10
-4089	-08AG1-210	-1087	-08A1-210	8
-4069	-06AG1-210	-1067	-06A1-210	6
▼ -4049	▼ -04AG1-210	▼ -1047	▼ -04A1-210	4
39-29-4029	5569-02AG1-210	39-29-1027	5569-02A1-210	2
EDP NO.	ENG. NO.	EDP NO.	ENG. NO.	極数
5569-NAG1-210		5569-NA1-210		CIRCUIT
39-29-5243	5569-24AG1	39-29-1248	5569-24A1	24
▲ -5223	▲ -22AG1	▲ -1228	▲ -22A1	22
-5203	-20AG1	-1208	-20A1	20
-5183	-18AG1	-1188	-18A1	18
-5163	-16AG1	-1168	-16A1	16
-5143	-14AG1	-1148	-14A1	14
-5123	-12AG1	-1128	-12A1	12
-5103	-10AG1	-1108	-10A1	10
-5083	-08AG1	-1088	-08A1	8
-5063	-06AG1	-1068	-06A1	6
▼ -5043	▼ -04AG1	▼ -1048	▼ -04A1	4
39-29-5023	5569-02AG1	39-29-1028	5569-02A1	2
EDP NO.	ENG. NO.	EDP NO.	ENG. NO.	極数
5569-NAG1		5569-NA1		CIRCUIT

REVISED EC NO.: J2008-3781 DRWN:MMABEI 2008/05/12 CHKD:MI SOGAYA 2008/05/12 APPR:NUKITA 2008/05/12	GENERAL TOLERANCES (UNLESS SPECIFIED)		DIMENSION STYLE MM ONLY		SCALE 2:1	DESIGN UNITS METRIC	THIRD ANGLE PROJECTION
	10 UNDER	±0.2	DRAWN BY H.HIRAMOTO	DATE '90/04/23	TITLE NEW MINI FIT CONN R/A HEADER ASSY WITH FLANGE		
	10 OVER 30 UNDER	±0.3	CHECKED BY M.FUKUSHIMA	DATE '91/07/04			
	30 OVER	±0.4	APPROVED BY M.ONOMOTO	DATE '91/07/04	MOLEX INCORPORATED DOCUMENT NO. SD-5569-002 SHEET NO. 2 OF 2		
ANGULAR ±3 °		MATERIAL NO. SEE TABLE					
DRAFT WHERE APPLICABLE MUST REMAIN WITHIN DIMENSIONS		THIS DRAWING CONTAINS INFORMATION THAT IS PROPRIETARY TO MOLEX INCORPORATED AND SHOULD NOT BE USED WITHOUT WRITTEN PERMISSION					