



HER501 THRU HER508

HIGH EFFICIENT SILICON RECTIFIER

Reverse Voltage - 50 to 1000 Volts Forward Current - 5.0 Ampere

FEATURES

- The plastic package carries Underwriters Laboratory Flammability Classification 94V-0
- Ultra fast switching for high efficiency
- Low reverse leakage
- High forward surge current capability
- High temperature soldering guaranteed:
250°C/10 seconds, 0.375" (9.5mm) lead length, 5 lbs. (2.3kg) tension

MECHANICAL DATA

Case: JEDEC DO-201AD molded plastic body
Terminals: Plated axial leads, solderable per MIL-STD-750, Method 2026
Polarity: Color band denotes cathode end
Mounting Position: Any
Weight: 0.04 ounce, 1.10 grams

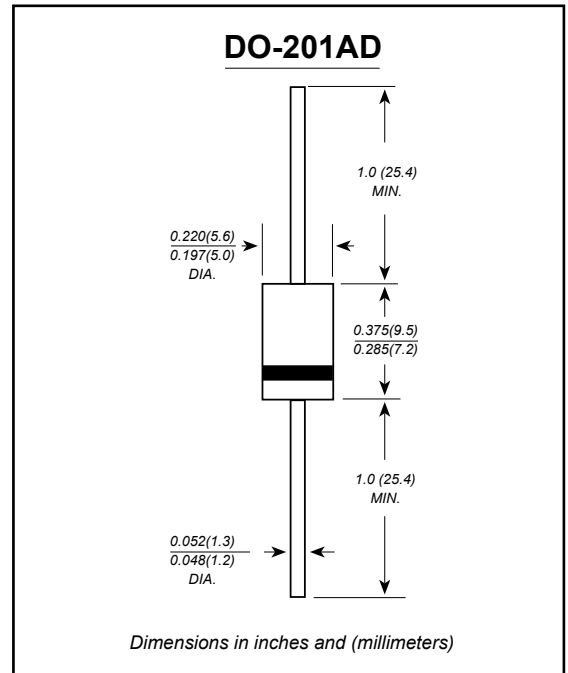

MAXIMUM RATINGS AND ELECTRICAL CHARACTERISTICS

Ratings at 25°C ambient temperature unless otherwise specified.
 Single phase half-wave 60Hz, resistive or inductive load, for capacitive load current derate by 20%.

Characteristic	Symbol	HER 501	HER 502	HER 503	HER 504	HER 505	HER 506	HER 507	HER 508	Unit	
Peak Repetitive Reverse Voltage	V _{RRM}	50	100	200	300	400	600	800	1000	V	
Working Peak Reverse Voltage	V _{RWM}										
DC Blocking Voltage	V _R										
RMS Reverse Voltage	V _{R(RMS)}	35	70	140	210	280	420	560	700	V	
Average Rectified Output Current (Note 1) @T _A = 55°C	I _O	5.0								A	
Non-Repetitive Peak Forward Surge Current 8.3ms Single half sine-wave superimposed on rated load (JEDEC Method)	I _{FSM}	150								A	
Forward Voltage @I _F = 5.0A	V _{FM}	1.0			1.3		1.7			V	
Peak Reverse Current @T _A = 25°C At Rated DC Blocking Voltage @T _A = 100°C	I _{RM}	10 100								µA	
Reverse Recovery Time (Note 2)	t _{rr}	50					75				nS
Typical Junction Capacitance (Note 3)	C _j	75					50				pF
Operating Temperature Range	T _j	-65 to +150								°C	
Storage Temperature Range	T _{STG}	-65 to +150								°C	

- Note: 1. Leads maintained at ambient temperature at a distance of 9.5mm from the case
 2. Measured with I_F = 0.5A, I_R = 1.0A, I_{RR} = 0.25A. See figure 5.
 3. Measured at 1.0 MHz and applied reverse voltage of 4.0V D.C.



HER501 THRU HER508

RATINGS AND CHARACTERISTIC CURVES

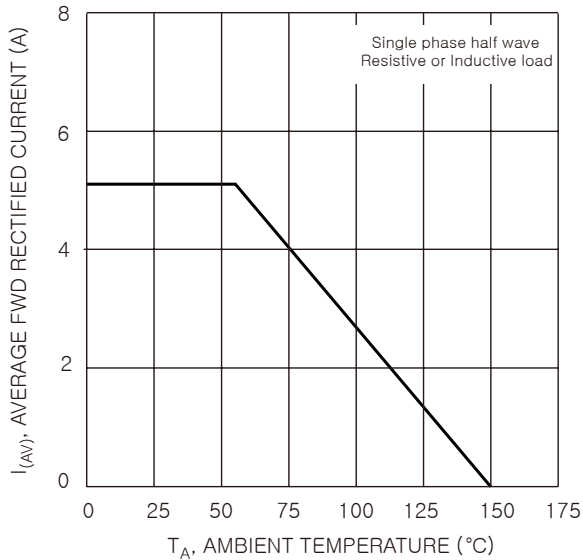

Fig. 1 Forward Current Derating Curve

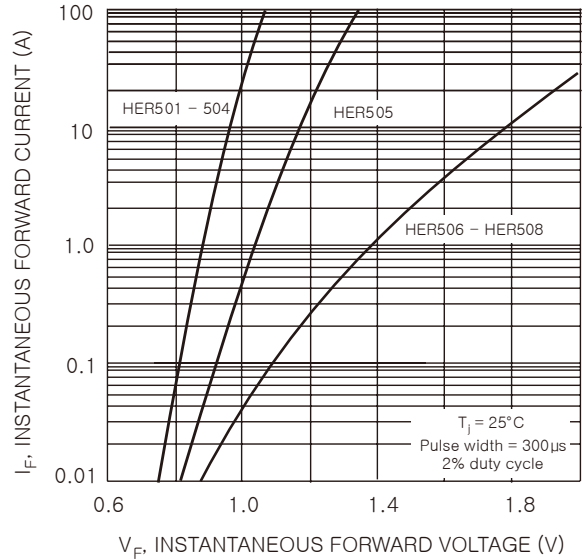

Fig. 2 Typical Forward Characteristics

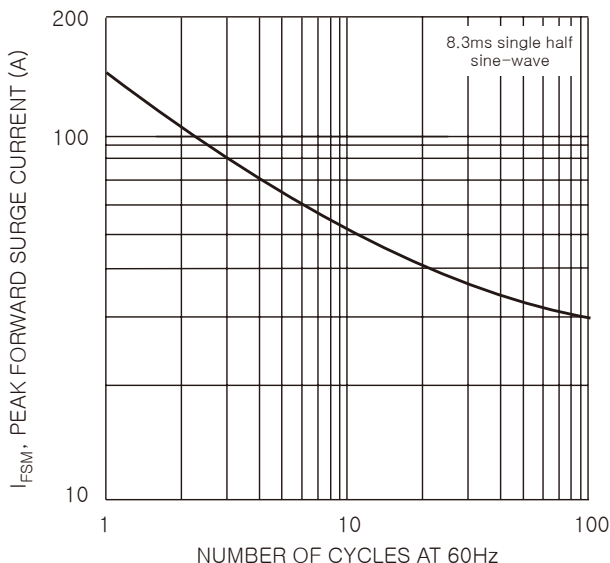

Fig. 3 Peak Forward Surge Current

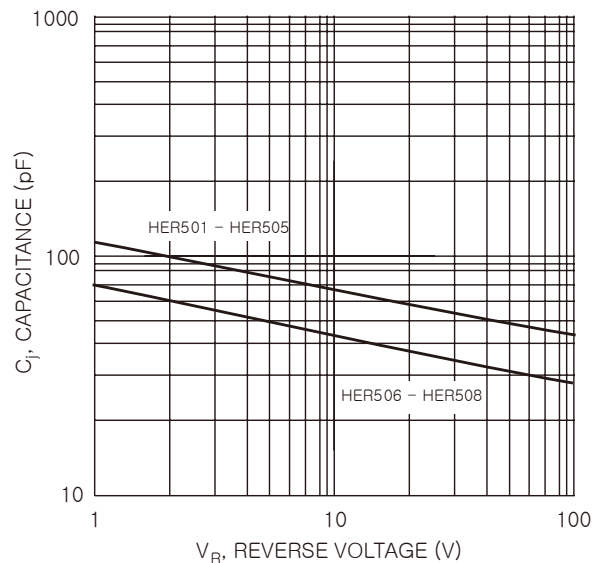
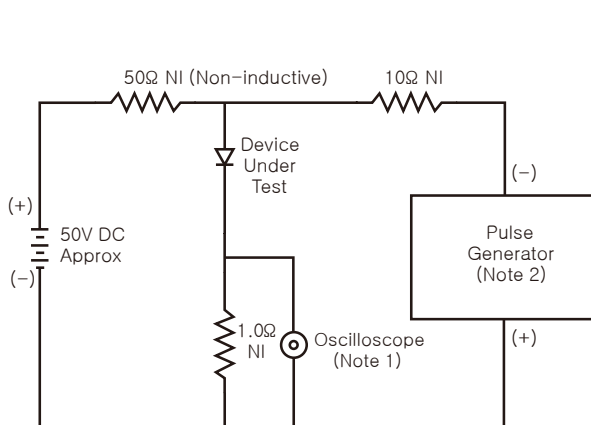
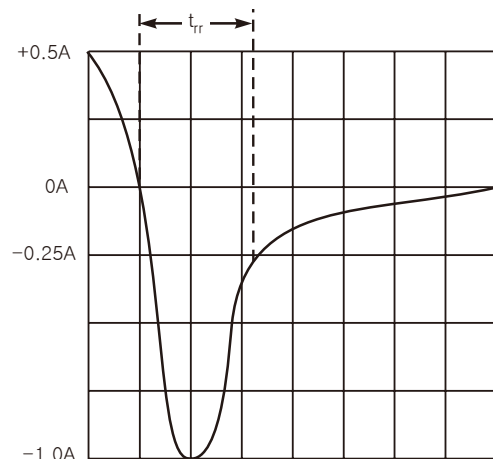

Fig. 4 Typical Junction Capacitance



Notes:

1. Rise Time = 7.0ns max. Input Impedance = 1.0M Ω , 22pF.
2. Rise Time = 10ns max. Input Impedance = 50 Ω .



Set time base for 5/10ns/cm

Fig. 5 Reverse Recovery Time Characteristic and Test Circuit