

891-012 and -013 Series 89 Nanominiature Connectors Double Row Right Angle Surface Mount

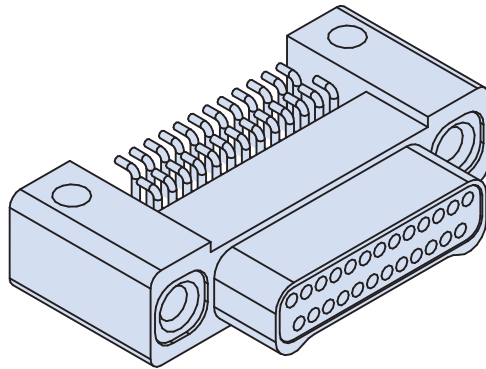

Double Row Connectors



Right Angle Surface Mount PCB Nano Connectors feature gold alloy TwistPin contacts. These nanominiature connectors offer premium performance and reliability for demanding applications. Available with #0-80 female threads, or with jackscrews for use with flexible circuits.

Pre-Tinned PC Tails are coated with Sn63Pb37 tin-lead for excellent solderability.

Choose Aluminum, Titanium or Stainless Steel Shells in seven layouts from 9 to 51 contacts. Complies to the requirements of MIL-DTL-32139.

HOW TO ORDER RIGHT ANGLE SURFACE MOUNT PCB CONNECTORS

Series	Insert Arrangement/ Contact Type	Shell Material and Finish	Termination Type	Hardware
891-012 Plug, Pin Contacts, Double Row, Right Angle Surface Mount Nanominiature	Plugs (891-012) 9P 15P 21P 25P 31P 37P 51P	A1 Aluminum Shell, Cadmium Plating A2 Aluminum Shell, Electroless Nickel Plating	BRS "Board Right Angle Surface Mount"	T #0-80 Female Threads
891-013 Receptacle, Socket Contacts, Double Row, Right Angle Surface Mount Nanominiature	Receptacles (891-013) 9S 15S 21S 25S 31S 37S 51S	T Titanium Shell, Unplated S Stainless Steel Shell, Passivated		
Sample Part Number				
891-012	— 25P	A1	—BRS	T

MATERIALS AND FINISHES

Connector Shell	See Ordering Information
Insulator	Liquid Crystal Polymer (LCP), 30% Glass-Filled
Contacts	Gold Alloy, Unplated
Hardware	300 Series Stainless Steel
PC Tails	#30 (.010 Dia.) Copper Wire, Solder Dipped
PCB Trays	Liquid Crystal Polymer (LCP) or Epoxy
Encapsulant	Epoxy

SPECIFICATIONS

Durability	200 Cycles Minimum
Current Rating	1 AMP Maximum
Voltage Rating (DWV)	300 VAC RMS Sea Level
Insulation Resistance	5000 Megohms Minimum
Operating Temperature	-55° C. to +125° C.
Contact Resistance	71 mV. @1 AMP #30 AWG Wire
Thermal Vacuum Outgassing	1.0% Max TML, 0.1% Max. CVCM

DOUBLE ROW RIGHT ANGLE SURFACE MOUNT NANO DIMENSIONS

Plug (Pin) Connectors

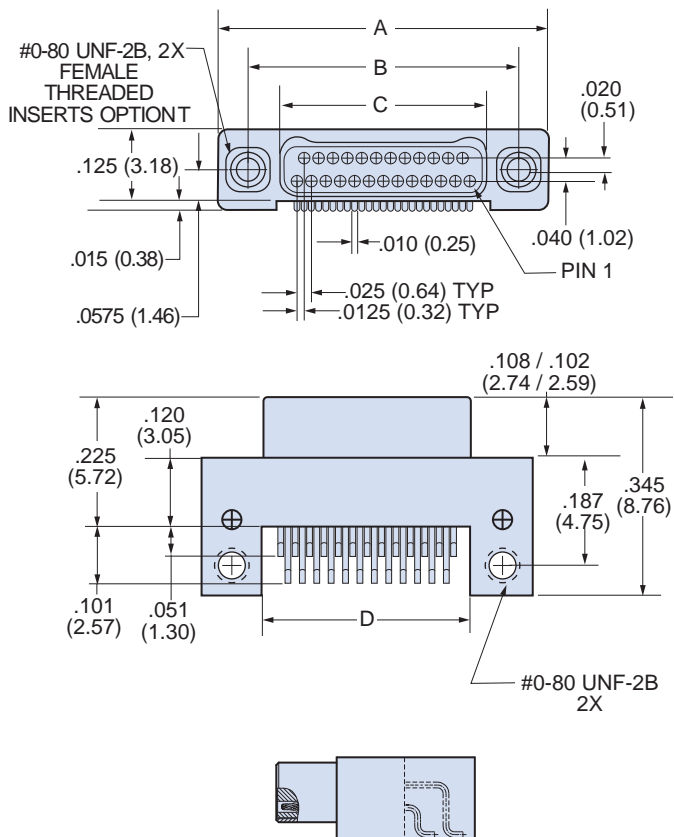

Receptacle (Socket) Connectors

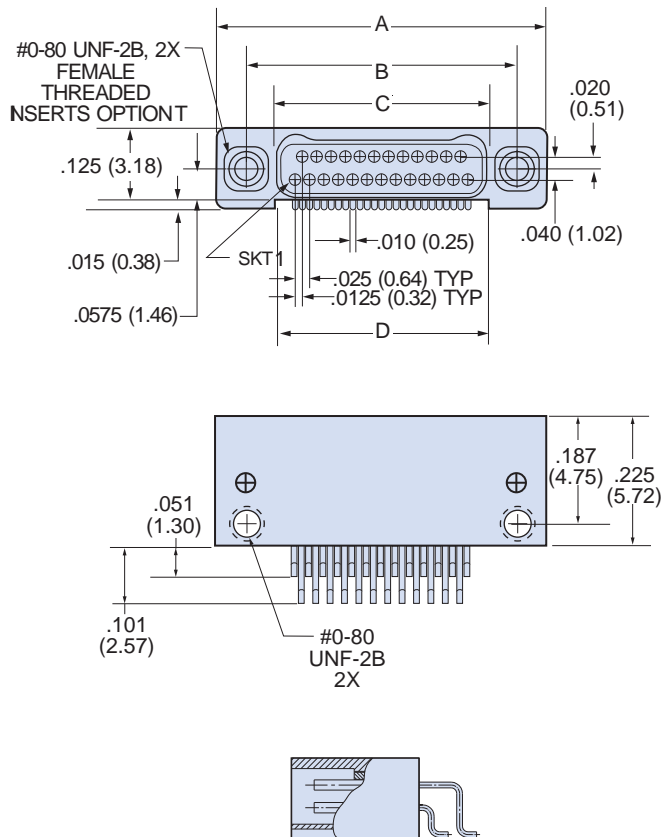

Layout	A		B BSC.		C BSC.		D	
	In. ± .005	mm. ± 0.13	In.	mm.	In.	mm.	In. ± .005	mm. ± 0.13
9P	.375	9.52	.270	6.86	.160	4.06	.170	4.32
9S	.375	9.52	.270	6.86	.163	4.14	.170	4.32
15P	.450	11.43	.345	8.76	.235	5.97	.245	6.22
15S	.450	11.43	.345	8.76	.238	6.04	.245	6.22
21P	.525	13.33	.420	10.67	.310	7.87	.320	8.13
21S	.525	13.33	.420	10.67	.313	7.95	.320	8.13
25P	.575	14.60	.470	11.94	.360	9.14	.370	9.40
25S	.575	14.60	.470	11.94	.363	9.22	.370	9.40
31P	.650	16.51	.545	13.84	.435	11.05	.445	11.30
31S	.650	16.51	.545	13.84	.438	11.12	.445	11.30
37P	.725	18.41	.620	15.75	.510	12.95	.520	13.21
37S	.725	18.41	.620	15.75	.513	13.03	.520	13.21
51P	.900	22.86	.795	20.19	.685	17.40	.695	17.65
51S	.900	22.86	.795	20.19	.688	17.47	.695	17.65

891-012 and -013 Series 89 Nanominiature Connectors Double Row Right Angle Surface Mount



Double Row Connectors

Patterns shown are for connector mounting side of PC Board.

DOUBLE ROW RIGHT ANGLE SURFACE MOUNT BOARD LAYOUT—891-012 PLUGS (PIN CONTACTS)

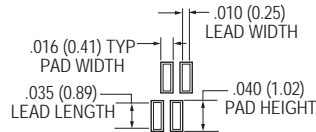

PAD/ FOOTPRINT DETAIL

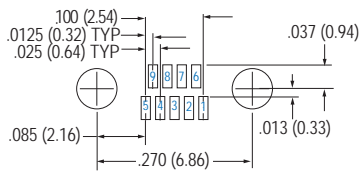

9 Contacts

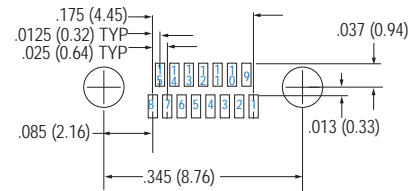

15 Contacts

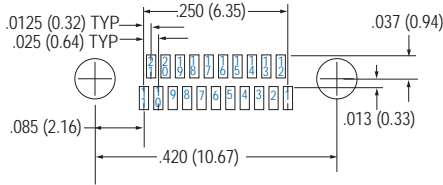

21 Contacts

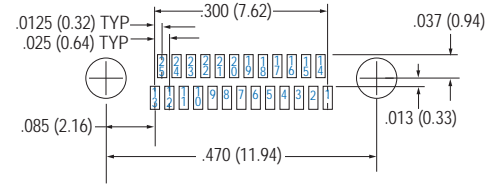

25 Contacts

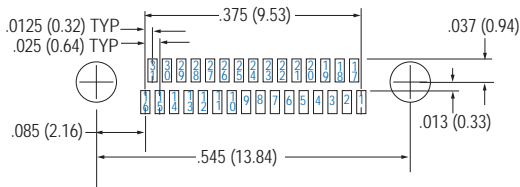

31 Contacts

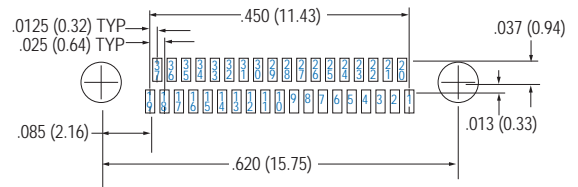

37 Contacts

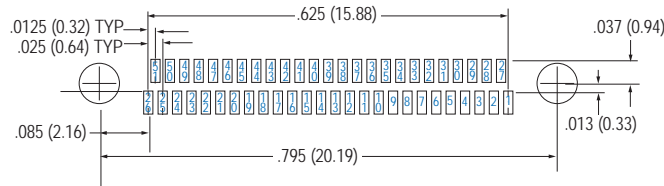

51 Contacts

Patterns shown are for connector mounting side of PC Board.

DOUBLE ROW RIGHT ANGLE SURFACE MOUNT BOARD LAYOUT—891-013 RECEPTACLES

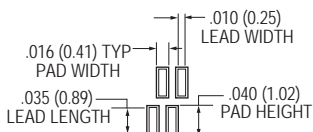

PAD/ FOOTPRINT DETAIL

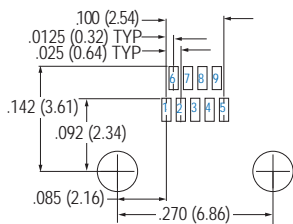

9 Contacts

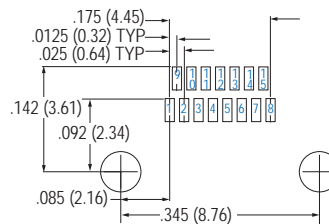

15 Contacts

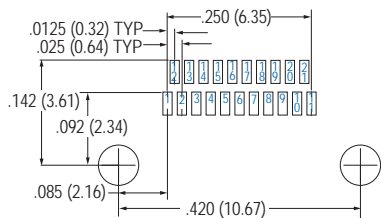

21 Contacts

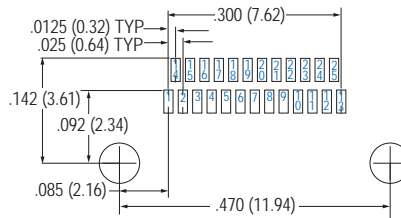

25 Contacts

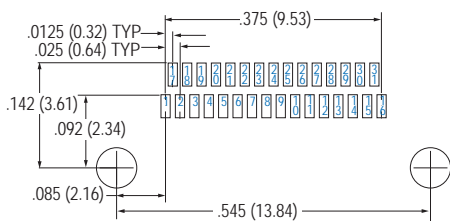

31 Contacts

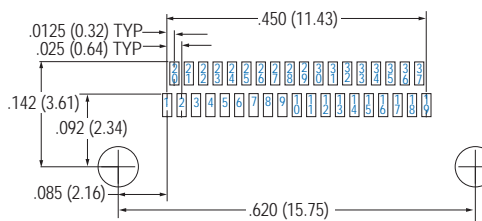

37 Contacts

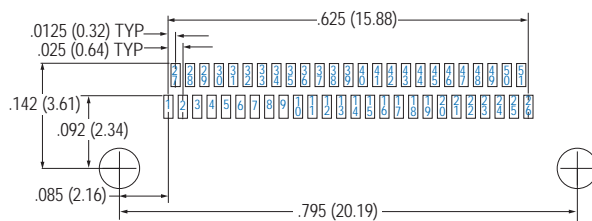

51 Contacts