

**PLEASE CHECK WWW.MOLEX.COM FOR LATEST PART INFORMATION**

**Part Number:** [0754334205](#)  
**Status:** **Active**  
**Overview:** [gbx\\_backplane\\_connector\\_system](#)  
**Description:** 1.85mm by 1.85mm (.073 by .073") Pitch 3-Pair GbX® Backplane Connector System, Right Guide Header, 150 Circuits, Gold (Au) 0.76µm (30µ"), Pin Length 5.55mm (.219")

**Documents:**

[Packaging Specification \(PDF\)](#)      [Product Specification PS-75221-999 \(PDF\)](#)  
[Drawing \(PDF\)](#)      [RoHS Certificate of Compliance \(PDF\)](#)

**Agency Certification**

UL      E29179

**General**

Product Family      Backplane Connectors  
Series      [75433](#)  
Application      Backplane  
Application Tooling Documents      <a href="http://www.molex.com/pdm\_docs/ats/TM-622022099.pdf">Tooling Manual</a>  
Comments      Right Guide Header, No Keying Position  
Component Type      PCB Header  
Overview      [gbx\\_backplane\\_connector\\_system](#)  
Product Name      GbX®  
Style      N/A

**Physical**

Circuits (Loaded)      150  
Circuits (maximum)      150  
Color - Resin      Black  
Durability (mating cycles max)      200  
First Mate / Last Break      No  
Flammability      94V-0  
Guide to Mating Part      Yes  
Keying to Mating Part      None  
Material - Metal      High Performance Alloy (HPA), Stainless Steel  
Material - Plating Mating      Gold  
Material - Plating Termination      Tin-Lead  
Material - Resin      High Temperature Thermoplastic  
Number of Columns      25  
Number of Pairs      3  
Number of Rows      6  
Orientation      Vertical  
PC Tail Length (in)      0.087 In  
PC Tail Length (mm)      2.20 mm  
PCB Locator      No  
PCB Retention      Yes  
PCB Thickness Recommended (in)      0.063 In  
PCB Thickness Recommended (mm)      1.60 mm  
Packaging Type      Tube  
Pitch - Mating Interface (in)      0.073 In  
Pitch - Mating Interface (mm)      1.85 mm  
Pitch - Term. Interface (in)      0.073 In  
Pitch - Term. Interface (mm)      1.85 mm  
Plating min: Mating (µin)      30  
Plating min: Mating (µm)      0.76  
Plating min: Termination (µin)      30

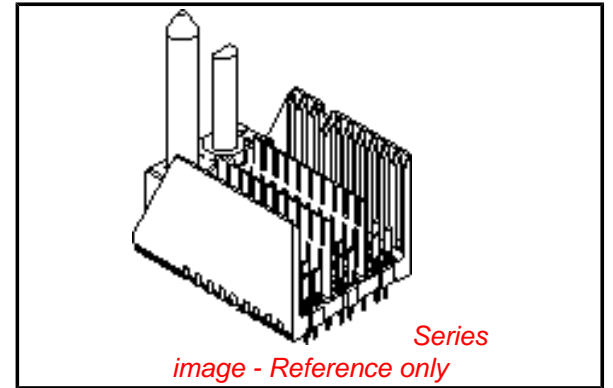

**EU RoHS**

**RoHS Compliant by Exemption**

**REACH SVHC**

**Contains SVHC: No**

**Halogen-Free**

**Status**

**Not Reviewed**

**China RoHS**



**Need more information on product environmental compliance?**

Email [productcompliance@molex.com](mailto:productcompliance@molex.com)  
For a multiple part number RoHS Certificate of Compliance, [click here](#)

Please visit the [Contact Us](#) section for any non-product compliance questions.

**Search Parts in this Series**

[75433Series](#)

**Mates With**

[75370 GbX® Daughtercards](#)

**Application Tooling | FAQ**

*Tooling specifications and manuals are found by selecting the products below. Crimp Height Specifications are then contained in the Application Tooling Specification document.*

**Global**

Description	Product #
GbX® Single Pin Repair Tool	<a href="#">0622022090</a>
GbX® Shield Removal Tool	<a href="#">0622022100</a>
GbX® 3 Pair by 25 Wide Differential Insertion Tool	<a href="#">0622022530</a>

Plating min: Termination (µm)	0.76
Polarized to PCB	No
Stackable	No
Surface Mount Compatible (SMC)	Yes
Temperature Range - Operating	105°C
Termination Interface: Style	Through Hole - Compliant Pin

### **Electrical**

Current - Maximum per Contact	1A
Data Rate	8.0 Gbps
Real Signals (per 25mm)	81
Shield Type	Ground Plane Shield
Shielded	Yes
Voltage - Maximum	120V AC (RMS)/DC

### **Material Info**

#### **Reference - Drawing Numbers**

Product Specification	PS-75221-999
Sales Drawing	SD-75433-410

GbX is a registered trademark of Amphenol Corporation.

This document was generated on 05/14/2010

**PLEASE CHECK [WWW.MOLEX.COM](http://WWW.MOLEX.COM) FOR LATEST PART INFORMATION**

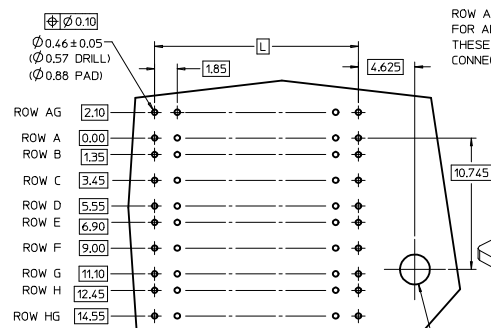
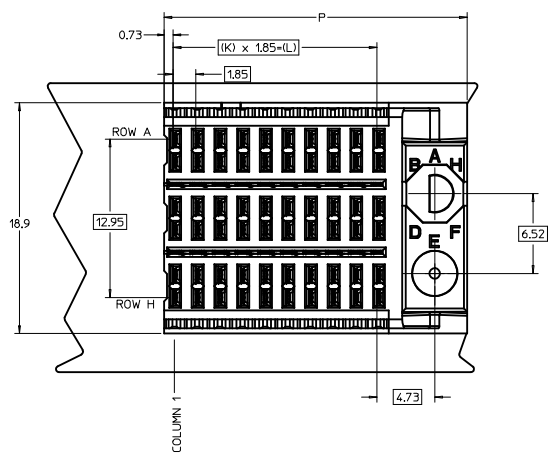

ROW AG & HG RECOMMENDED FOR ALL APPLICATIONS. THESE ROWS SHOULD BE CONNECTED TO GROUND.

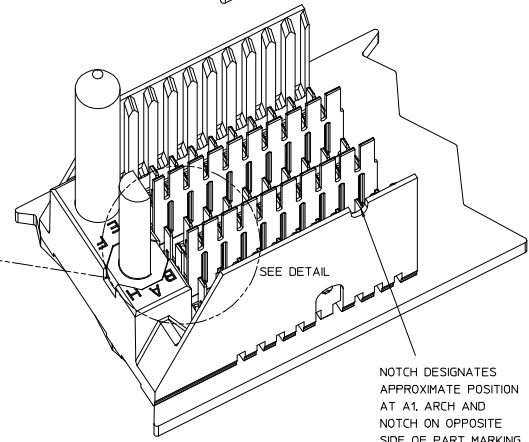
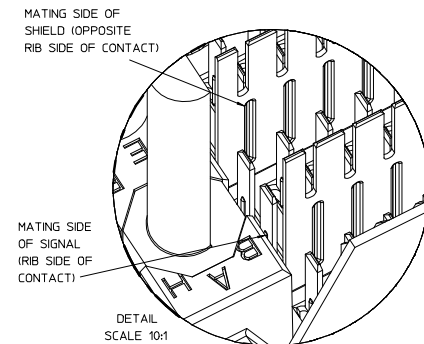
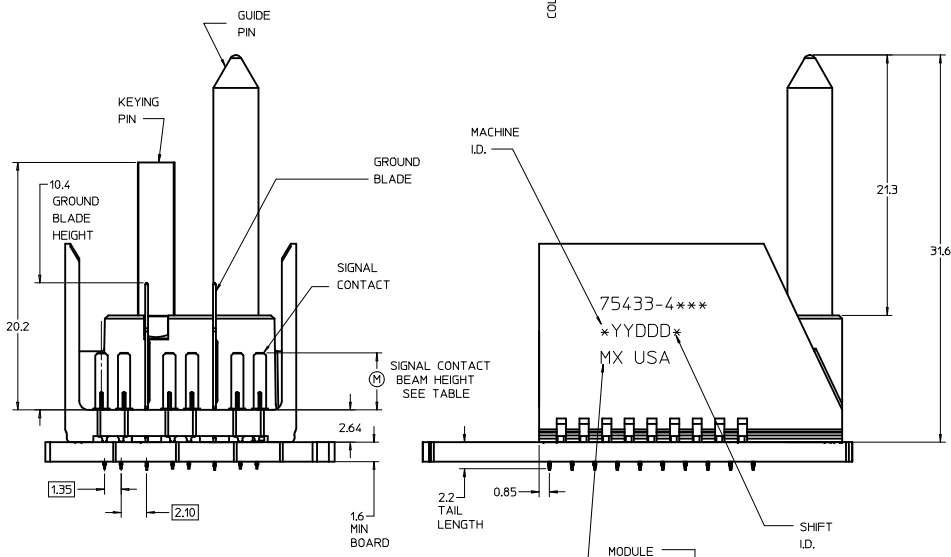
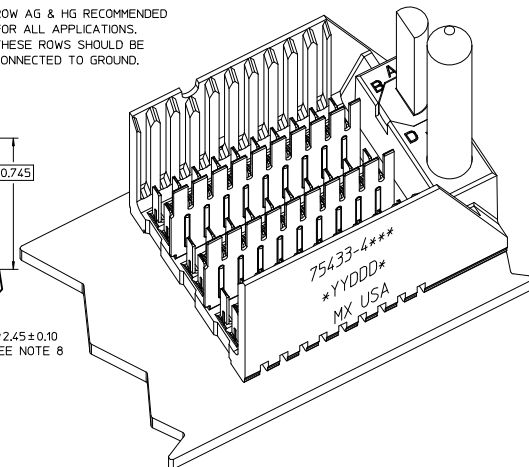

NOTCH DESIGNATES APPROXIMATE POSITION AT A1 ARCH AND NOTCH ON OPPOSITE SIDE OF PART MARKING.

NOTES:

- MATERIAL: HOUSING - LIQUID CRYSTAL POLYMER (LCP) GLASS-FILLED. UL 94V-0, COLOR - GRAY, SIGNAL CONTACT AND GROUND BLADE - HIGH PERFORMANCE COPPER ALLOY.
- FINISHES: SELECTIVE GOLD (Au) ON CONTACT AREA. SELECTIVE TIN/LEAD (Sn/Pb) ON PCB TAILS. NICKEL (Ni) OVERALL.
- THIS PART CONFORMS TO MOLEX PRODUCT SPECIFICATION PS-75221-999.
- FOR MIXED CONTACT MATING LENGTHS CONSULT MOLEX FOR AVAILABILITY. CONTACT PAIRS MUST BE THE SAME LENGTH.
- FOR SPECIFIC PART NUMBER AND MATING INFORMATION PLEASE REFER TO CHART.
- PACKAGE PER PK-70873-572.
- EITHER MARK PART NUMBER AND DATE CODE APPROXIMATELY WHERE SHOWN OR PLACE A LABEL ON THE TUBE.
- OPTIONAL HOLE LOCATION FOR GROUNDED GUIDE PIN OR ADDITIONAL GUIDE PIN SUPPORT. FOR GROUNDED GUIDE PIN, HOLE TO BE PLATED, DRILL SIZE Ø2.58, PAD SIZE Ø5.50
- THESE PARTS CONFORM TO MOLEX COSMETIC SPECIFICATION PS-45499-002 CLASS B.

75433-4\*\*\*

KEYING ORIENTATION  
0-NONE  
1-A  
2-B  
ETC...

MODULE ORIENTATION  
RIGHT = 4

PIN LENGTH DIM "M"  
3=3.55 mm  
4=4.55 mm  
5=5.55 mm

PART NUMBER TABLE				
ASSY PART NO.	K	L	P	TOTAL NO. OF DIFFERENTIAL PAIRS
75433-41**	9	16.65	24.78	30
75433-42**	24	44.40	52.53	75
75433-45**	4	7.40	15.53	15

P/N	--*0*	--*1*	--*2*	--*3*	--*4*	--*5*	--*6*	--*7*	--*8*
75433-( )	0	A	B	C	D	E	F	G	H
KEYING PIN ORIENTATION									

REVISED (MINOR) EC NO: UCP2009-1704 DRAWN: BINGHAM 2009/01/12 CHKD: CHIKD 2009/01/12 APPR: LAURX 2009/01/13	QUALITY SYMBOLS -0 -0	GENERAL TOLERANCES (UNLESS SPECIFIED)		SCALE	DESIGN UNITS	THIRD ANGLE PROJECTION REVISE ON CAD ONLY
		4 PLACES ± --- ± --- 3 PLACES ± --- ± --- 2 PLACES ± --- ± --- 1 PLACE ± --- ± ---		MM ONLY	MM ONLY	
		ANGULAR ± ---°		DRAWN BY: NMARTIN DATE: 2005/02/20	CHECKED BY: SREED DATE: 2005/02/20	
		DRAFT WHERE APPLICABLE MUST REMAIN WITHIN DIMENSIONS		APPROVED BY: CBIXLER DATE: 2005/02/20	MATERIAL NO. SEE CHART DOCUMENT NO. SD-75433-410	
THIS DRAWING CONTAINS INFORMATION THAT IS PROPRIETARY TO MOLEX INCORPORATED AND SHOULD NOT BE USED WITHOUT WRITTEN PERMISSION						MOLEX MOLEX INCORPORATED SHEET NO. 1 OF 1