

General Description

The MIC7300 is a high-performance CMOS operational amplifier featuring rail-to-rail input and output with strong output drive capability. It is able to source and sink in excess of 80mA into large capacitive loads.

The input common-mode range extends beyond the rails by 300mV, and the output voltage typically swings to within 150µV of both rails when driving a 100kΩ load.

The amplifier operates from 2.2V to 10V and is fully specified at 2.2V, 3V, 5V, and 10V. Gain bandwidth and slew rate are 500kHz and 0.5V/µs, respectively.

The MIC7300 is available in Micrel's IttyBitty™ SOT-23-5 package for space-conscious circuits and in high-power MM8™ 8-lead MSOP for improved heat dissipation in higher power applications.

Pin Configurations

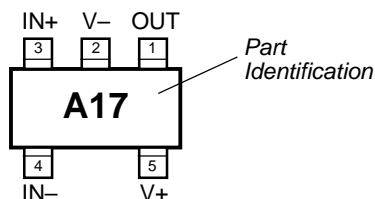

SOT-23-5 (M5)

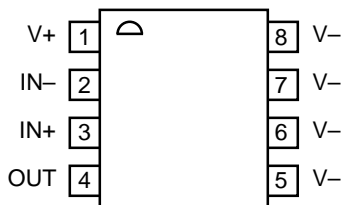

MSOP-8 (MM)

Features

- Small footprint SOT-23-5 and power MSOP-8 packages
- >80mA peak output sink and source with 5V supply
- Drives large capacitive loads (6000pF with 10V supply)
- Guaranteed 2.2V, 3V, 5V, and 10V performance
- 500kHz gain-bandwidth product
- 0.01% total harmonic distortion at 1kHz (10V, 2kΩ)
- 1mA typical power supply current at 5V

Applications

- Battery-powered instrumentation
- PCMCIA, USB peripherals
- Portable computers and PDAs

Ordering Information

Part Number			
Standard	Pb-free	Temp. Range	Package
MIC7300BM5	MIC7300YM5	-40°C to +85°C	SOT-23-5
MIC7300BMM	MIC7300YMM	-40°C to +85°C	MSOP-8

Functional Configuration

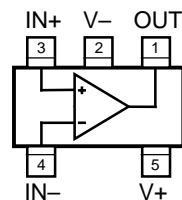

SOT-23-5 (M5)

Pin Description

Pin Number SOT-23-5	Pin Number MSOP-8	Pin Name	Pin Function
1	4	OUT	Amplifier Output
2	5-8	V-	Negative Supply: Negative supply for split supply application or ground for single supply application.
3	3	IN+	Noninverting Input
4	2	IN-	Inverting Input
5	1	V+	Positive Supply

IttyBitty and MM8 are trademarks of Micrel, Inc.

Micrel, Inc. • 2180 Fortune Drive • San Jose, CA 95131 • USA • tel + 1 (408) 944-0800 • fax + 1 (408) 474-1000 • <http://www.micrel.com>

Absolute Maximum Ratings (Note 1)

Supply Voltage ($V_{V+} - V_{V-}$)	12V
Differential Input Voltage ($V_{IN+} - V_{IN-}$)	$\pm 12V$
I/O Pin Voltage (V_{IN}, V_{OUT}), Note 3	$V_{V+} + 0.3V$ to $V_{V-} - 0.3V$
Junction Temperature (T_J)	$+150^\circ C$
Storage Temperature	$-65^\circ C$ to $+150^\circ C$
Lead Temperature (soldering, 10 sec.)	$260^\circ C$
ESD, Note 6	

Operating Ratings (Note 2)

Supply Voltage ($V_{V+} - V_{V-}$)	2.2V to 10V
Junction Temperature (T_J)	$-40^\circ C$ to $+85^\circ C$
Package Thermal Resistance, Note 5	
SOT-23-5 (θ_{JA})	$260^\circ C/W$
MSOP-8 (θ_{JA})	$85^\circ C/W$
Max. Power Dissipation	Note 4

DC Electrical Characteristics (2.2V)

$V_{V+} = +2.2V$, $V_{V-} = 0V$, $V_{CM} = V_{OUT} = V_{V+}/2$; $R_L = 1M\Omega$; $T_J = 25^\circ C$, **bold** values indicate $-40^\circ C \leq T_J \leq +85^\circ C$; **Note 7**; unless noted

Symbol	Parameter	Condition	Min	Typ	Max	Units
V_{OS}	Input Offset Voltage			1.0	9	mV
TCV_{OS}	Input Offset Voltage Average Drift			1.0		$\mu V/^\circ C$
I_B	Input Bias Current			0.5		pA
I_{OS}	Input Offset Current			0.25		pA
R_{IN}	Input Resistance			>1		$T\Omega$
CMRR	Common-Mode Rejection Ratio	$0V \leq V_{CM} \leq 2.2V$, Note 9	45	65		dB
V_{CM}	Input Common-Mode Voltage	input low, CMRR $\geq 45dB$		-0.3	0.0	V
		input high, CMRR $\geq 45dB$	2.2	2.5		V
$\pm PSRR$	Power Supply Rejection Ratio	$V_{V+} = V_{V-} = 1.1V$ to $2.5V$, $V_{CM} = 0$	55	75		dB
C_{IN}	Common-Mode Input Capacitance			3		pF
V_O	Output Swing	output high, $R_L = 100k$, specified as $V_{V+} - V_{OUT}$		0.15	1	mV
		output low, $R_L = 100k$		0.15	1	mV
		output high, $R_L = 2k$ specified as $V_{V+} - V_{OUT}$		10	33	mV
		output low, $R_L = 2k$		10	33	mV
		output high, $R_L = 600\Omega$ specified as $V_{V+} - V_{OUT}$		33	110	mV
		output low, $R_L = 600\Omega$		33	110	mV
I_{SC}	Output Short Circuit Current	sinking or sourcing, Note 8	20	40		mA
I_S	Supply Current	$V_{OUT} = V_{V+}/2$		0.7	2.0	mA

AC Electrical Characteristics (2.2V)

$V_{V+} = 2.2V$, $V_{V-} = 0V$, $V_{CM} = V_{OUT} = V_{V+}/2$; $R_L = 1M\Omega$; $T_J = 25^\circ C$, **bold** values indicate $-40^\circ C \leq T_J \leq +85^\circ C$; **Note 7**; unless noted

Symbol	Parameter	Condition	Min	Typ	Max	Units
SR	Slew Rate			0.5		V/ μs
GBW	Gain-Bandwidth Product			0.55		MHz
ϕ_m	Phase Margin	$C_L = 0pF$		80		$^\circ$
		$C_L = 2500pF$		40		$^\circ$
G_m	Gain Margin			10		dB

DC Electrical Characteristics (3.0V)

$V_{V+} = +3.0V$, $V_{V-} = 0V$, $V_{CM} = V_{OUT} = V_{V+}/2$; $R_L = 1M\Omega$; $T_J = 25^\circ C$, **bold** values indicate $-40^\circ C \leq T_J \leq +85^\circ C$; **Note 7**; unless noted

Symbol	Parameter	Condition	Min	Typ	Max	Units
V_{OS}	Input Offset Voltage			1.0	9	mV
TCV_{OS}	Input Offset Voltage Average Drift			1.0		$\mu V/^\circ C$
I_B	Input Bias Current			0.5		pA
I_{OS}	Input Offset Current			0.25		pA
R_{IN}	Input Resistance			>1		$T\Omega$
CMRR	Common-Mode Rejection Ratio	$0V \leq V_{CM} \leq 3.0V$, Note 9	50	70		dB
V_{CM}	Input Common-Mode Voltage	input low, CMRR ≥ 50 dB		-0.3	0	V
		input high, CMRR ≥ 50 dB	3.0	3.3		V
$\pm PSRR$	Power Supply Rejection Ratio	$V_{V+} = V_{V-} = 1.5V$ to $5.0V$, $V_{CM} = 0$	55	75		dB
C_{IN}	Common-Mode Input Capacitance			3		pF
V_{OUT}	Output Swing	output high, $R_L = 100k$ specified as $V_{V+} - V_{OUT}$		0.2	1	mV mV
		output low, $R_L = 100k$		0.2	1	mV mV
		output high, $R_L = 2k$ specified as $V_{V+} - V_{OUT}$		10	33 50	mV mV
		output low, $R_L = 2k$		10	33 50	mV mV
		output high, $R_L = 600\Omega$ specified as $V_{V+} - V_{OUT}$		33	110 165	mV mV
		output low, $R_L = 600\Omega$		33	110 165	mV mV
I_{SC}	Output Short Circuit Current	sinking or sourcing, Note 8	60	95		mA
I_S	Supply Current			0.8	2.2	mA

AC Electrical Characteristics (3V)

$V_{V+} = 3V$, $V_{V-} = 0V$, $V_{CM} = 1.5V$, $V_{OUT} = V_{V+}/2$; $R_L = 1M\Omega$; $T_J = 25^\circ C$, **bold** values indicate $-40^\circ C \leq T_J \leq +85^\circ C$; **Note 7**; unless noted

Symbol	Parameter	Condition	Min	Typ	Max	Units
SR	Slew Rate			0.5		V/ μs
GBW	Gain-Bandwidth Product			0.45		MHz
ϕ_m	Phase Margin	$C_L = 0pF$		85		$^\circ$
		$C_L = 3500pF$		40		$^\circ$
G_m	Gain Margin			10		dB

DC Electrical Characteristics (5V)

$V_{V+} = +5.0V$, $V_{V-} = 0V$, $V_{CM} = 1.5V$, $V_{OUT} = V_{V+}/2$; $R_L = 1M\Omega$; $T_J = 25^\circ C$, **bold** values indicate $-40^\circ C \leq T_J \leq +85^\circ C$; **Note 7**; unless noted

Symbol	Parameter	Condition	Min	Typ	Max	Units
V_{OS}	Input Offset Voltage			1.0	9	mV
TCV_{OS}	Input Offset Voltage Average Drift			1.0		$\mu V/^\circ C$
I_B	Input Bias Current			0.5		pA
I_{OS}	Input Offset Current			0.25		pA
R_{IN}	Input Resistance			>1		$T\Omega$
CMRR	Common-Mode Rejection Ratio	$0V \leq V_{CM} \leq 5V$, Note 9	55	80		dB
V_{CM}	Input Common-Mode Voltage	input low, CMRR ≥ 55 dB		-0.3	-0.0	V
		input high, CMRR ≥ 55 dB	5.0	5.3		V
$\pm PSRR$	Power Supply Rejection Ratio	$V_{V+} = V_{V-} = 2.5V$ to $5.0V$, $V_{CM} = 0$	55	75		dB
C_{IN}	Common-Mode Input Capacitance			3		pF
V_{OUT}	Output Swing	output high, $R_L = 100k$ specified as $V_{V+} - V_{OUT}$		0.3	1.0 1.5	mV mV
		output low, $R_L = 100k$		0.3	1.0 1.5	mV mV
		output high, $R_L = 2k$ specified as $V_{V+} - V_{OUT}$		15	50 75	mV mV
		output low, $R_L = 2k$		15	50 75	mV mV
		output high, $R_L = 600\Omega$ specified as $V_{V+} - V_{OUT}$		50	165 250	mV mV
		output low, $R_L = 600\Omega$		50	165 250	mV mV
I_{SC}	Output Short Circuit Current	sinking or sourcing, Note 8	85	105		mA
I_S	Supply Current	$V_{OUT} = V+/2$		1.0	2.8	mA

AC Electrical Characteristics (5V)

$V_{V+} = 5V$, $V_{V-} = 0V$, $V_{CM} = 1.5V$, $V_{OUT} = V_{V+}/2$; $R_L = 1M\Omega$; $T_J = 25^\circ C$, **bold** values indicate $-40^\circ C \leq T_J \leq +85^\circ C$; **Note 7**; unless noted

Symbol	Parameter	Condition	Min	Typ	Max	Units
THD	Total Harmonic Distortion	$f = 1kHz$, $A_V = -2$, $R_L = 2k\Omega$, $V_{OUT} = 4.0 V_{PP}$		0.05		%
SR	Slew Rate			0.5		$V/\mu s$
GBW	Gain-Bandwidth Product			0.4		MHz
ϕ_m	Phase Margin	$C_L = 0pF$		85		$^\circ$
		$C_L = 4500pF$		40		$^\circ$
G_m	Gain Margin			10		dB

DC Electrical Characteristics (10V)

$V_{V+} = +10V$, $V_{V-} = 0V$, $V_{CM} = 1.5V$, $V_{OUT} = V_{V+}/2$; $R_L = 1M\Omega$; $T_J = 25^\circ C$, **bold** values indicate $-40^\circ C \leq T_J \leq +85^\circ C$; **Note 7**; unless noted

Symbol	Parameter	Condition	Min	Typ	Max	Units
V_{OS}	Input Offset Voltage			1.0	9	mV
TCV_{OS}	Input Offset Voltage Average Drift			1.0		$\mu V/^\circ C$
I_B	Input Bias Current			0.5		pA
I_{OS}	Input Offset Current			0.25		pA
R_{IN}	Input Resistance			>1		$T\Omega$
CMRR	Common-Mode Rejection Ratio	$0V \leq V_{CM} \leq 10V$, Note 9	60	85		dB
V_{CM}	Input Common-Mode Voltage	input low, $V_+ = 10V$, CMRR $\geq 60dB$		-0.3	-0.0	V
		input high, $V_+ = 10V$, CMRR $\geq 60dB$	10.0	10.3		V
$\pm PSRR$	Power Supply Rejection Ratio	$V_{V+} = V_{V-} = 2.5V$ to $5.0V$, $V_{CM} = 0$	55	75		dB
A_V	Large Signal Voltage Gain	sourcing or sinking, $R_L = 2k$, Note 10	80	340		V/mV
		sourcing or sinking, $R_L = 600\Omega$, Note 10	15	300		V/mV
C_{IN}	Common-Mode Input Capacitance			3		pF
V_{OUT}	Output Swing	output high, $R_L = 100k$ specified as $V_{V+} - V_{OUT}$		0.5	1.5 2.5	mV mV
		output low, $R_L = 100k$		0.5	1.5 2.5	mV mV
		output high, $R_L = 2k$ specified as $V_{V+} - V_{OUT}$		24	80 120	mV mV
		output low, $R_L = 2k$		24	80 120	mV mV
		output high, $R_L = 600\Omega$ specified as $V_{V+} - V_{OUT}$		80	270 400	mV mV
		output low, $R_L = 600\Omega$		80	270 400	mV mV
I_{SC}	Output Short Circuit Current	sinking or sourcing, Notes 8	90	115		mA
I_S	Supply Current	$V_{OUT} = V_+/2$		1.5	4.0	mA

AC Electrical Characteristics (10V)

$V_{V+} = 10V$, $V_{V-} = 0V$, $V_{CM} = 1.5V$, $V_{OUT} = V_{V+}/2$; $R_L = 1M\Omega$; $T_J = 25^\circ C$, **bold** values indicate $-40^\circ C \leq T_J \leq +85^\circ C$; **Note 7**; unless noted

Symbol	Parameter	Condition	Min	Typ	Max	Units
THD	Total Harmonic Distortion	$f = 1kHz$, $A_V = -2$, $R_L = 2k$, $V_{OUT} = 8.5 V_{PP}$		0.01		%
SR	Slew Rate	$V_+ = 10V$, Note 11		0.5		V/ μs V/ μs
GBW	Gain-Bandwidth Product			0.37		MHz
ϕ_m	Phase Margin	$C_L = 0pF$		85		$^\circ$
		$C_L = 6000pF$		40		$^\circ$
G_m	Gain Margin			10		dB
e_n	Input-Referred Voltage Noise	$f = 1kHz$, $V_{CM} = 1V$		37		nV/\sqrt{Hz}
i_n	Input-Referred Current Noise	$f = 1kHz$		1.5		fA/\sqrt{Hz}

- Note 1.** Exceeding the absolute maximum rating may damage the device.
- Note 2.** The device is not guaranteed to function outside its operating rating.
- Note 3.** I/O Pin Voltage is any external voltage to which an input or output is referenced.
- Note 4.** The maximum allowable power dissipation is a function of the maximum junction temperature, $T_{J(max)}$; the junction-to-ambient thermal resistance, θ_{JA} ; and the ambient temperature, T_A . The maximum allowable power dissipation at any ambient temperature is calculated using: $P_D = (T_{J(max)} - T_A) \div \theta_{JA}$. Exceeding the maximum allowable power dissipation will result in excessive die temperature.
- Note 5.** Thermal resistance, θ_{JA} , applies to a part soldered on a printed-circuit board.
- Note 6.** Devices are ESD protected; however, handling precautions are recommended.
- Note 7.** All limits guaranteed by testing or statistical analysis.
- Note 8.** Continuous short circuit may exceed absolute maximum T_J under some conditions.
- Note 9.** CMRR is determined as follows: The maximum ΔV_{OS} over the V_{CM} range is divided by the magnitude of the V_{CM} range. The measurement points are: V_{V-} , $(V_{V+} - V_{V-})/2$, and V_{V+} .
- Note 10.** R_L connected to 5V. Sourcing: $5V \leq V_{OUT} \leq 10V$. Sinking: $2.5V \leq V_{OUT} \leq 5V$.
- Note 11.** Device connected as a voltage follower with a 10V step input. The value is the positive or negative slew rate, whichever is slower.

Typical Characteristics

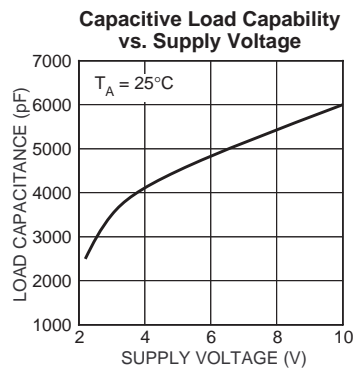
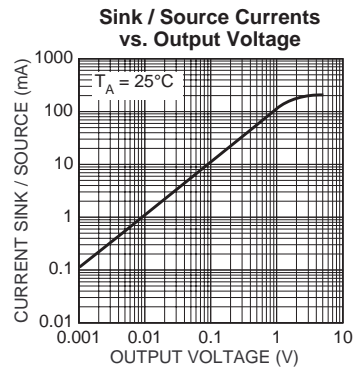
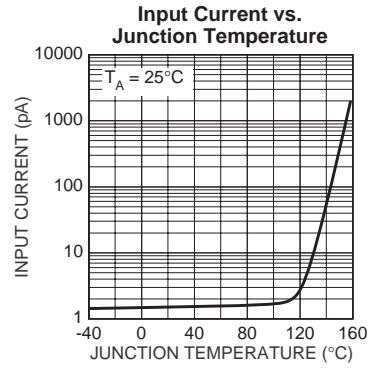

Application Information

Input Common-Mode Voltage

The MIC7300 tolerates input overdrive by at least 300mV beyond either rail without producing phase inversion.

If the absolute maximum input voltage is exceeded, the input current should be limited to $\pm 5\text{mA}$ maximum to prevent reducing reliability. A $10\text{k}\Omega$ series input resistor, used as a current limiter, will protect the input structure from voltages as large as 50V above the supply or below ground. See Figure 1.

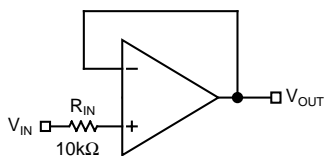

Figure 1. Input Current-Limit Protection

Output Voltage Swing

Sink and source output resistances of the MIC7300 are equal. Maximum output voltage swing is determined by the load and the approximate output resistance. The output resistance is:

$$R_{\text{OUT}} = \frac{V_{\text{DROP}}}{I_{\text{LOAD}}}$$

V_{DROP} is the voltage dropped within the amplifier output stage. V_{DROP} and I_{LOAD} can be determined from the V_{O} (output swing) portion of the appropriate Electrical Characteristics table. I_{LOAD} is equal to the typical output high voltage minus $V_{+}/2$ and divided by R_{LOAD} . For example, using the Electrical Characteristics DC (5V) table, the typical output high voltage using a $2\text{k}\Omega$ load (connected to $V_{+}/2$) is 4.985V, which produces an I_{LOAD} of:

$$\left(\frac{4.985\text{V} - 2.5\text{V}}{2\text{k}\Omega} \right) = 1.243\text{mA}.$$

Voltage drop in the amplifier output stage is:

$$V_{\text{DROP}} = 5.0\text{V} - 4.985\text{V}$$

$$V_{\text{DROP}} = 0.015\text{V}$$

Because of output stage symmetry, the corresponding typical output low voltage (0.015V) also equals V_{DROP} . Then:

$$R_{\text{OUT}} = \frac{0.015\text{V}}{0.001243\text{A}} = 12\Omega$$

Power Dissipation

The MIC7300 output drive capability requires considering power dissipation. If the load impedance is low, it is possible to damage the device by exceeding the 125°C junction temperature rating.

On-chip power consists of two components: supply power and output stage power. Supply power (P_{S}) is the product of the supply voltage ($V_{\text{S}} = V_{\text{V}+} - V_{\text{V}-}$) and supply current (I_{S}).

Output stage power (P_{O}) is the product of the output stage voltage drop (V_{DROP}) and the output (load) current (I_{OUT}). Total on-chip power dissipation is:

$$P_{\text{D}} = P_{\text{S}} + P_{\text{O}}$$

$$P_{\text{D}} = V_{\text{S}} I_{\text{S}} + V_{\text{DROP}} I_{\text{OUT}}$$

where:

P_{D} = total on-chip power

P_{S} = supply power dissipation

P_{O} = output power dissipation

$$V_{\text{S}} = V_{\text{V}+} - V_{\text{V}-}$$

I_{S} = power supply current

$$V_{\text{DROP}} = V_{\text{V}+} - V_{\text{OUT}} \quad (\text{sourcing current})$$

$$V_{\text{DROP}} = V_{\text{OUT}} - V_{\text{V}-} \quad (\text{sinking current})$$

The above addresses only steady state (dc) conditions. For non-dc conditions the user must estimate power dissipation based on rms value of the signal.

The task is one of determining the allowable on-chip power dissipation for operation at a given ambient temperature and power supply voltage. From this determination, one may calculate the maximum allowable power dissipation and, after subtracting P_{S} , determine the maximum allowable load current, which in turn can be used to determine the minimum load impedance that may safely be driven. The calculation is summarized below.

$$P_{\text{D(max)}} = \frac{T_{\text{J(max)}} - T_{\text{A}}}{\theta_{\text{JA}}}$$

$$\theta_{\text{JA(SOT-23-5)}} = 260^{\circ}\text{C/W}$$

$$\theta_{\text{JA(MSOP-8)}} = 85^{\circ}\text{C/W}$$

Driving Capacitive Loads

Driving a capacitive load introduces phase-lag into the output signal, and this in turn reduces op-amp system phase margin. The application that is least forgiving of reduced phase margin is a unity gain amplifier. The MIC7300 can typically drive a 2500pF capacitive load connected directly to the output when configured as a unity-gain amplifier and powered with a 2.2V supply. At 10V operation the circuit typically drives 6000pF . Phase margin is typically 40° .

Using Large-Value Feedback Resistors

A large-value feedback resistor ($> 500\text{k}\Omega$) can reduce the phase margin of a system. This occurs when the feedback resistor acts in conjunction with input capacitance to create phase lag in the feedback signal. Input capacitance is usually a combination of input circuit components and other parasitic capacitance, such as amplifier input capacitance and stray printed circuit board capacitance.

Figure 2 illustrates a method of compensating phase lag caused by using a large-value feedback resistor. Feedback capacitor C_{FB} introduces sufficient phase lead to overcome

the phase lag caused by feedback resistor R_{FB} and input capacitance C_{IN} . The value of C_{FB} is determined by first estimating C_{IN} and then applying the following formula:

$$R_{IN} \times C_{IN} \leq R_{FB} \times C_{FB}$$

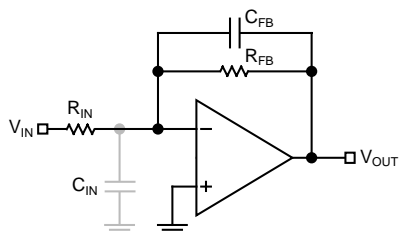

Figure 2. Cancelling Feedback Phase Lag

Since a significant percentage of C_{IN} may be caused by board layout, it is important to note that the correct value of C_{FB} may change when changing from a breadboard to the final circuit layout.

Typical Circuits

Some single-supply, rail-to-rail applications for which the MIC7300 is well suited are shown in the circuit diagrams of Figures 3 through 7.

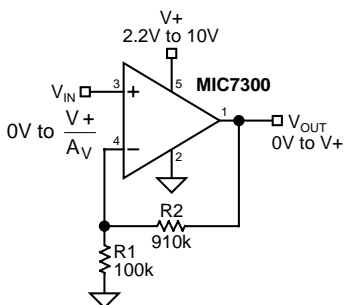

Figure 3a. Noninverting Amplifier

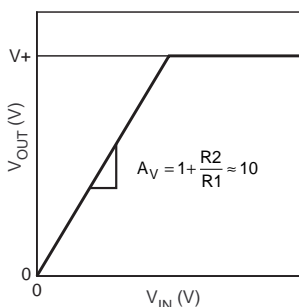

Figure 3b. Noninverting Amplifier Behavior

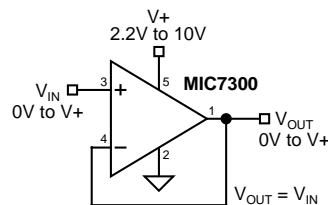

Figure 4. Voltage Follower/Buffer

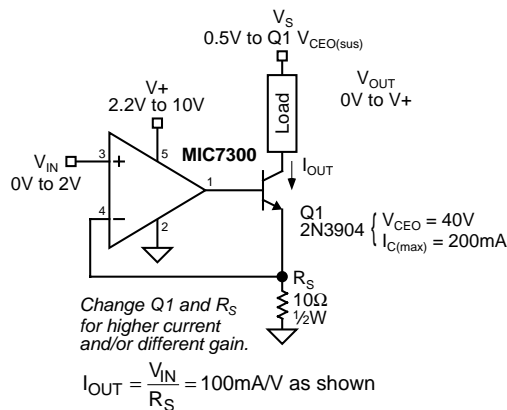

Figure 5. Voltage-Controlled Current Sink

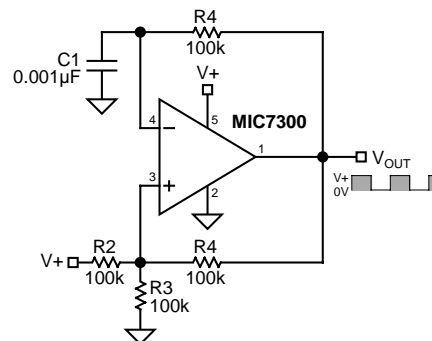

Figure 6. Square Wave Oscillator

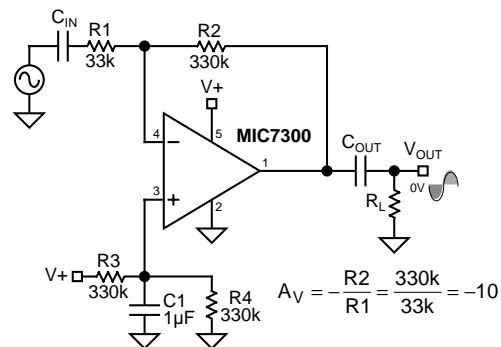
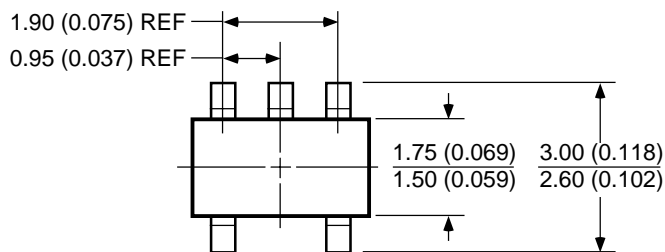
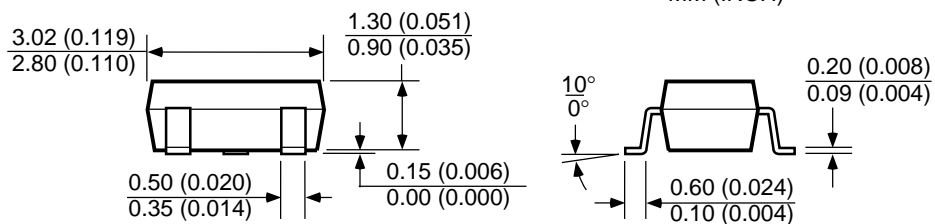

Figure 7. AC-Coupled Inverting Amplifier

Package Information



DIMENSIONS:
MM (INCH)



SOT-23-5 (M5)

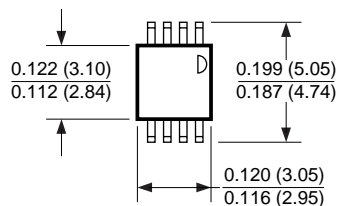

DIMENSIONS:
INCH (MM)

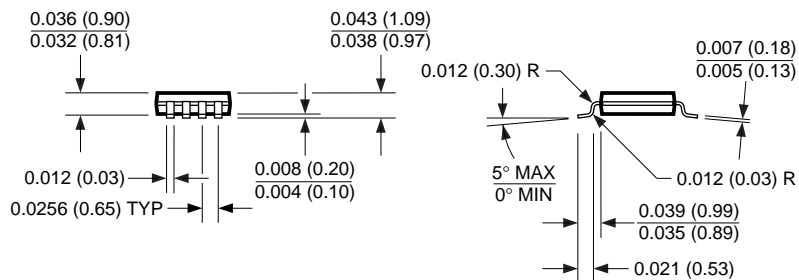

8-Pin MSOP (MM)

MICREL INC. 2180 FORTUNE DRIVE SAN JOSE, CA 95131 USA

TEL + 1 (408) 944-0800 FAX + 1 (408) 474-1000 WEB <http://www.micrel.com>

This information is believed to be accurate and reliable, however no responsibility is assumed by Micrel for its use nor for any infringement of patents or other rights of third parties resulting from its use. No license is granted by implication or otherwise under any patent or patent right of Micrel Inc.

© 2005 Micrel Incorporated