

### Main product characteristics

$I_{F(AV)}$	2 x 5 A
$V_{RRM}$	60 V
$T_j(max)$	150° C
$V_F(max)$	0.52 V

### Features and benefits

- Low forward voltage drop
- Negligible switching losses
- Insulated package: TO-220FPAB  
Insulating voltage = 2000 V DC  
Capacitance = 12 pF
- Avalanche capability specified

### Description

Dual center tap Schottky rectifier suited for switch mode power supplies and high frequency DC to DC converters.

Packaged in TO-220FPAB and D<sup>2</sup>PAK, this device is intended for use in high frequency inverters.

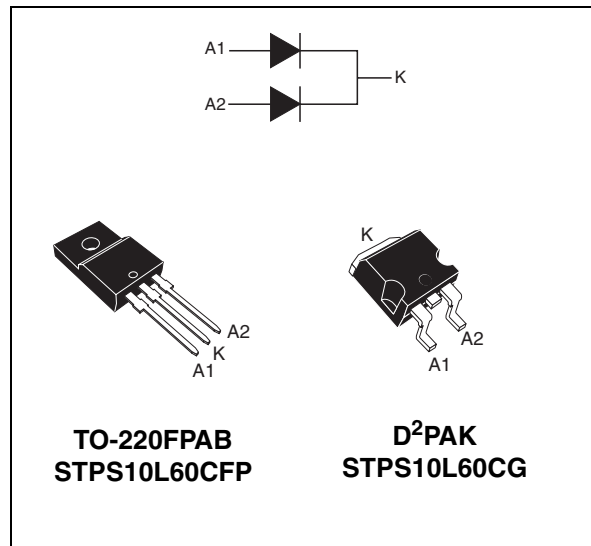

# 1 Characteristics

Symbol	Parameter			Value	Unit	
V <sub>RRM</sub>	Repetitive peak reverse voltage			60	V	
I <sub>F(RMS)</sub>	RMS forward current			30	A	
I <sub>F(AV)</sub>	Average forward current	TO220FPAB	T <sub>C</sub> = 130° C δ = 0.5	Per diode Per device	5 10	A
I <sub>FSM</sub>	Surge non repetitive forward current		tp = 10 ms Sinusoidal		180	A
I <sub>RRM</sub>	Repetitive peak reverse current		tp = 2 μs square F=1 kHz		1	A
P <sub>ARM</sub>	Repetitive peak avalanche power		tp = 1 μs T <sub>j</sub> = 25° C		4000	W
T <sub>stg</sub>	Storage temperature range			-65 to +175	° C	
T <sub>j</sub>	Maximum operating junction temperature <sup>(1)</sup>			150	° C	
dV/dt	Critical rate of rise reverse voltage			10000	V/μs	

1.  $\frac{dP_{Tot}}{dT_j} < \frac{1}{R_{th(j-a)}}$  thermal runaway condition for a diode on its own heatsink

**Table 1. Thermal resistance**

Symbol	Parameter		Value	Unit
R <sub>th(j-c)</sub>	Junction to case	Per diode	4.5	° C/W
	TO-220FPAB	Total	3.5	
R <sub>th(c)</sub>	Coupling		2.5	° C/W

When the diodes 1 and 2 are used simultaneously :

$$\Delta T_j(\text{diode } 1) = P(\text{diode } 1) \times R_{th(j-c)}(\text{Per diode}) + P(\text{diode } 2) \times R_{th(c)}$$

**Table 2. Static electrical characteristics (per diode)**

Symbol	Parameter	Tests Conditions		Min.	Typ.	Max.	Unit
I <sub>R</sub> <sup>(1)</sup>	Reverse leakage current	T <sub>j</sub> = 25° C	V <sub>R</sub> = V <sub>RRM</sub>			220	μA
		T <sub>j</sub> = 125° C			45	60	mA
V <sub>F</sub> <sup>(1)</sup>	Forward voltage drop	T <sub>j</sub> = 25° C	I <sub>F</sub> = 5 A			0.55	V
		T <sub>j</sub> = 125° C	I <sub>F</sub> = 5 A		0.43	0.52	
		T <sub>j</sub> = 25° C	I <sub>F</sub> = 10 A			0.67	
		T <sub>j</sub> = 125° C	I <sub>F</sub> = 10 A		0.55	0.64	

1. Pulse test : tp = 380 μs, δ < 2%

To evaluate the conduction losses use the following equation:

$$P = 0.44 \times I_{F(AV)} + 0.0091 \times I_{F(RMS)}^2$$

**Figure 1. Average forward power dissipation versus average forward current (per diode)**

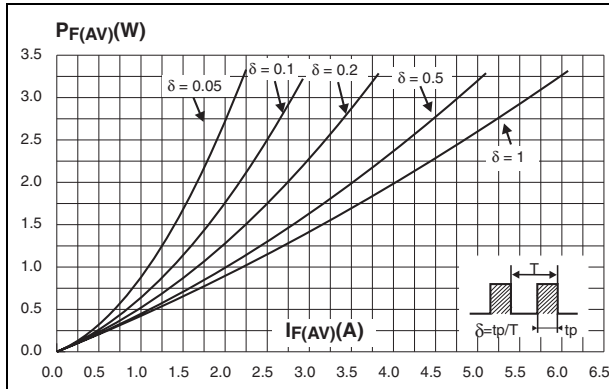

**Figure 2. Average forward current versus ambient temperature ( $\delta = 0.5$ ) (per diode)**

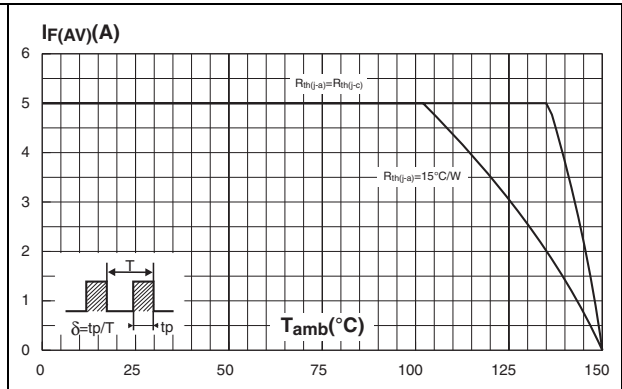

**Figure 3. Normalized avalanche power derating versus pulse duration**

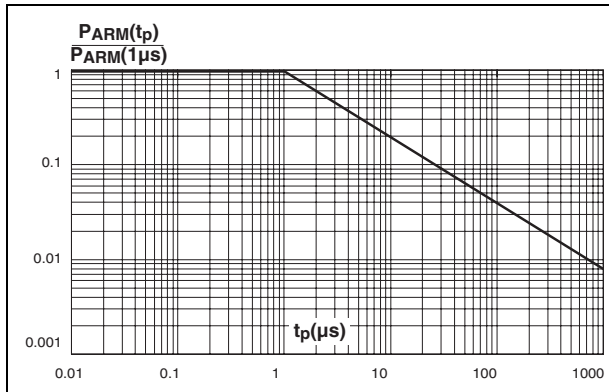

**Figure 4. Normalized avalanche power derating versus junction temperature**

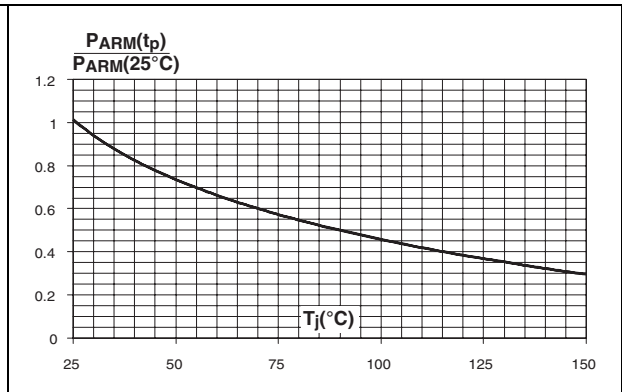

**Figure 5. Non repetitive surge peak forward current versus overload duration (maximum values, per diode) (TO-220FPAB)**

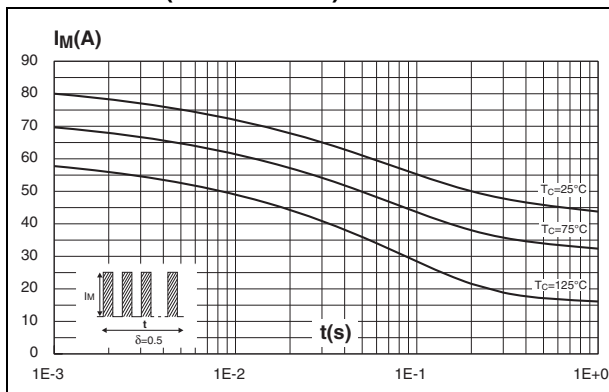

**Figure 6. Relative variation of thermal transient impedance junction to case versus pulse duration (TO-220FPAB)**

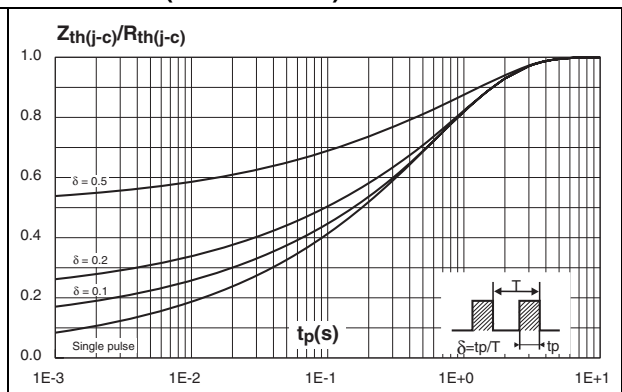

**Figure 7. Relative variation of thermal transient impedance junction to case versus pulse duration (D<sup>2</sup>PAK)**

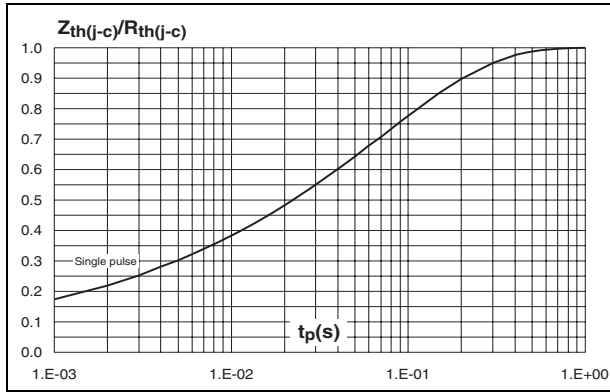

**Figure 8. Reverse leakage current versus reverse voltage applied (typical values, per diode)**

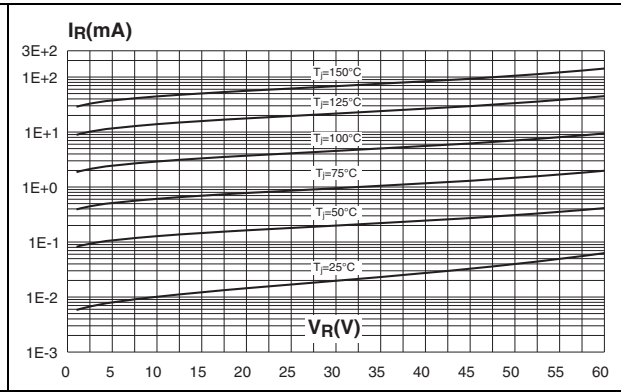

**Figure 9. Junction capacitance versus reverse voltage applied (typical values, per diode)**

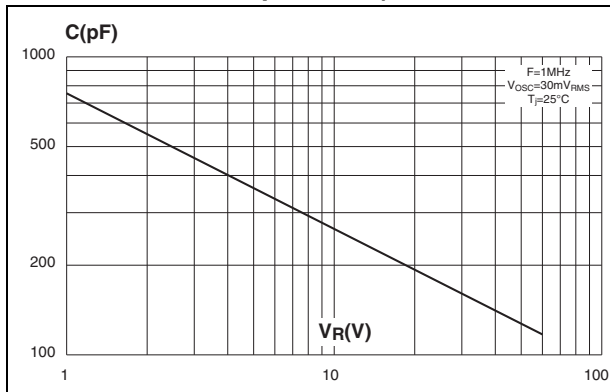

**Figure 10. Forward voltage drop versus forward current (maximum values, per diode)**

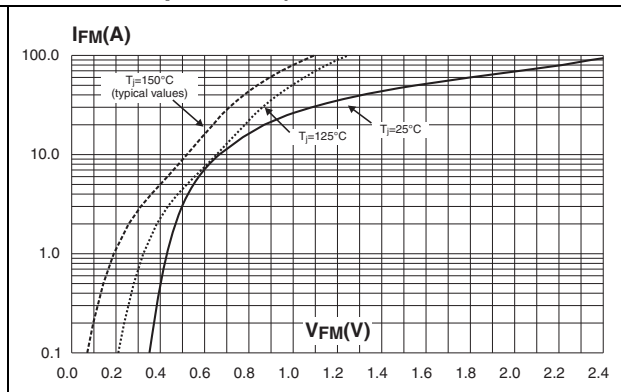

**Figure 11. Thermal resistance junction to ambient versus copper surface under tab (Epoxy printed circuit board FR4, copper thickness: 35  $\mu\text{m}$ ) (D<sup>2</sup>PAK)**

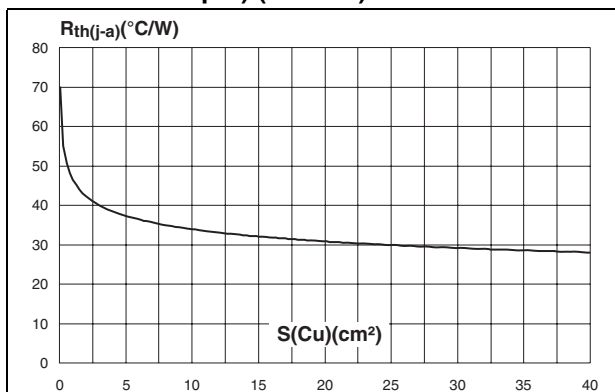

## 2 Package information

- Epoxy meets UL94, V0
- Cooling method: by conduction (C)
- Recommended torque value: 0.55 Nm
- Maximum torque value: 0.70 Nm

**Table 3. TO-220FPAB dimensions**

REF.	Dimensions			
	Millimeters		Inches	
	Min.	Max.	Min.	Max.
A	4.40	4.60	0.173	0.181
B	2.50	2.70	0.098	0.106
D	2.50	2.75	0.098	0.108
E	0.45	0.70	0.018	0.027
F	0.75	1.00	0.030	0.039
F1	1.15	1.70	0.045	0.067
F2	1.15	1.70	0.045	0.067
G	4.95	5.20	0.195	0.205
G1	2.40	2.70	0.094	0.106
H	10.00	10.40	0.393	0.409
L2	16.00 Typ.		0.630 Typ.	
L3	28.60	30.60	1.126	1.205
L4	9.80	10.60	0.386	0.417
L5	2.9	3.6	0.114	0.142
L6	15.90	16.40	0.626	0.646
L7	9.00	9.30	0.354	0.366
Diam	3.00	3.20	0.118	0.126

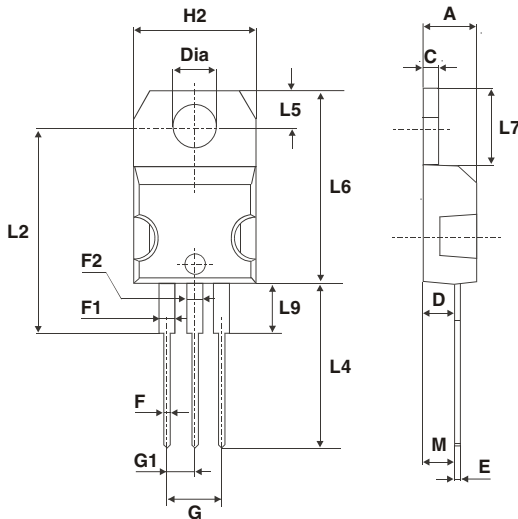
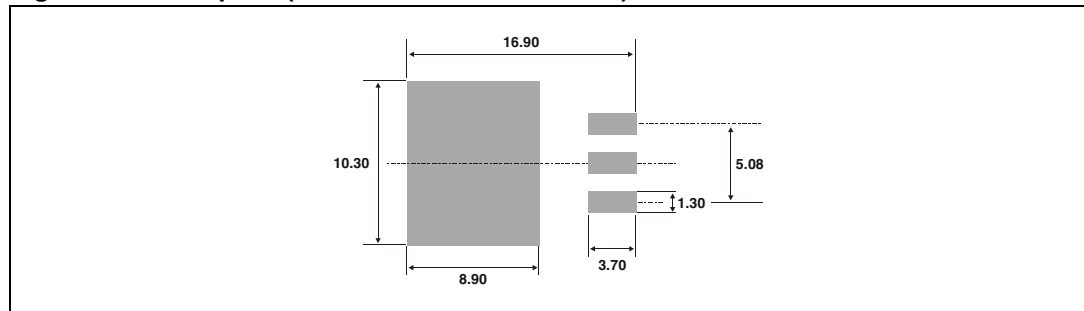

Table 4. D<sup>2</sup>PAK dimensions

Ref	Dimensions			
	Millimeters		Inches	
	Min.	Max.	Min.	Max.
A	4.40	4.60	0.173	0.181
A1	2.49	2.69	0.098	0.106
A2	0.03	0.23	0.001	0.009
B	0.70	0.93	0.027	0.037
B2	1.14	1.70	0.045	0.067
C	0.45	0.60	0.017	0.024
C2	1.23	1.36	0.048	0.054
D	8.95	9.35	0.352	0.368
E	10.00	10.40	0.393	0.409
G	4.88	5.28	0.192	0.208
L	15.00	15.85	0.590	0.624
L2	1.27	1.40	0.050	0.055
L3	1.40	1.75	0.055	0.069
M	2.40	3.20	0.094	0.126
R	0.40 typ.		0.016 typ.	
V2	0°	8°	0°	8°

Figure 12. Footprint (dimensions in millimeters)



In order to meet environmental requirements, ST offers these devices in ECOPACK® packages. These packages have a lead-free second level interconnect. The category of second level interconnect is marked on the package and on the inner box label, in compliance with JEDEC Standard JESD97. The maximum ratings related to soldering conditions are also marked on the inner box label. ECOPACK is an ST trademark. ECOPACK specifications are available at: [www.st.com](http://www.st.com).

### 3 Ordering information

Type	Marking	Package	Weight	Base qty	Delivery mode
STPS10L60CFP	STPS10L60CFP	TO-220FPAB	2 g	50	Tube
STPS10L60CG	STPS10L60CG	D <sup>2</sup> PAK	1.48 g	50	Tube
STPS10L60CG-TR	STPS10L60CG	D <sup>2</sup> PAK	1.48 g	1000	Tape and reel

### 4 Revision history

Date	Revision	Description of Changes
Jul-2003	3C	Last release.
26-Mar-2007	4	Removed ISOWATT package. Added D <sup>2</sup> PAK package.

**Please Read Carefully:**

Information in this document is provided solely in connection with ST products. STMicroelectronics NV and its subsidiaries ("ST") reserve the right to make changes, corrections, modifications or improvements, to this document, and the products and services described herein at any time, without notice.

All ST products are sold pursuant to ST's terms and conditions of sale.

Purchasers are solely responsible for the choice, selection and use of the ST products and services described herein, and ST assumes no liability whatsoever relating to the choice, selection or use of the ST products and services described herein.

No license, express or implied, by estoppel or otherwise, to any intellectual property rights is granted under this document. If any part of this document refers to any third party products or services it shall not be deemed a license grant by ST for the use of such third party products or services, or any intellectual property contained therein or considered as a warranty covering the use in any manner whatsoever of such third party products or services or any intellectual property contained therein.

**UNLESS OTHERWISE SET FORTH IN ST'S TERMS AND CONDITIONS OF SALE ST DISCLAIMS ANY EXPRESS OR IMPLIED WARRANTY WITH RESPECT TO THE USE AND/OR SALE OF ST PRODUCTS INCLUDING WITHOUT LIMITATION IMPLIED WARRANTIES OF MERCHANTABILITY, FITNESS FOR A PARTICULAR PURPOSE (AND THEIR EQUIVALENTS UNDER THE LAWS OF ANY JURISDICTION), OR INFRINGEMENT OF ANY PATENT, COPYRIGHT OR OTHER INTELLECTUAL PROPERTY RIGHT.**

**UNLESS EXPRESSLY APPROVED IN WRITING BY AN AUTHORIZED ST REPRESENTATIVE, ST PRODUCTS ARE NOT RECOMMENDED, AUTHORIZED OR WARRANTED FOR USE IN MILITARY, AIR CRAFT, SPACE, LIFE SAVING, OR LIFE SUSTAINING APPLICATIONS, NOR IN PRODUCTS OR SYSTEMS WHERE FAILURE OR MALFUNCTION MAY RESULT IN PERSONAL INJURY, DEATH, OR SEVERE PROPERTY OR ENVIRONMENTAL DAMAGE. ST PRODUCTS WHICH ARE NOT SPECIFIED AS "AUTOMOTIVE GRADE" MAY ONLY BE USED IN AUTOMOTIVE APPLICATIONS AT USER'S OWN RISK.**

Resale of ST products with provisions different from the statements and/or technical features set forth in this document shall immediately void any warranty granted by ST for the ST product or service described herein and shall not create or extend in any manner whatsoever, any liability of ST.

ST and the ST logo are trademarks or registered trademarks of ST in various countries.

Information in this document supersedes and replaces all information previously supplied.

The ST logo is a registered trademark of STMicroelectronics. All other names are the property of their respective owners.

© 2007 STMicroelectronics - All rights reserved

STMicroelectronics group of companies

Australia - Belgium - Brazil - Canada - China - Czech Republic - Finland - France - Germany - Hong Kong - India - Israel - Italy - Japan - Malaysia - Malta - Morocco - Singapore - Spain - Sweden - Switzerland - United Kingdom - United States of America

[www.st.com](http://www.st.com)