

200MHz to 6000MHz Quadrature Modulator with Ultrahigh OIP3

FEATURES

- **Frequency Range: 200MHz to 6000MHz**
- **Output IP3: +31dBm Typical at 2140MHz (Uncalibrated)**
+35dBm Typical (User Optimized)
- **Single Pin Calibration to Optimize OIP3**
- **Low Output Noise Floor at 6MHz Offset:**
No RF: -160.6dBm/Hz
P_{OUT} = 5dBm: -155.5dBm/Hz
- **Integrated LO Buffer and LO Quadrature Phase Generator**
- **High Impedance DC Interface to Baseband Inputs with 0.5V Common Mode Voltage***
- **50Ω Single-Ended LO and RF Ports**
- **3.3V Operation**
- **Fast Turn-Off/On: 10ns/17ns**
- **Temperature Sensor (Thermistor)**
- **24-Lead UTQFN 4mm × 4mm Package**

APPLICATIONS

- LTE, GSM/EDGE, W-CDMA, TD-SCDMA, CDMA2K, WiMax Basestations
- Image Reject Upconverters
- Point-to-Point Microwave Links
- Broadcast Modulator
- Military Radio

DESCRIPTION

The LTC[®]5588-1 is a direct conversion I/Q modulator designed for high performance wireless applications. It allows direct modulation of an RF signal using differential baseband I and Q signals. It supports LTE, GSM, EDGE, TD-SCDMA, CDMA, CDMA2000, W-CDMA, WiMax and other communication standards. It can also be configured as an image reject upconverting mixer, by applying 90° phase-shifted signals to the I and Q inputs. The I/Q baseband inputs drive double-balanced mixers. An on-chip balun converts the differential mixer signals to a 50Ω single-ended RF output. Four balanced I and Q baseband input ports are DC-coupled with a common mode voltage level of 0.5V. The LO path consists of an LO buffer with single-ended or differential inputs and precision quadrature generators to drive the mixers. The supply voltage range is 3.15V to 3.45V. An external voltage can be applied to the LINOPT pin to further improve 3rd-order linearity performance. Accurate temperature dependent calibrations can be performed using the on-chip thermistor.

LT, LT, LTC, LTM, Linear Technology and the Linear logo are registered trademarks of Linear Technology Corporation. All other trademarks are the property of their respective owners.

*Contact LTC Marketing for other common mode voltage versions.

TYPICAL APPLICATION

200MHz to 6000MHz Direct Conversion Transmitter Application

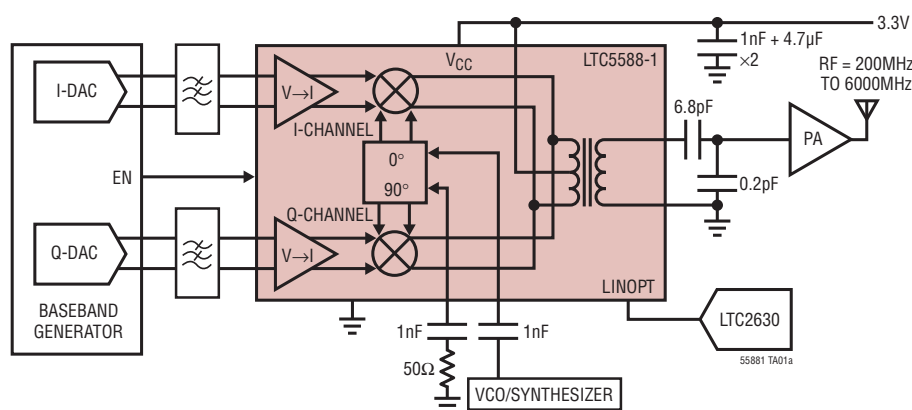

ACPR, AItCPR and ACPR, AItCPR with Optimized LINOPT Voltage vs RF Output Power at 2.14GHz for W-CDMA 1, 2 and 4 Carriers

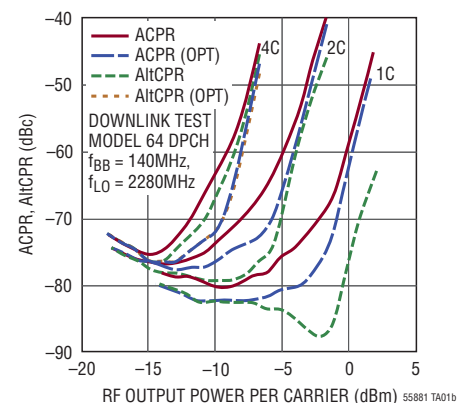

55881fb

ABSOLUTE MAXIMUM RATINGS

(Note 1)

Supply Voltage.....	3.8V
Common Mode Level of BBPI, BBMI, and BBPQ, BBMQ.....	0.55V
Voltage on Any Pin.....	-0.3V to $V_{CC} + 0.3V$
T_{JMAX}	150°C
Operating Temperature Range	-40°C to 85°C
Storage Temperature Range	-65°C to 150°C

PIN CONFIGURATION

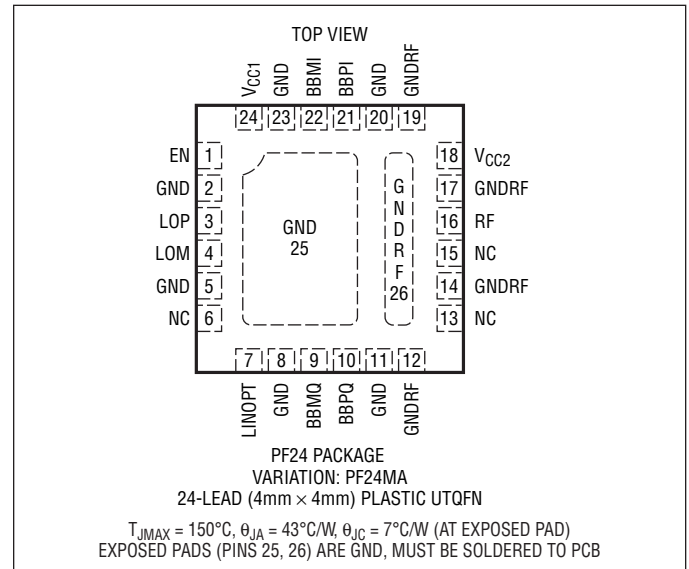

ORDER INFORMATION

LEAD FREE FINISH	TAPE AND REEL	PART MARKING	PACKAGE DESCRIPTION	TEMPERATURE RANGE
LTC5588IPF-1#PBF	LTC5588IPF-1#TRPBF	5881T	24-Lead (4mm x 4mm) Plastic UTQFN	-40°C to 85°C

Consult LTC Marketing for parts specified with wider operating temperature ranges.

Consult LTC Marketing for information on non-standard lead based finish parts.

For more information on lead free part marking, go to: <http://www.linear.com/leadfree/>

For more information on tape and reel specifications, go to: <http://www.linear.com/tapeandreel/>

ELECTRICAL CHARACTERISTICS $V_{CC} = 3.3V$, $EN = 3.3V$, $T_A = 25^\circ C$, LOP AC-terminated with 50Ω to ground, BBPI, BBMI, BBPQ, BBMQ common mode DC voltage $V_{CMBB} = 0.5V_{DC}$, I and Q baseband input signal = 100kHz CW, $1V_{P-P(DIFF)}$ each, I and Q 90° shifted, lower sideband selection, LINOPT pin floating, unless otherwise noted. Test circuit is shown in Figure 8.

SYMBOL	PARAMETER	CONDITIONS	MIN	TYP	MAX	UNITS
$f_{LO} = 240MHz$, $f_{RF} = 239.9MHz$, $P_{LO} = 10dBm$, $C7 = 4.7nH$, $C8 = 33pF$, Using U2 = Anaren P/N B0310J50100A00 Balun						
$f_{RF(MATCH)}$	RF Match Frequency Range	S22 < -10dB (Note 10)		200 to 244		MHz
$f_{LO(MATCH)}$	LO Match Frequency Range	S11 < -10dB		200 to 1500		MHz
G_V	Conversion Voltage Gain	$20 \cdot \log(V_{RF(OUT)(50\Omega)} / V_{IN(DIFF)}(I \text{ or } Q))$		-5.9		dB
P_{OUT}	Absolute Output Power	$1V_{P-P(DIFF)}$ CW Signal, I and Q		-1.9		dBm
OP1dB	Output 1dB Compression			5.1		dBm
OIP2	Output 2nd-Order Intercept	(Notes 4, 5)		77.3		dBm
OIP3	Output 3rd-Order Intercept	(Notes 4, 6)		28		dBm
NFloor	RF Output Noise Floor	No Baseband AC Input Signal (Note 3)		-168.3		dBm/Hz
IR	Image Rejection	(Note 7)		-27		dBc
LOFT	Carrier Leakage (LO Feedthrough)	(Note 7)		-53		dBm

ELECTRICAL CHARACTERISTICS

$V_{CC} = 3.3V$, $EN = 3.3V$, $T_A = 25^\circ C$, LOP AC-terminated with 50Ω to ground, BBPI, BBMI, BBPQ, BBMQ common mode DC voltage $V_{CMBB} = 0.5V_{DC}$, I and Q baseband input signal = 100kHz CW, $1V_{P-P(DIFF)}$ each, I and Q 90° shifted, lower sideband selection, LINOPT pin floating, unless otherwise noted. Test circuit is shown in Figure 8.

SYMBOL	PARAMETER	CONDITIONS	MIN	TYP	MAX	UNITS
$f_{LO} = 450MHz$, $f_{RF} = 449.9MHz$, $P_{LO} = 10dBm$, $C7 = 2.7nH$, $C8 = 10pF$, $U2 = Anaren P/N B0310J50100A00 Balun$						
$f_{RF(MATCH)}$	RF Match Frequency Range	$S_{22} < -10dB$ (Note 10)		350 to 468		MHz
$f_{LO(MATCH)}$	LO Match Frequency Range	$S_{11} < -10dB$		200 to 1500		MHz
G_V	Conversion Voltage Gain	$20 \cdot \log(V_{RF(OUT)(50\Omega)} / V_{IN(DIFF)(I \text{ or } Q)})$		-2.6		dB
P_{OUT}	Absolute Output Power	$1V_{P-P(DIFF)}$ CW Signal, I and Q		1.4		dBm
OP1dB	Output 1dB Compression			8.6		dBm
OIP2	Output 2nd-Order Intercept	(Notes 4, 5)		72		dBm
OIP3	Output 3rd-Order Intercept	(Notes 4, 6)		30		dBm
NFloor	RF Output Noise Floor	No Baseband AC Input Signal (Note 3) $P_{OUT} = 1dBm$ (Note 3)		-165.2 -159.8		dBm/Hz dBm/Hz
IR	Image Rejection	(Note 7)		-53		dBc
LOFT	Carrier Leakage (LO Feedthrough)	(Note 7)		-45		dBm
$f_{LO} = 900MHz$, $f_{RF} = 899.9MHz$, $P_{LOM} = 0dBm$, $C7 = 6.8pF$, $C8 = 0.2pF$						
$f_{RF(MATCH)}$	RF Match Frequency Range	$S_{22} < -10dB$		700 to 5000		MHz
$f_{LO(MATCH)}$	LO Match Frequency Range	$S_{11} < -10dB$		600 to 6000		MHz
G_V	Conversion Voltage Gain	$20 \cdot \log(V_{RF(OUT)(50\Omega)} / V_{IN(DIFF)(I \text{ or } Q)})$		0		dB
P_{OUT}	Absolute Output Power	$1V_{P-P(DIFF)}$ CW Signal, I and Q		4.0		dBm
OP1dB	Output 1dB Compression			12.1		dBm
OIP2	Output 2nd-Order Intercept	(Notes 4, 5)		73.6		dBm
OIP3	Output 3rd-Order Intercept	(Notes 4, 6) Optimized (Notes 4, 6, 11)		31.3 35.1		dBm dBm
NFloor	RF Output Noise Floor	No Baseband AC Input Signal (Note 3) $P_{OUT} = 5dBm$ (Note 3) $P_{LOM} = 10dBm$		-161.6 -155.1		dBm/Hz dBm/Hz
IR	Image Rejection	(Note 7)		-45.5		dBc
LOFT	Carrier Leakage (LO Feedthrough)	(Note 7) $EN = Low$ (Note 7)		-43.1 -68.9		dBm dBm
$f_{LO} = 1900MHz$, $f_{RF} = 1899.9MHz$, $P_{LOM} = 0dBm$, $C7 = 6.8pF$, $C8 = 0.2pF$						
$f_{RF(MATCH)}$	RF Match Frequency Range	$S_{22} < -10dB$		700 to 5000		MHz
$f_{LO(MATCH)}$	LO Match Frequency Range	$S_{11} < -10dB$		600 to 6000		MHz
G_V	Conversion Voltage Gain	$20 \cdot \log(V_{RF(OUT)(50\Omega)} / V_{IN(DIFF)(I \text{ or } Q)})$		0.4		dB
P_{OUT}	Absolute Output Power	$1V_{P-P(DIFF)}$ CW Signal, I and Q		4.4		dBm
OP1dB	Output 1dB Compression			12.4		dBm
OIP2	Output 2nd-Order Intercept	(Notes 4, 5)		58.8		dBm
OIP3	Output 3rd-Order Intercept	(Notes 4, 6) Optimized (Notes 4, 6, 11)		30.3 32.7		dBm dBm
NFloor	RF Output Noise Floor	No Baseband AC Input Signal (Note 3)		-160.6		dBm/Hz
IR	Image Rejection	(Note 7)		-54.4		dBc
LOFT	Carrier Leakage (LO Feedthrough)	(Note 7)		-40.9		dBm

ELECTRICAL CHARACTERISTICS

$V_{CC} = 3.3V$, $EN = 3.3V$, $T_A = 25^\circ C$, LOP AC-terminated with 50Ω to ground, BBPI, BBMI, BBPQ, BBMQ common mode DC voltage $V_{CMBB} = 0.5V_{DC}$, I and Q baseband input signal = 100kHz CW, $1V_{P-P(DIFF)}$ each, I and Q 90° shifted, lower sideband selection, LINOPT pin floating, unless otherwise noted. Test circuit is shown in Figure 8.

SYMBOL	PARAMETER	CONDITIONS	MIN	TYP	MAX	UNITS
$f_{LO} = 2140MHz$, $f_{RF} = 2139.9MHz$, $P_{LOM} = 0dBm$, $C7 = 6.8pF$, $C8 = 0.2pF$						
$f_{RF(MATCH)}$	RF Match Frequency Range	$S_{22} < -10dB$		700 to 5000		MHz
$f_{LO(MATCH)}$	LO Match Frequency Range	$S_{11} < -10dB$		600 to 6000		MHz
G_V	Conversion Voltage Gain	$20 \cdot \text{Log} (V_{RF(OUT)(50\Omega)} / V_{IN(DIFF)(I \text{ or } Q)})$		0.2		dB
P_{OUT}	Absolute Output Power	$1V_{P-P(DIFF)}$ CW Signal, I and Q		4.2		dBm
OP1dB	Output 1dB Compression			12.0		dBm
OIP2	Output 2nd Order Intercept	(Notes 4, 5)		58.5		dBm
OIP3	Output 3rd Order Intercept	(Notes 4, 6) Optimized (Notes 4, 6, 11)		30.9 35.1		dBm dBm
NFloor	RF Output Noise Floor	No Baseband AC Input Signal (Note 3) $P_{OUT} = 5dBm$ (Note 3) $P_{LOM} = 10dBm$		-160.6 -155.5		dBm/Hz dBm/Hz
IR	Image Rejection	(Note 7)		-56.6		dBc
LOFT	Carrier Leakage (LO Feedthrough)	(Note 7)		-39.6		dBm
$f_{LO} = 2600MHz$, $f_{RF} = 2599.9MHz$, $P_{LOM} = 0dBm$, $C7 = 6.8pF$, $C8 = 0.2pF$						
$f_{RF(MATCH)}$	RF Match Frequency Range	$S_{22} < -10dB$		700 to 5000		MHz
$f_{LO(MATCH)}$	LO Match Frequency Range	$S_{11} < -10dB$		600 to 6000		MHz
G_V	Conversion Voltage Gain	$20 \cdot \text{Log} (V_{RF(OUT)(50\Omega)} / V_{IN(DIFF)(I \text{ or } Q)})$		-0.2		dB
P_{OUT}	Absolute Output Power	$1V_{P-P(DIFF)}$ CW Signal, I and Q		3.8		dBm
OP1dB	Output 1dB Compression			11.4		dBm
OIP2	Output 2nd-Order Intercept	(Notes 4, 5)		61.1		dBm
OIP3	Output 3rd-Order Intercept	(Notes 4, 6) Optimized (Notes 4, 6, 11)		29.2 39.5		dBm dBm
NFloor	RF Output Noise Floor	No Baseband AC Input Signal (Note 3)		-160.5		dBm/Hz
IR	Image Rejection	(Note 7)		-48.8		dBc
LOFT	Carrier Leakage (LO Feedthrough)	(Note 7)		-35.5		dBm
$f_{LO} = 3500MHz$, $f_{RF} = 3499.9MHz$, $P_{LOM} = 0dBm$, $C7 = 6.8pF$, $C8 = 0.2pF$						
$f_{RF(MATCH)}$	RF Match Frequency Range	$S_{22} < -10dB$		700 to 5000		MHz
$f_{LO(MATCH)}$	LO Match Frequency Range	$S_{11} < -10dB$		600 to 6000		MHz
G_V	Conversion Voltage Gain	$20 \cdot \text{Log} (V_{RF(OUT)(50\Omega)} / V_{IN(DIFF)(I \text{ or } Q)})$		-1.0		dB
P_{OUT}	Absolute Output Power	$1V_{P-P(DIFF)}$ CW Signal, I and Q		3.0		dBm
OP1dB	Output 1dB Compression			10.5		dBm
OIP2	Output 2nd-Order Intercept	(Notes 4, 5)		67.6		dBm
OIP3	Output 3rd-Order Intercept	(Notes 4, 6) Optimized (Notes 4, 6, 11)		23.5 27.5		dBm dBm
NFloor	RF Output Noise Floor	No Baseband AC Input Signal (Note 3)		-160.1		dBm/Hz
IR	Image Rejection	(Note 7)		-36.8		dBc
LOFT	Carrier Leakage (LO Feedthrough)	(Note 7)		-37.5		dBm
$f_{LO} = 5800MHz$, $f_{RF} = 5799.9MHz$, $P_{LOM} = 0dBm$, $C7 = 6.8pF$, $C8 = 0.2pF$						
$f_{RF(MATCH)}$	RF Match Frequency Range	$S_{22} < -10dB$		700 to 5000		MHz
$f_{LO(MATCH)}$	LO Match Frequency Range	$S_{11} < -10dB$		600 to 6000		MHz
G_V	Conversion Voltage Gain	$20 \cdot \text{Log} (V_{RF(OUT)(50\Omega)} / V_{IN(DIFF)(I \text{ or } Q)})$		-9.1		dB
P_{OUT}	Absolute Output Power	$1V_{P-P(DIFF)}$ CW Signal, I and Q		-5.1		dBm

ELECTRICAL CHARACTERISTICS

$V_{CC} = 3.3V$, $EN = 3.3V$, $T_A = 25^\circ C$, LOP AC-terminated with 50Ω to ground, BBPI, BBMI, BBPQ, BBMQ common mode DC voltage $V_{CMBB} = 0.5V_{DC}$, I and Q baseband input signal = 100kHz CW, $1V_{P-P(DIFF)}$ each, I and Q 90° shifted, lower sideband selection, LINOPT pin floating, unless otherwise noted. Test circuit is shown in Figure 8.

SYMBOL	PARAMETER	CONDITIONS	MIN	TYP	MAX	UNITS
OP1dB	Output 1dB Compression			1.9		dBm
OIP2	Output 2nd-Order Intercept	(Notes 4, 5)		35.4		dBm
OIP3	Output 3rd-Order Intercept	(Notes 4, 6)		17.9		dBm
NFloor	RF Output Noise Floor	No Baseband AC Input Signal (Note 3)		-156.7		dBm/Hz
IR	Image Rejection	(Note 7)		-32.3		dBc
LOFT	Carrier Leakage (LO Feedthrough)	(Note 7)		-30.2		dBm
Baseband Inputs (BBPI, BBMI, BBPQ, BBMQ)						
BW _{BB}	Baseband Bandwidth	-1dB Bandwidth, R _{SOURCE} = 25 Ω , Single Ended		430		MHz
I _{b(BB)}	Baseband Input Current	Single Ended		-136		μA
R _{IN(SE)}	Input Resistance	Single Ended		-3		k Ω
V _{CMBB}	DC Common Mode Voltage	Externally Applied		0.5		V
V _{SWING}	Amplitude Swing	No Hard Clipping, Single Ended		0.86		V _{P-P}
Power Supply (V_{CC1}, V_{CC2})						
V _{CC}	Supply Voltage		3.15	3.3	3.45	V
I _{CC(ON)}	Supply Current	EN = High	275	303	325	mA
I _{CC(OFF)}	Supply Current, Sleep Mode	EN = 0V		33	900	μA
t _{ON}	Turn-On Time	EN = Low to High (Notes 8, 13)		17		ns
t _{OFF}	Turn-Off Time	EN = High to Low (Notes 9, 13)		10		ns
t _{ON(IR)}	Image Rejection Settling	EN = Low to High, <-60dBc (Note 13)		80		ns
t _{ON(LO)}	LO Suppression Settling	EN = Low to High, <-60dBm (Note 13)		85		ns
t _{ON(PHASE)}	Phase Settling	EN = Low to High, Phase < 0.5 $^\circ$, f _{LOM} = f _{RF} = 2.14GHz, Constant Board Temperature		70		ns
V _{LINOPT(ON)}	LINOPT Voltage	Floating LINOPT Pin, EN = High		2.56		V
V _{LINOPT(OFF)}	LINOPT Voltage, Sleep Mode	Floating LINOPT Pin, EN = Low		3.3		V
Enable Pin						
Enable	Input High Voltage Input High Current	EN = High EN = 3.3V	2	80		V nA
Sleep	Input Low Voltage Input Low Current	EN = Low EN = 0V		33	1	V μA
Temperature Sensor (Thermistor) (Note 14)						
R _T	Thermistor Resistance	EN = Low, I _{RT} = 100 μA		1.385		k Ω
	Temperature Slope	EN = Low, I _{RT} = 100 μA		11		$\Omega/^\circ C$

Note 1: Stresses beyond those listed under Absolute Maximum Ratings may cause permanent damage to the device. Exposure to any Absolute Maximum Rating condition for extended periods may affect device reliability and lifetime.

Note 2: The LTC5588-1 is guaranteed functional over the operating temperature range from $-40^\circ C$ to $85^\circ C$.

Note 3: At 6MHz offset from the LO signal frequency. 100nF between BBPI and BBMI, 100nF between BBPQ and BBMQ.

Note 4: Baseband inputs are driven with 4.5MHz and 5.5MHz tones.

Note 5: IM2 is measured at $f_{LO} - 10MHz$.

Note 6: IM3 is measured at $f_{LO} - 3.5MHz$ and $f_{LO} - 6.5MHz$. OIP3 = lowest of $(1.5 \cdot P\{f_{LO}-5.5MHz\} - 0.5 \cdot P\{f_{LO}-6.5MHz\})$ and $(1.5 \cdot P\{f_{LO}-4.5MHz\} - 0.5 \cdot P\{f_{LO}-3.5MHz\})$.

Note 7: Without image or LO feedthrough nulling (unadjusted).

Note 8: RF power is within 10% of final value.

Note 9: RF power is at least 30dB down from its ON state.

Note 10: RF matching center frequency is set below band center frequency in order to align RF passband center frequency with band center frequency.

Note 11: An external voltage is optimally set at the LINOPT pin for best output 3rd-order intercept.

Note 12: I and Q baseband Input signal = 10MHz CW, 0.8V_{P-P, DIFF} each, I and Q 0° shifted.

Note 13: $f_{LOM} = 2.14GHz$, $P_{LOM} = 0dBm$, $f_{BB} = 134MHz$; LO feedthrough and image rejection is nulled during previous EN = high cycles, C5 = C6 = 10pF; C13 = 0; Extra 680 μF capacitors (SANYO 6SEPC680M) from TP1 to ground and TP2 to ground, RF noise filter with 93MHz bandwidth is used.

Note 14: Thermistor performance is guaranteed by Design.

TYPICAL PERFORMANCE CHARACTERISTICS $V_{CC} = 3.3V$, $EN = 3.3V$, $T_A = 25^\circ C$, LOP input AC-terminated with 50Ω to ground, BBPI, BBMI, BBPQ, BBMQ inputs $0.5V_{DC}$, and $1V_{P-P(DIFF)}$, baseband input frequencies = 4.5MHz and 5.5MHz for OIP3 and OIP2, or else baseband input frequency = 100kHz, I and Q 90° shifted, lower sideband selection, LINOPT pin floating, unless otherwise noted. Test circuit is shown in Figure 8.

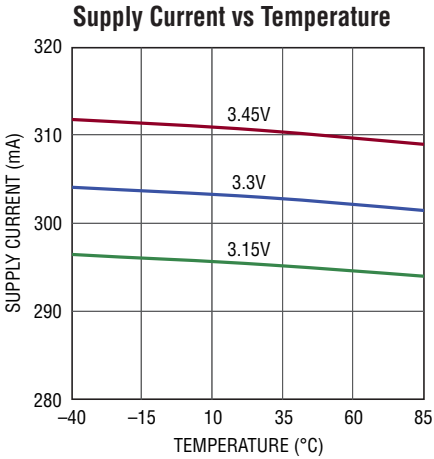

55881 G01

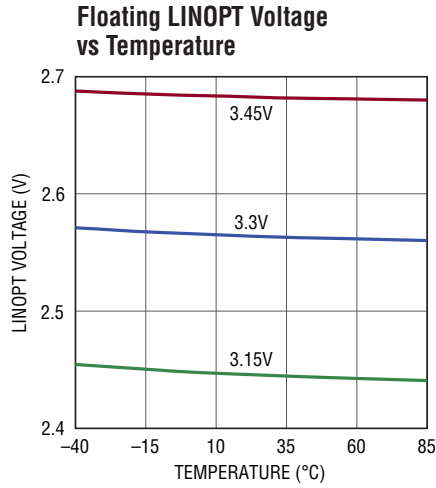

55881 G02

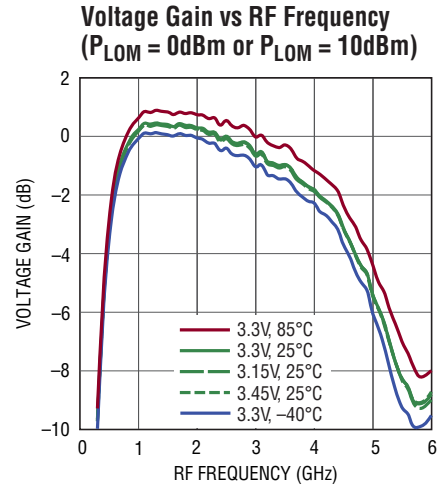

55881 G03

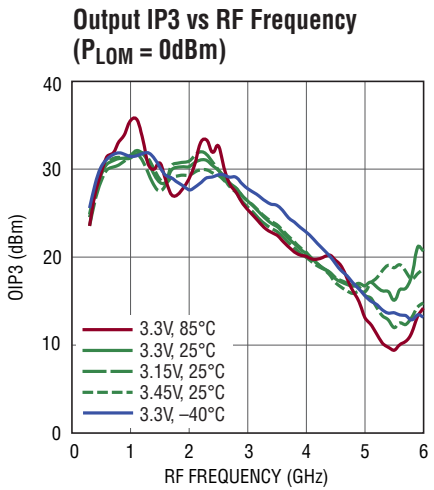

55881 G04

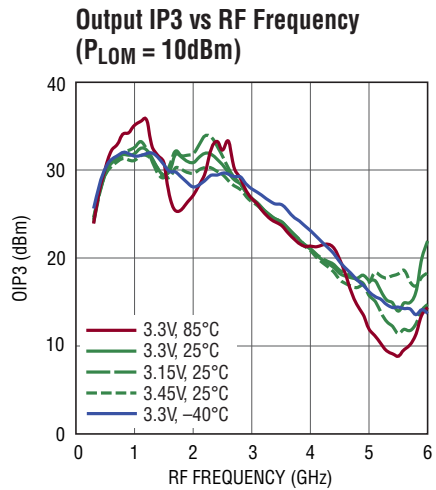

55881 G05

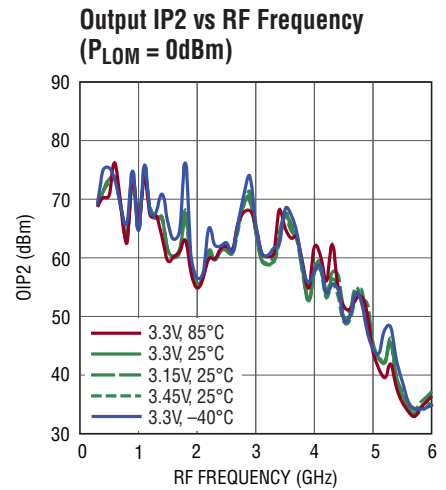

55881 G06

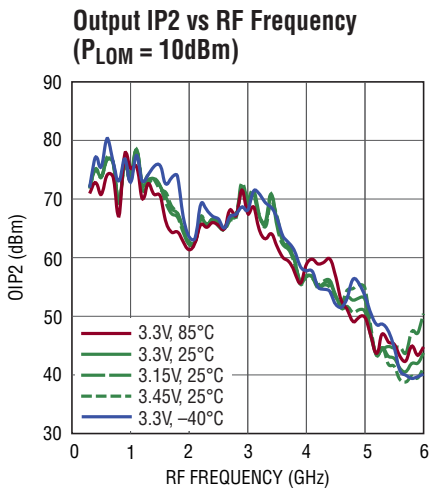

55881 G07

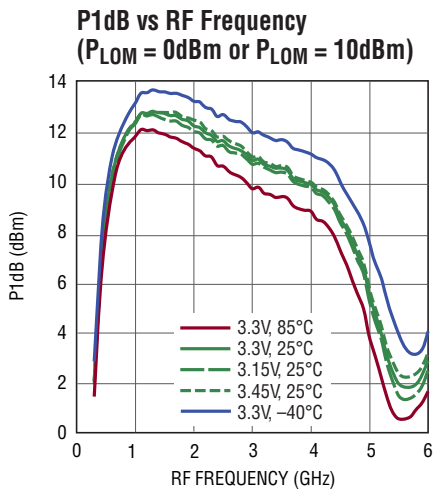

55881 G08

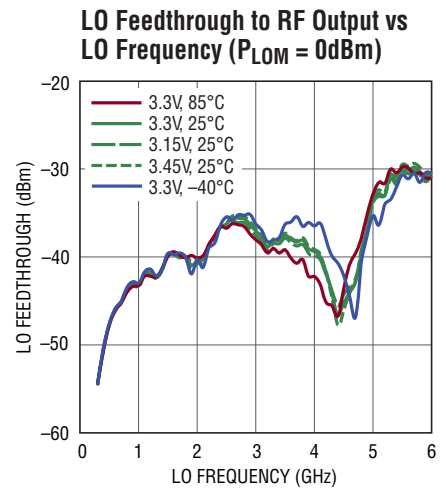

55881 G09

TYPICAL PERFORMANCE CHARACTERISTICS $V_{CC} = 3.3V$, $EN = 3.3V$, $T_A = 25^\circ C$, LOP input AC-terminated with 50Ω to ground, BBPI, BBMI, BBPQ, BBMQ inputs $0.5V_{DC}$, and $1V_{P-P(DIFF)}$, baseband input frequencies = 4.5MHz and 5.5MHz for OIP3 and OIP2, or else baseband input frequency = 100kHz, I and Q 90° shifted, lower sideband selection, LINOPT pin floating, unless otherwise noted. Test circuit is shown in Figure 8.

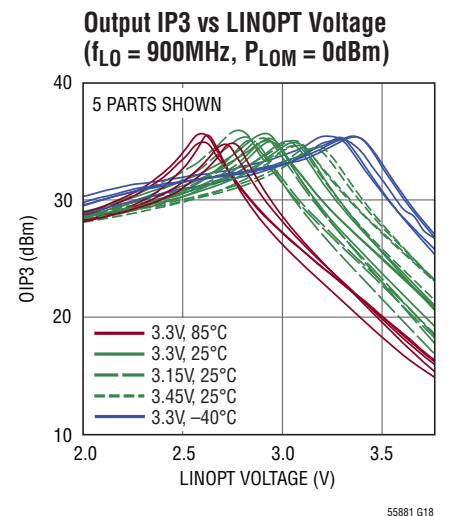
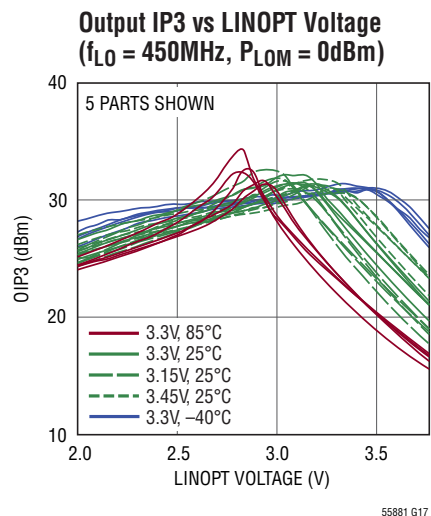
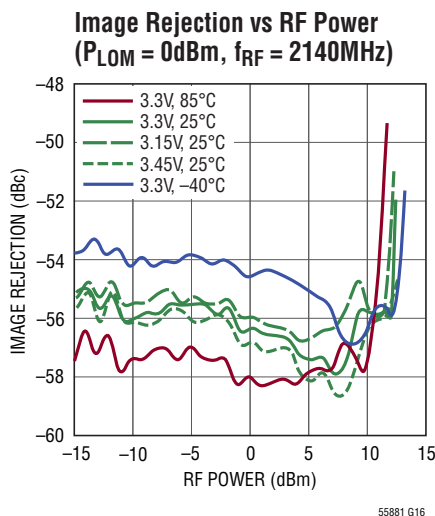
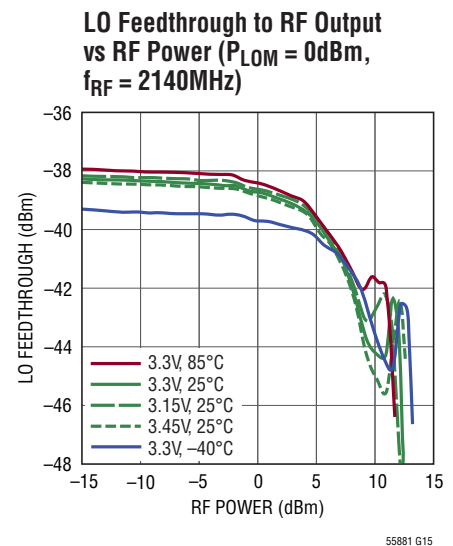
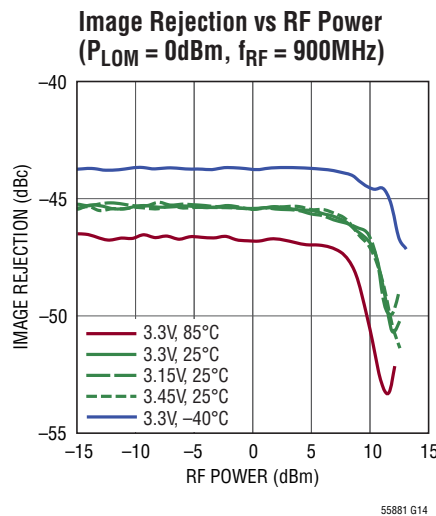
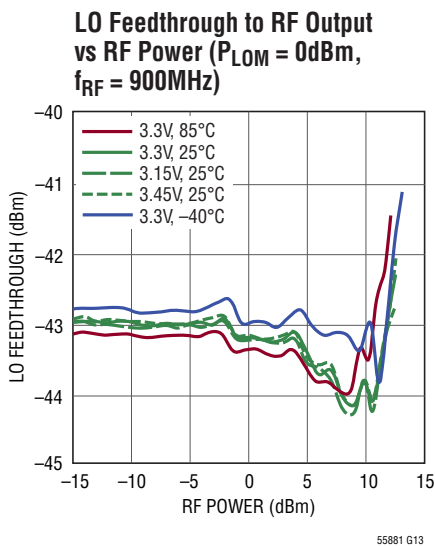
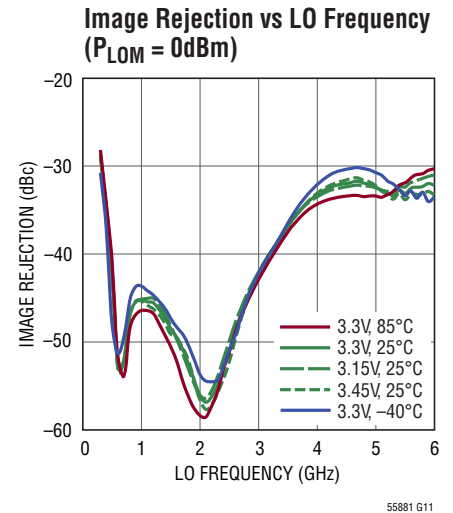
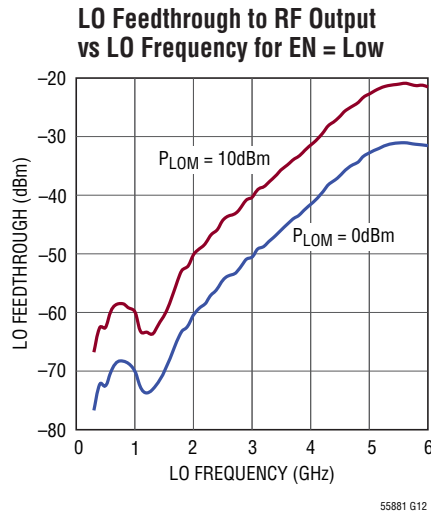
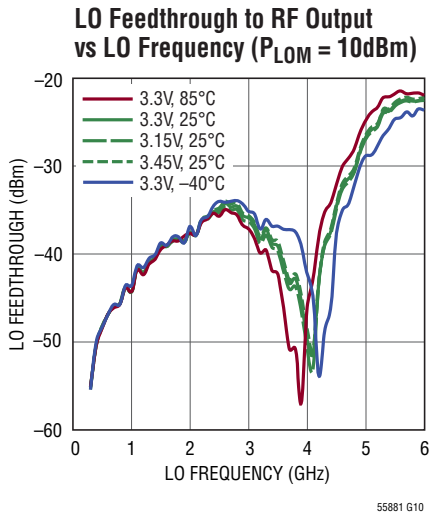

TYPICAL PERFORMANCE CHARACTERISTICS $V_{CC} = 3.3V$, $EN = 3.3V$, $T_A = 25^\circ C$, LOP input AC-terminated with 50Ω to ground, BBPI, BBMI, BBPQ, BBMQ inputs $0.5V_{DC}$, and $1V_{P-P(DIFF)}$, baseband input frequencies = $4.5MHz$ and $5.5MHz$ for OIP3 and OIP2, or else baseband input frequency = $100kHz$, I and Q 90° shifted, lower sideband selection, LINOPT pin floating, unless otherwise noted. Test circuit is shown in Figure 8.

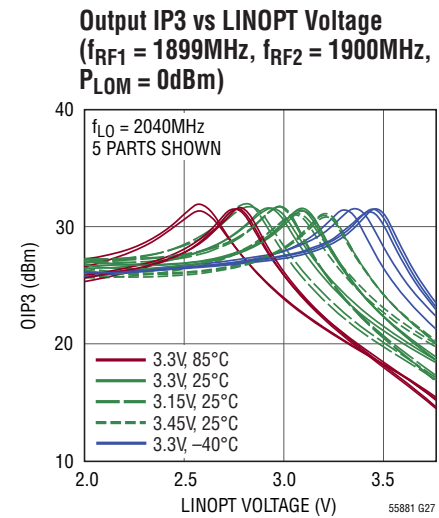
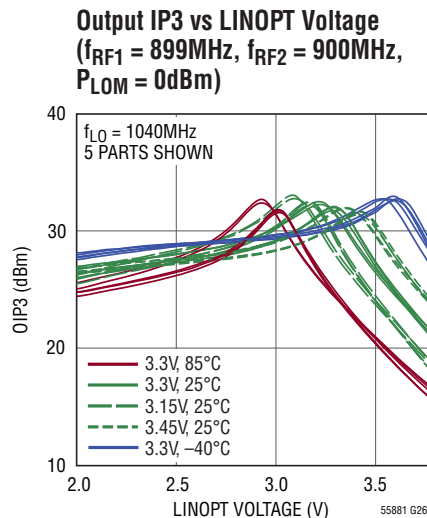
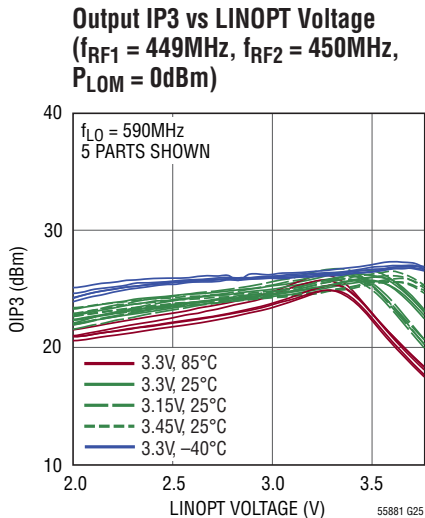
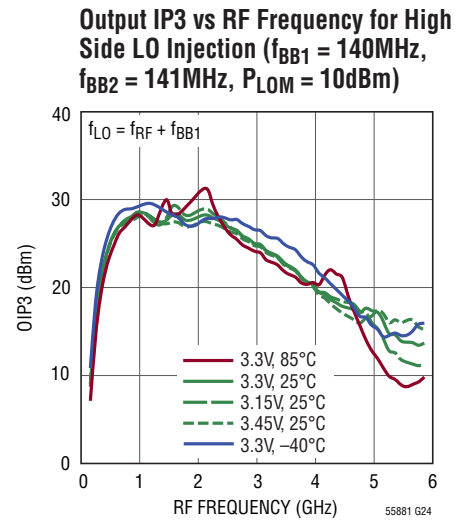
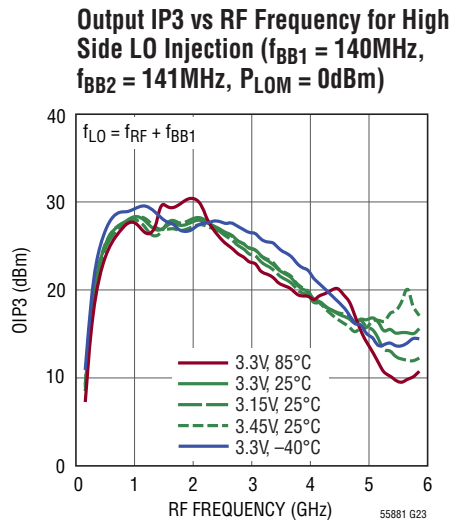
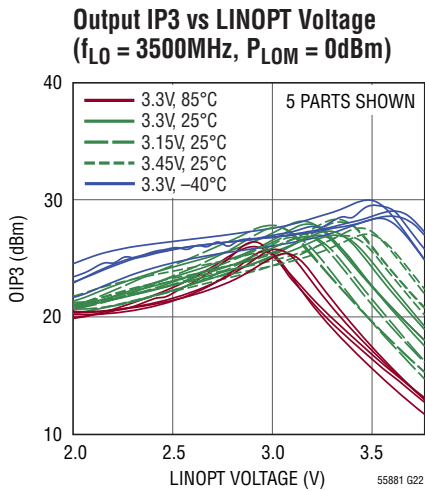
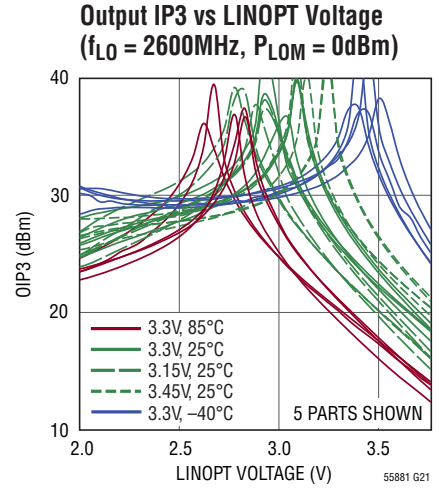
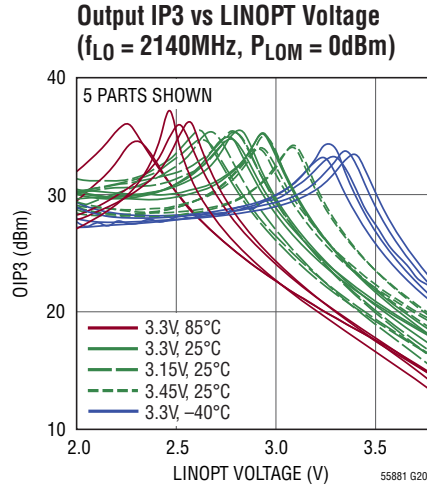
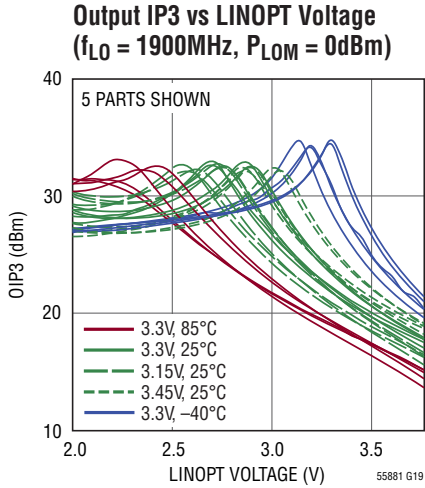

TYPICAL PERFORMANCE CHARACTERISTICS $V_{CC} = 3.3V$, $EN = 3.3V$, $T_A = 25^\circ C$, LOP input AC-terminated with 50Ω to ground, BBPI, BBMI, BBPQ, BBMQ inputs $0.5V_{DC}$, and $1V_{P-P(DIFF)}$, baseband input frequencies = 4.5MHz and 5.5MHz for OIP3 and OIP2, or else baseband input frequency = 100kHz, I and Q 90° shifted, lower sideband selection, LINOPT pin floating, unless otherwise noted. Test circuit is shown in Figure 8.

Output IP3 vs LINOPT Voltage
($f_{RF1} = 2139MHz$, $f_{RF2} = 2140MHz$, $P_{LOM} = 0dBm$)

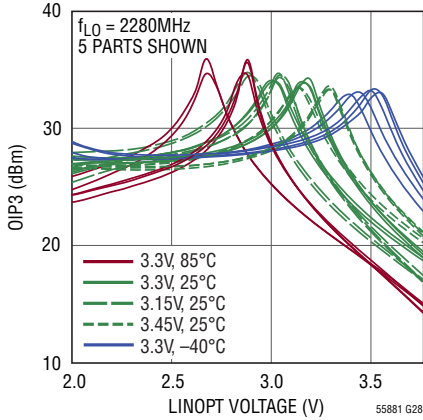

Output IP3 vs LINOPT Voltage
($f_{RF1} = 2599MHz$, $f_{RF2} = 2600MHz$, $P_{LOM} = 0dBm$)

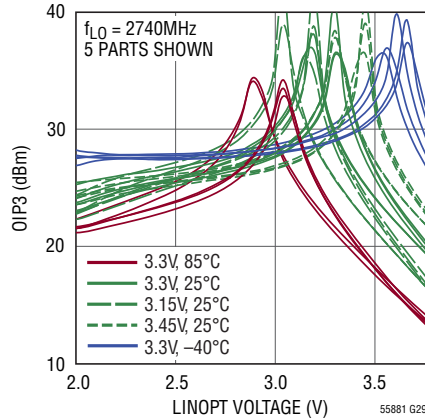

Output IP3 vs LINOPT Voltage
($f_{RF1} = 3499MHz$, $f_{RF2} = 3500MHz$, $P_{LOM} = 0dBm$)

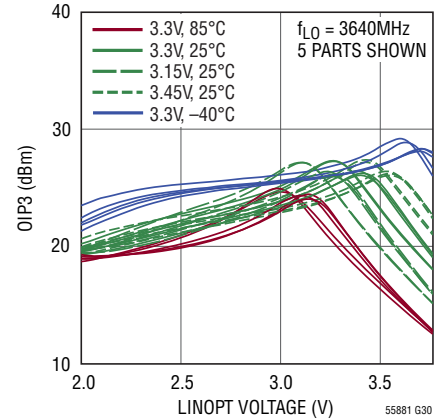

Output IP3 vs RF Frequency for Low Side LO Injection
($f_{BB1} = 140MHz$, $f_{BB2} = 141MHz$, $P_{LOM} = 0dBm$)

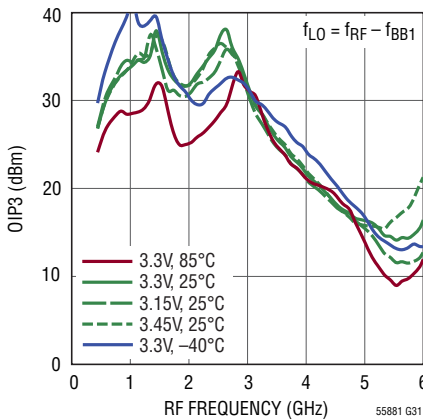

Output IP3 vs RF Frequency for Low Side LO Injection
($f_{BB1} = 140MHz$, $f_{BB2} = 141MHz$, $P_{LOM} = 10dBm$)

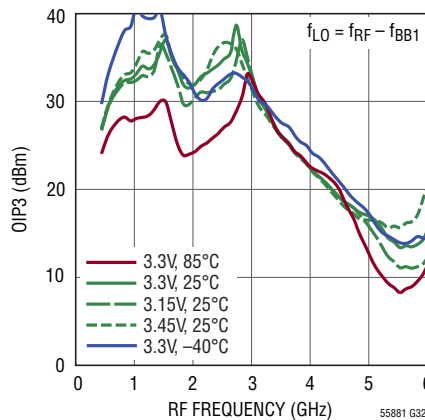

Output IP3 vs LINOPT Voltage
($f_{RF1} = 450MHz$, $f_{RF2} = 451MHz$, $P_{LOM} = 0dBm$)

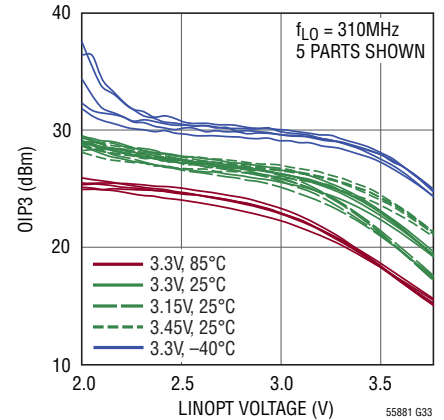

Output IP3 vs LINOPT Voltage
($f_{RF1} = 900MHz$, $f_{RF2} = 901MHz$, $P_{LOM} = 0dBm$)

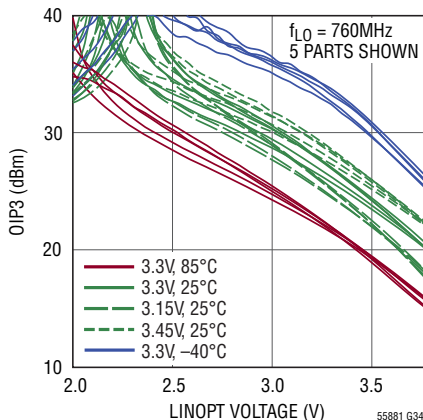

Output IP3 vs LINOPT Voltage
($f_{RF1} = 1900MHz$, $f_{RF2} = 1901MHz$, $P_{LOM} = 0dBm$)

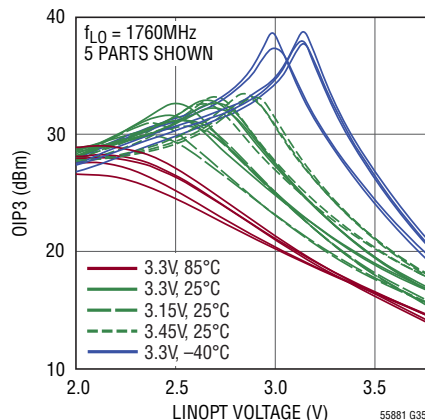

Output IP3 vs LINOPT Voltage
($f_{RF1} = 2140MHz$, $f_{RF2} = 2141MHz$, $P_{LOM} = 0dBm$)

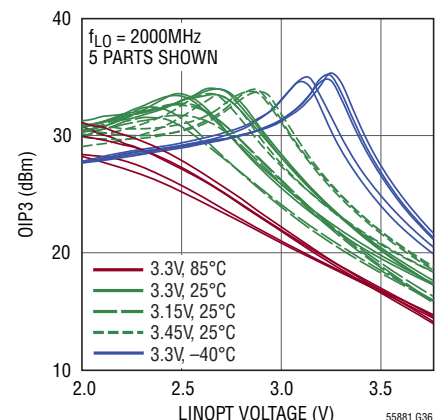

TYPICAL PERFORMANCE CHARACTERISTICS $V_{CC} = 3.3V$, $EN = 3.3V$, $T_A = 25^\circ C$, LOP input AC-terminated with 50Ω to ground, BBPI, BBMI, BBPQ, BBMQ inputs $0.5V_{DC}$, and $1V_{P-P(DIFF)}$, baseband input frequencies = 4.5MHz and 5.5MHz for OIP3 and OIP2, or else baseband input frequency = 100kHz, I and Q 90° shifted, lower sideband selection, LINOPT pin floating, unless otherwise noted. Test circuit is shown in Figure 8.

Output IP3 vs LINOPT Voltage
($f_{RF1} = 2600MHz$, $f_{RF2} = 2601MHz$, $P_{LOM} = 0dBm$)

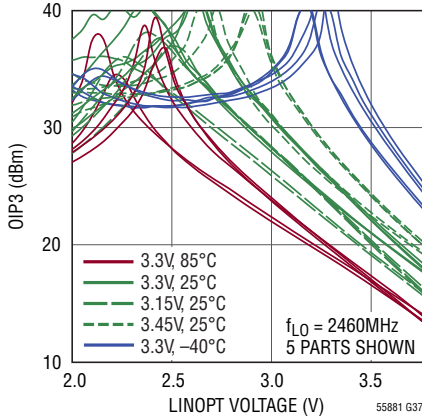

Output IP3 vs LINOPT Voltage
($f_{RF1} = 3500MHz$, $f_{RF2} = 3501MHz$, $P_{LOM} = 0dBm$)

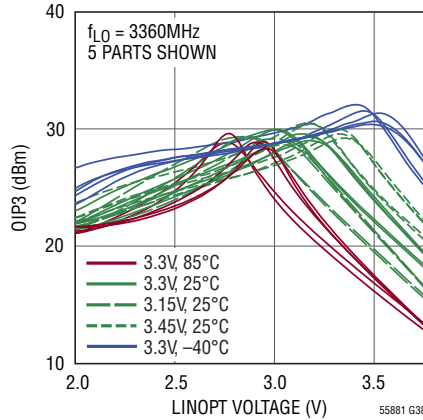

Gain Distribution at 2140MHz

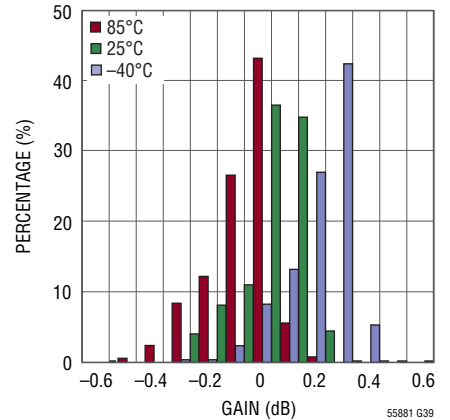

Output IP3 Distribution at 2140MHz

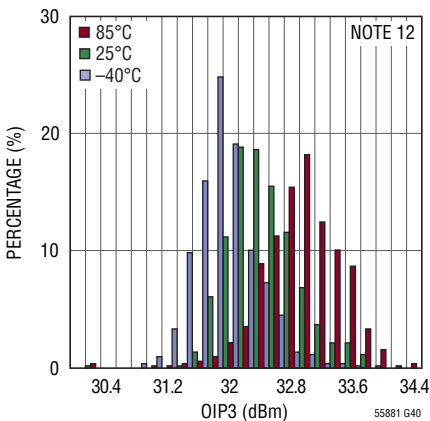

LO Feedthrough Distribution at 2140MHz

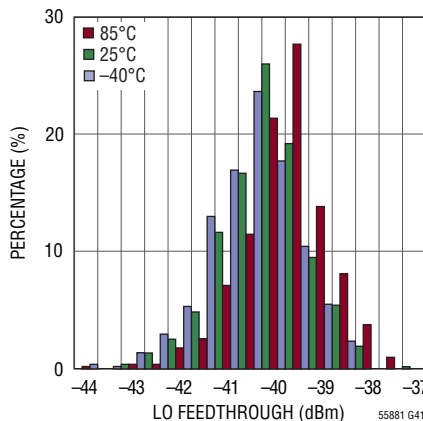
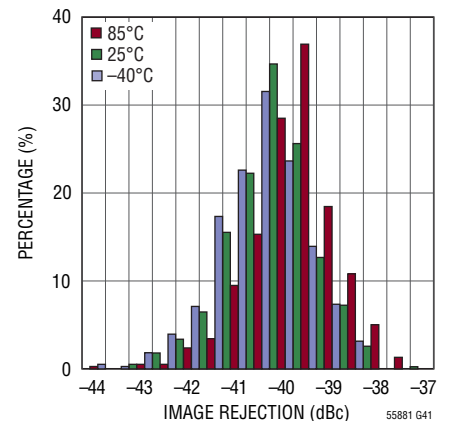
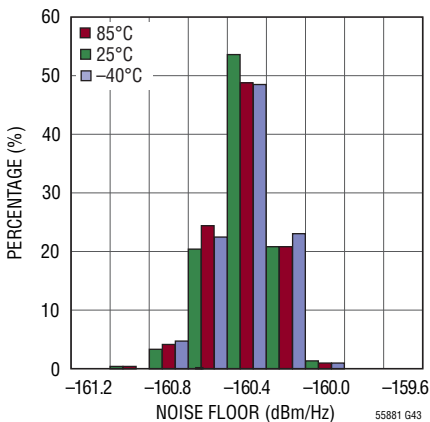

Image Rejection Distribution at 2140MHz



Output Noise Floor Distribution at 2140MHz



Output Noise Floor vs RF Output Power and LOM Port Input Power
($f_{LO} = 2140MHz$)

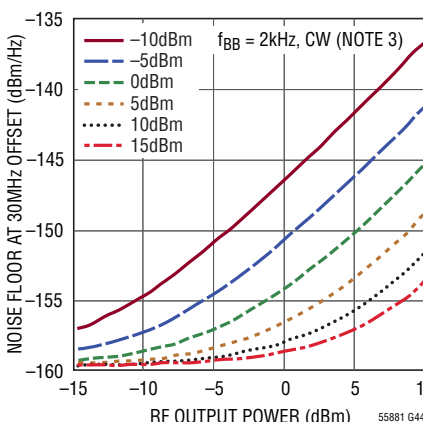

Output Noise Floor vs RF Output Power and Differential LO Input Power
($f_{LO} = 2140MHz$)

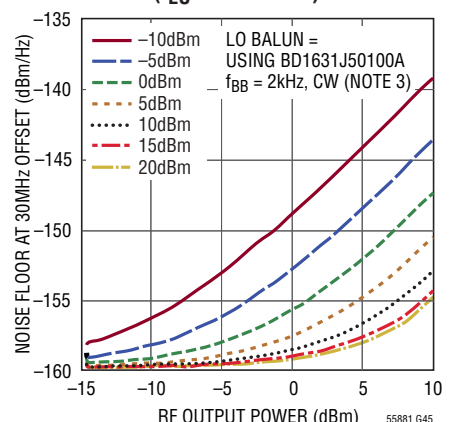

TYPICAL PERFORMANCE CHARACTERISTICS $V_{CC} = 3.3V$, $EN = 3.3V$, $T_A = 25^\circ C$, LOP input AC-terminated with 50Ω to ground, BBPI, BBMI, BBPQ, BBMQ inputs $0.5V_{DC}$, and $1V_{P-P(DIFF)}$, baseband input frequencies = 4.5MHz and 5.5MHz for OIP3 and OIP2, or else baseband input frequency = 100kHz, I and Q 90° shifted, lower sideband selection, LINOPT pin floating, unless otherwise noted. Test circuit is shown in Figure 8.

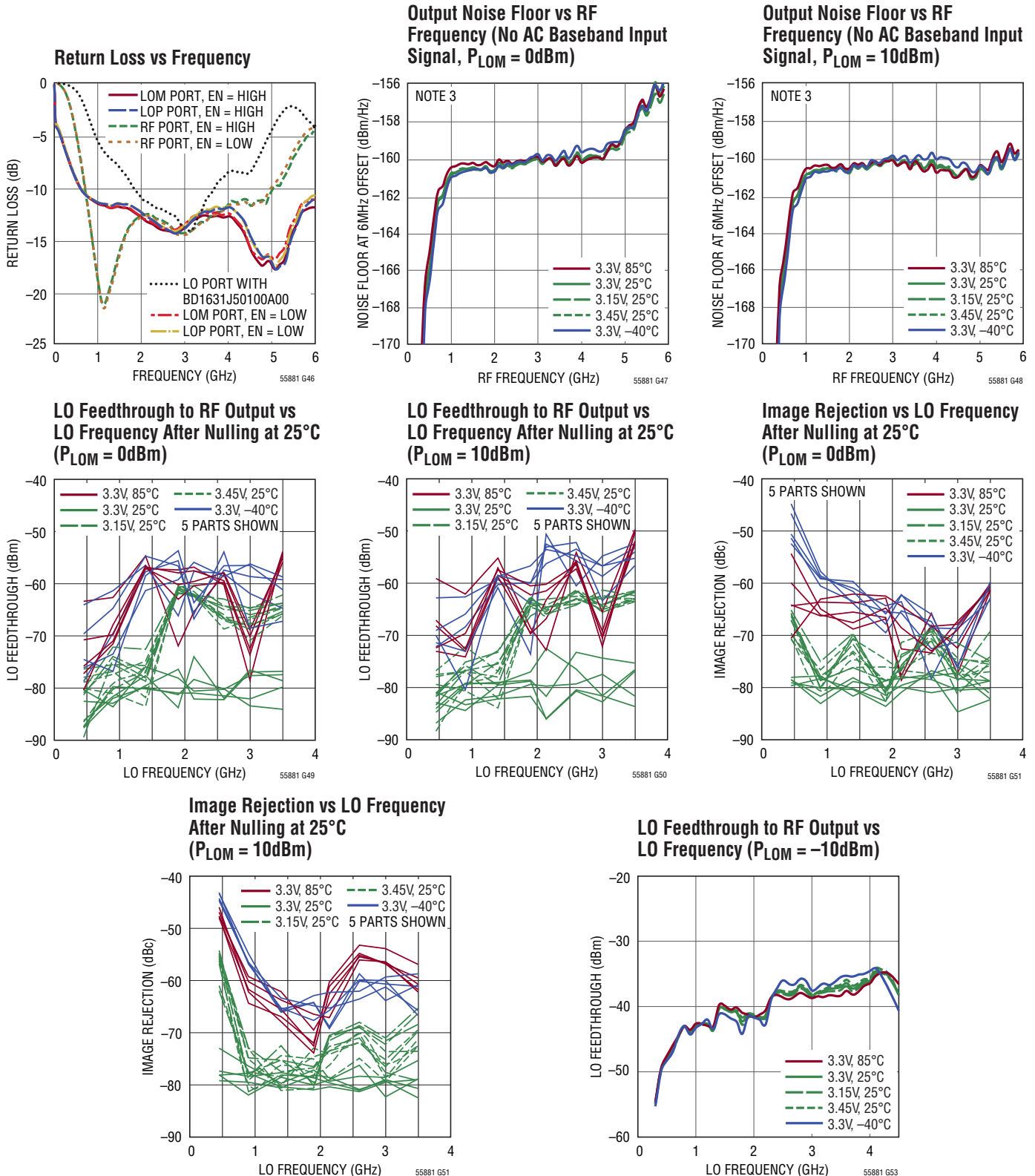

TYPICAL PERFORMANCE CHARACTERISTICS $V_{CC} = 3.3V$, $EN = 3.3V$, $T_A = 25^\circ C$, LOP input AC-terminated with 50Ω to ground, BBPI, BBMI, BBPQ, BBMQ inputs $0.5V_{DC}$, and $1V_{P-P(DIFF)}$, baseband input frequencies = 4.5MHz and 5.5MHz for OIP3 and OIP2, or else baseband input frequency = 100kHz, I and Q 90° shifted, lower sideband selection, LINOPT pin floating, unless otherwise noted. Test circuit is shown in Figure 8.

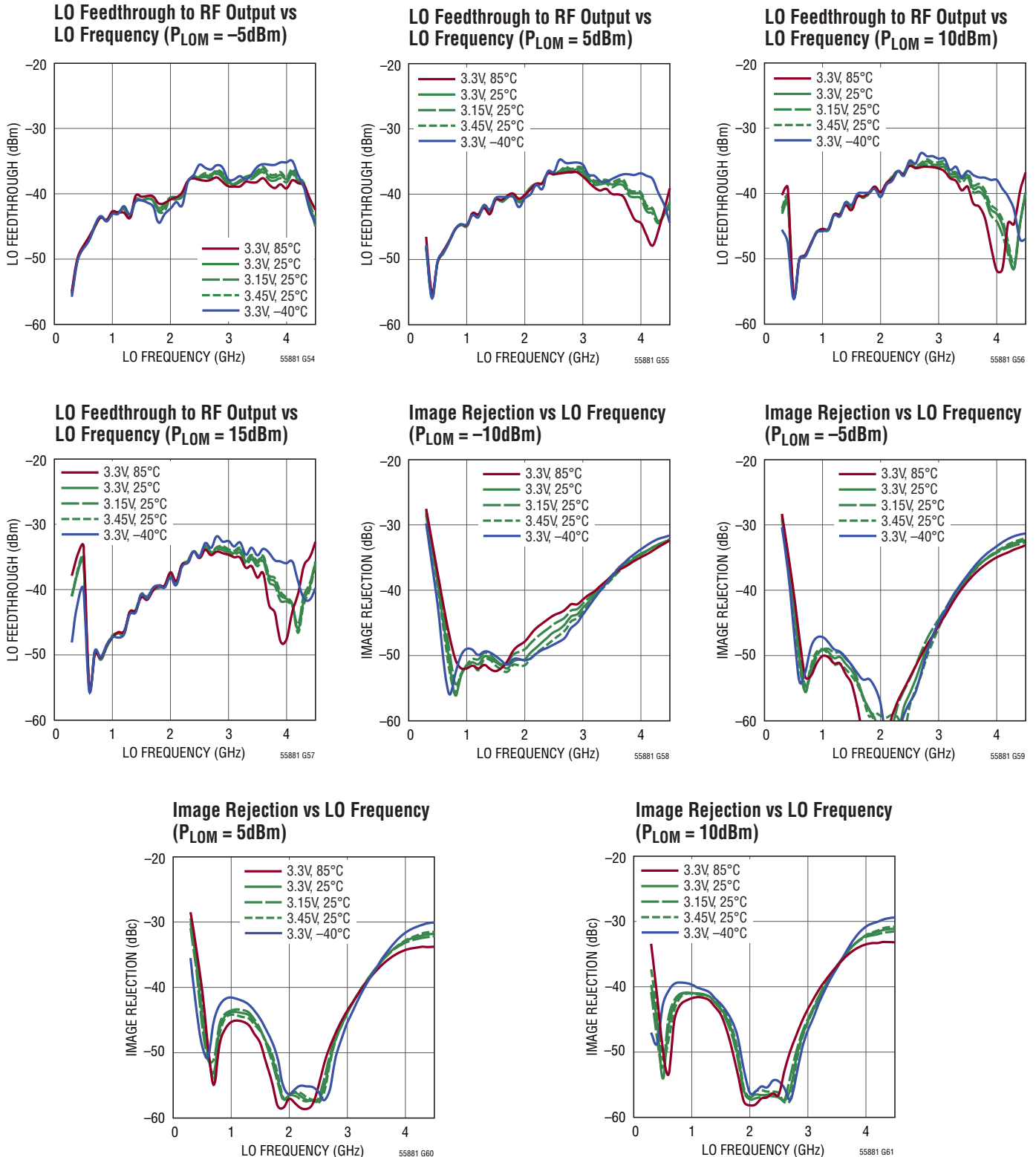

55881fb

TYPICAL PERFORMANCE CHARACTERISTICS $V_{CC} = 3.3V$, $EN = 3.3V$, $T_A = 25^\circ C$, LOP input AC-terminated with 50Ω to ground, BBPI, BBMI, BBPQ, BBMQ inputs $0.5V_{DC}$, and $1V_{P-P(DIFF)}$, baseband input frequencies = 4.5MHz and 5.5MHz for OIP3 and OIP2, or else baseband input frequency = 100kHz, I and Q 90° shifted, lower sideband selection, LINOPT pin floating, unless otherwise noted. Test circuit is shown in Figure 8.

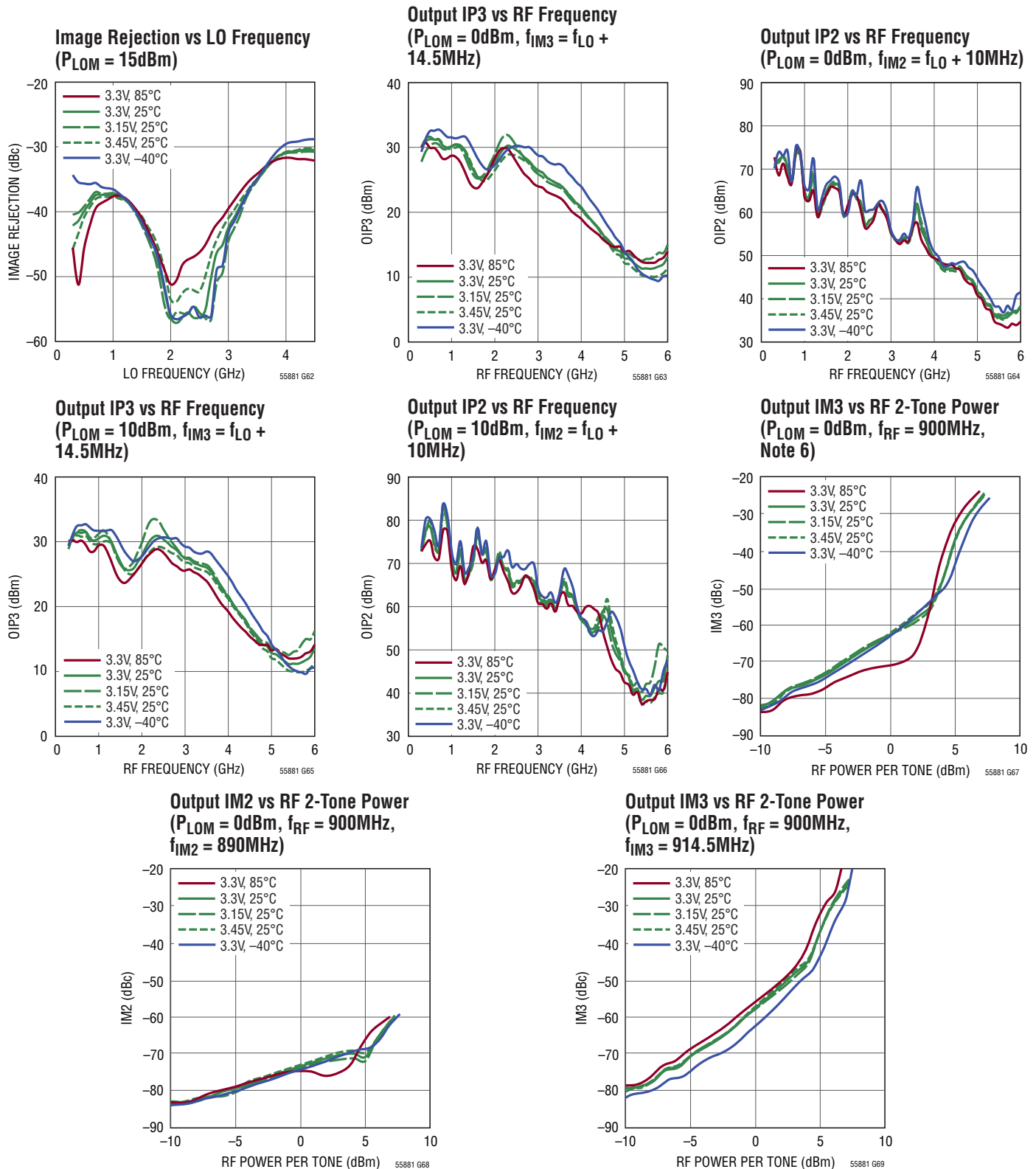

TYPICAL PERFORMANCE CHARACTERISTICS $V_{CC} = 3.3V$, $EN = 3.3V$, $T_A = 25^\circ C$, LOP input AC-terminated with 50Ω to ground, BBPI, BBMI, BBPQ, BBMQ inputs $0.5V_{DC}$, and $1V_{P-P(DIFF)}$, baseband input frequencies = 4.5MHz and 5.5MHz for OIP3 and OIP2, or else baseband input frequency = 100kHz, I and Q 90° shifted, lower sideband selection, LINOPT pin floating, unless otherwise noted. Test circuit is shown in Figure 8.

Output IM2 vs RF 2-Tone Power
($P_{LOM} = 0dBm$, $f_{RF} = 900MHz$,
 $f_{IM2} = 910MHz$)

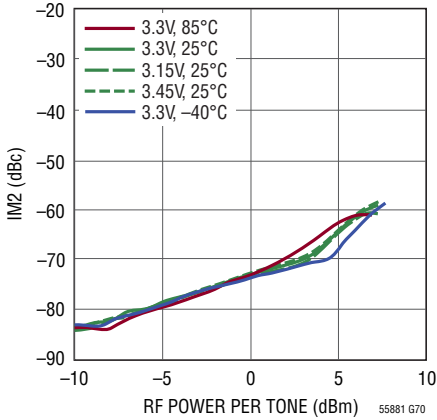

Output IM3 vs RF 2-Tone Power
($P_{LOM} = 0dBm$, $f_{RF} = 2140MHz$,
Note 6)

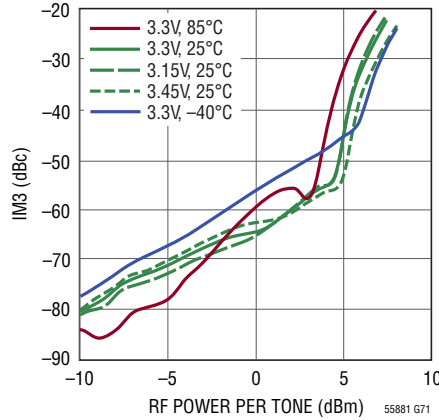

Output IM2 vs RF 2-Tone Power
($P_{LOM} = 0dBm$, $f_{RF} = 2140MHz$,
 $f_{IM2} = 2130MHz$)

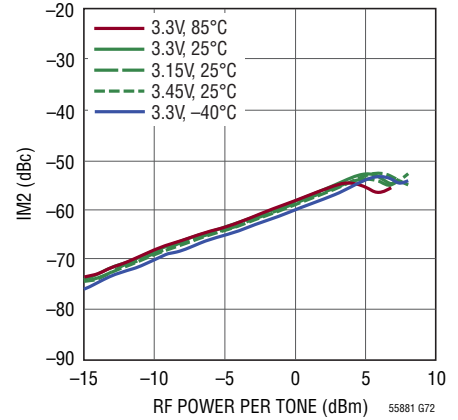

Output IM3 vs RF 2-Tone Power
($P_{LOM} = 0dBm$, $f_{RF} = 2140MHz$,
 $f_{IM3} = 2154.5MHz$)

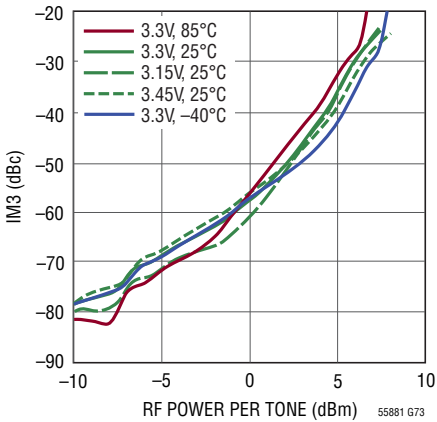

Output IM2 vs RF 2-Tone Power
($P_{LOM} = 0dBm$, $f_{RF} = 2140MHz$,
 $f_{IM2} = 2150MHz$)

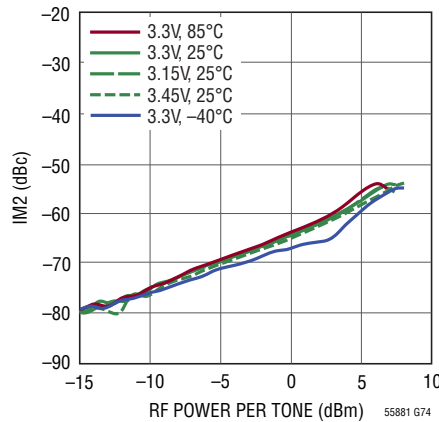

Supply Current vs LINOPT Voltage

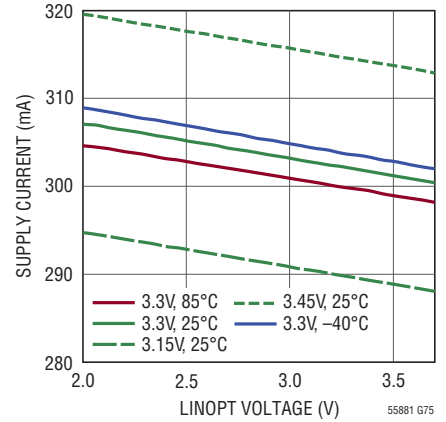

LINOPT Current vs LINOPT Voltage

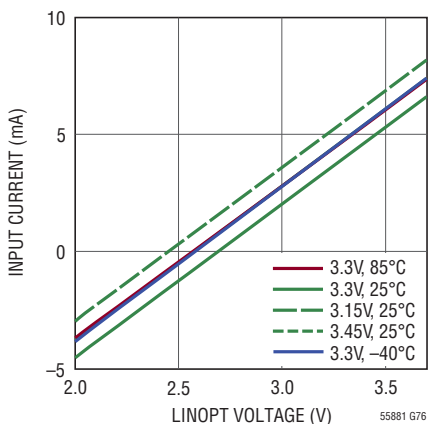

Output IP2 vs RF Frequency for High Side LO Injection
($f_{BB1} = 140MHz$,
 $f_{BB2} = 141MHz$, $P_{LOM} = 0dBm$)

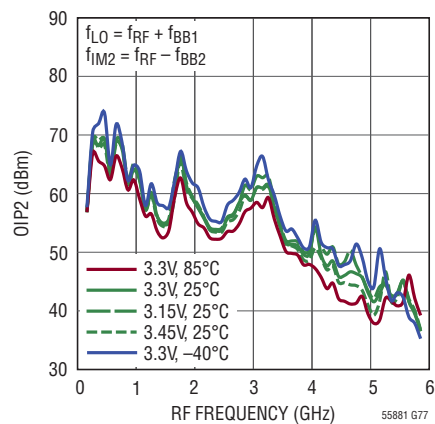

TYPICAL PERFORMANCE CHARACTERISTICS $V_{CC} = 3.3V$, $EN = 3.3V$, $T_A = 25^\circ C$, LOP input AC-terminated with 50Ω to ground, BBPI, BBMI, BBPQ, BBMQ inputs $0.5V_{DC}$, and $1V_{P-P(DIFF)}$, baseband input frequencies = 4.5MHz and 5.5MHz for OIP3 and OIP2, or else baseband input frequency = 100kHz, I and Q 90° shifted, lower sideband selection, LINOPT pin floating, unless otherwise noted. Test circuit is shown in Figure 8.

Output IP2 vs RF Frequency for High Side LO Injection ($f_{BB1} = 140MHz$, $f_{BB2} = 141MHz$, $P_{LOM} = 10dBm$)

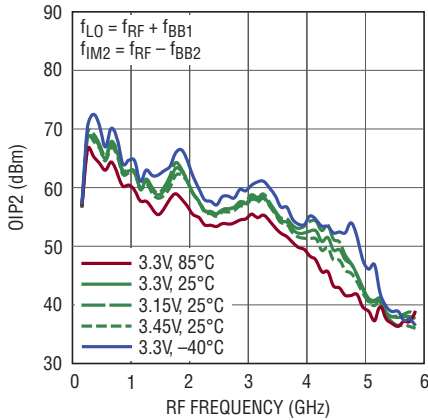

55881 G78

Output IP2 vs RF Frequency for Low Side LO Injection ($f_{BB1} = 140MHz$, $f_{BB2} = 141MHz$, $P_{LOM} = 0dBm$)

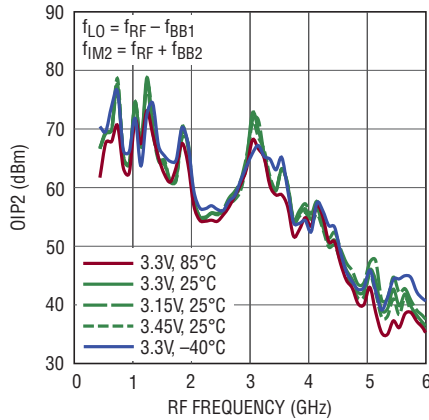

55881 G79

Output IP2 vs RF Frequency for Low Side LO Injection ($f_{BB1} = 140MHz$, $f_{BB2} = 141MHz$, $P_{LOM} = 10dBm$)

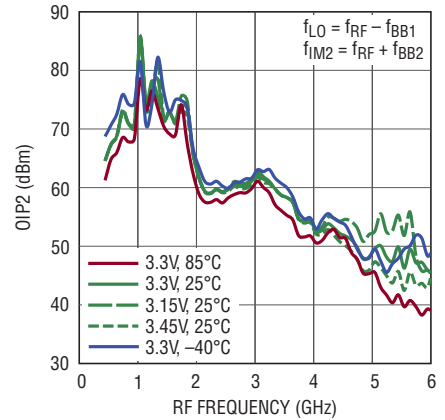

55881 G80

GNDRF to GND Thermistor DC Resistance vs Temperature ($I_{GNDRF(DC)} = 100\mu A$)

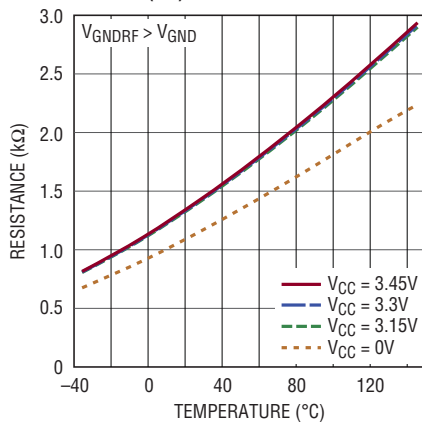

55881 G81

GNDRF to GND Thermistor DC Resistance vs Temperature ($I_{GNDRF(DC)} = 200\mu A$)

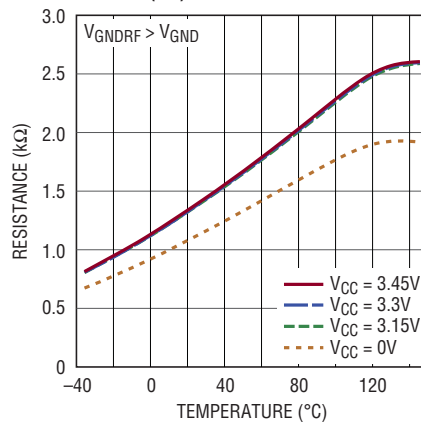

55881 G82

PIN FUNCTIONS

EN (Pin 1): Enable Input. When the enable pin voltage is higher than 2V, the IC is on. When the input voltage is less than 1V, the IC is off.

GND (Pins 2, 5, 8, 11, 12, 14, 17, 19, 20, 23, Exposed Pad Pins 25 and 26): Ground. Pins 2, 5, 8, 11, 20, 23 and exposed pad Pin 25 (group 1) are connected together internally while Pins 12, 14, 17, 19 and exposed pad Pin 26 (group 2) are tied together and serve as the ground return for the RF balun. For best overall performance all ground pins should be connected to RF ground. For best OIP2 performance it is recommended to connect group 1 and group 2 only at second and lower level ground layers of the PCB, not the top layer. A thermistor (temperature variable resistor) of 1.4k Ω at 25°C and $V_{CC} = 3.3V$ with temperature coefficient of 11 Ω /°C is connected between group 1 and group 2.

LOP (Pin 3): Positive LO Input. An AC-coupling capacitor (1nF) in series with 50 Ω to ground provides the best OIP2 performance.

LOM (Pin 4): Negative LO Input. An AC-coupled 50 Ω LO signal source can be applied to this pin.

NC (Pins 6, 13, 15): No Electrical Connection.

LINOPT (Pin 7): Linearity Optimization Input. An external voltage can be applied to this pin to optimize the linearity (OIP3) under a specific application condition. Its optimum voltage depends on the LO frequency, temperature, supply voltage, baseband frequency and signal bandwidth. The typical input voltage range is from 2V to 3.7V. The pin can be left floating for good overall linearity performance.

BBMQ, BBPQ (Pins 9, 10): Baseband Inputs of the Q Channel. The input impedance of each input is about -3k Ω . It should be externally biased to a 0.5V common mode level. Do not apply common mode voltage beyond 0.55V_{DC}.

RF (Pin 16): RF Output. The RF output is a DC-coupled single-ended output with 50 Ω output impedance at RF frequencies. An AC-coupling capacitor of 6.2pF (C7), should be used at this pin for 0.7GHz to 3.5GHz operation.

V_{CC1}, V_{CC2} (Pins 24, 18): Power Supply. It is recommended to use 2 \times 1nF and 2 \times 4.7 μ F capacitors for decoupling to ground on these pins.

BBPI, BBMI (Pins 21, 22): Baseband Inputs of the I Channel. The input impedance of each input is about -3k Ω . It should be externally biased to a 0.5V common mode level. Do not apply common mode voltage beyond 0.55V_{DC}.

BLOCK DIAGRAM

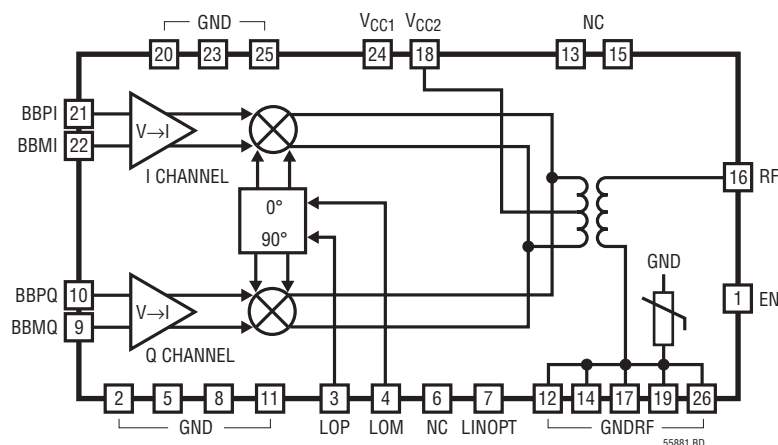

APPLICATIONS INFORMATION

The LTC5588-1 consists of I and Q input differential voltage-to-current converters, I and Q upconverting mixers, an RF output balun, an LO quadrature phase generator and LO buffers.

External I and Q baseband signals are applied to the differential baseband input pins, BBPI, BBMI and BBPQ, BBMQ. These voltage signals are converted to currents and translated to RF frequency by means of double-balanced upconverting mixers. The mixer outputs are combined at the inputs of the RF output balun, which also transforms the output impedance to 50Ω . The center frequency of the resulting RF signal is equal to the LO signal frequency. The LO input drives a phase shifter which splits the LO signal into in-phase and quadrature signals. These LO signals are then applied to on-chip buffers which drive the upconverting mixers. In most applications, the LOM input is driven by the LO source via a 1nF coupling capacitor, while the LOP input is terminated with 50Ω to RF ground via a 1nF coupling capacitor. The RF output is single ended and internally 50Ω matched across a wide RF frequency range from 700MHz to 5GHz with better than 10dB return loss using $C7 = 6.8\text{pF}$ and $C8 = 0.2\text{pF}$ ($S_{22} < -10\text{dB}$). See Figure 8.

For 240MHz operation, $C7 = 4.7\text{nH}$ and $C8 = 33\text{pF}$ is recommended. For 450MHz, $C7 = 2.7\text{nH}$ and $C8 = 10\text{pF}$ is

recommended. Note that the frequency of the best match is set lower than the band center frequency to compensate the gain roll-off of the on-chip RF output balun at lower frequency. At 240MHz and 450MHz operations, the image rejection and the large-signal noise performance is better using higher LO drive levels. However, if the drive level causes internal clipping, the LO leakage degrades. Using a balun such as Anaren P/N B0310J50100A00 increases the LO drive level without internal clipping and provides a relatively broadband LO port impedance match.

Baseband Interface

The baseband inputs (BBPI, BBMI, BBPQ, BBMQ) present a single-ended input impedance of about $-3\text{k}\Omega$. Because of the negative input impedance, it is important to keep the source resistance at each baseband input low enough such that the total input impedance remains positive across the baseband frequency. Each of the four baseband inputs has a capacitor of 4pF in series with 14Ω connected to ground and a PNP emitter follower in parallel (see Figure 1). The baseband bandwidth depends on the source impedance. For a 25Ω source impedance (50Ω terminated with 50Ω), the baseband bandwidth (-1dB) is about 430MHz. If a 2.7nH series inductor is inserted at each of the four baseband inputs, the -1dB baseband bandwidth can be increased to about 650MHz.

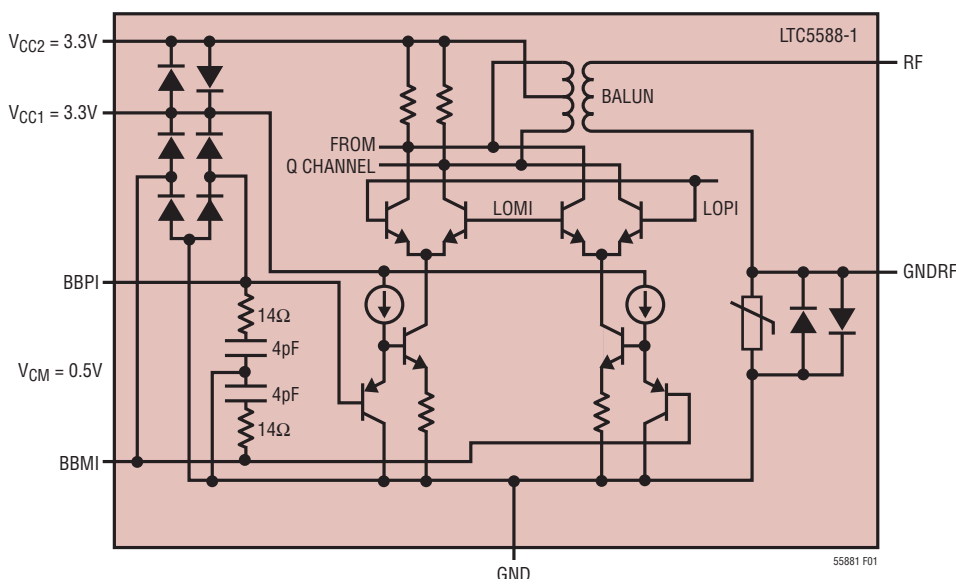

Figure 1. Simplified Circuit Schematic of the LTC5588-1 (Only I Channel is Shown)

APPLICATIONS INFORMATION

It is recommended to compensate the baseband input impedance in the baseband lowpass filter design in order to achieve best gain flatness vs baseband frequency. The S-parameters for (each of) the baseband inputs is given in Table 1.

Table 1. Single-Ended BB Input Impedance vs Frequency for EN = High and $V_{DC} = 0.5V$

FREQUENCY (MHz)	BB INPUT IMPEDANCE	REFLECTION COEFFICIENT	
		MAG	ANGLE
0.1	-3700	1.03	-0.13
1	-3900-j340	1.03	-0.13
2	-3700-j950	1.03	-0.37
4	-3200-j1500	1.03	-0.68
8	-2100-j1900	1.03	-1.38
16	-860-j1600	1.03	-2.79
30	-300-j990	1.03	-5.3
60	-87-j520	1.03	-10.6
100	-35-j308	1.04	-18.2
140	-16-j226	1.03	-24.8
200	-6-j154	1.02	-36
250	-1.4-j120	1.01	-45
300	1.4-j102	0.99	-52
350	4.4-j87	0.96	-59
400	5.4-j74	0.94	-67
450	7-j66	0.90	-73
500	8.3-j58	0.87	-80
600	9.4-j47	0.82	-92
700	10-j38	0.77	-102
800	10-j32	0.74	-113
900	10.5-j27	0.71	-122
1000	10.5-j23	0.69	-129

The circuit is optimized for a common mode voltage of 0.5V which should be externally applied. The baseband pins should not be left floating to cause the internal PNP's base current to pull the common mode voltage higher than the 0.55V limit, generating excessive current flow. If it occurs for an extended period, damage to the IC may result. In shutdown mode it is recommended to terminate to ground or to a 0.5V source with a value lower than 200Ω. The PNP's base current is about $-136\mu A$ ranging from $-250\mu A$ to $-50\mu A$.

It is recommended to drive the baseband inputs differentially to reduce even-order distortion products. When a DAC is used as the signal source, a reconstruction filter should be placed between the DAC output and the LTC5588-1 baseband inputs to avoid aliasing.

Figure 2 shows a typical baseband interface for zero-IF repeater application. A 5th-order lowpass ladder filter is used with $-0.3dB$ cut-off of 60MHz. C1A, C1B, C3A and C3B are configured in a single-ended fashion in order to suppress common mode noise. L3A and L3B (0402 size) are used to compensate for passband droop due to the finite quality factor of the inductors L1A, L1B, L2A and L2B (0603 size). R3A and R3B improves the out-of-band noise performance. R3A = R3B = 0Ω (L3A and L3B omitted) provides best out-of-band noise performance but no passband droop compensation. In that case, L1A, L1B, L2A and L2B may have to be increased in size (higher quality factor) to limit passband droop.

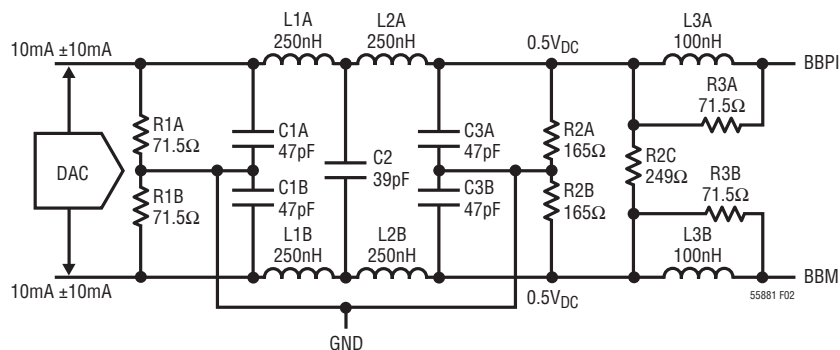

Figure 2: Baseband Interface with 5th-Order Filter and 0.5V_{CM} DAC (Only I Channel is Shown)

APPLICATIONS INFORMATION

At each baseband pin, a 0.146V to 0.854V swing is developed corresponding to a DAC output current of 0mA to 20mA. A 3dB lower gain can be achieved using $R1A = R1B = 49.9\Omega$; $R2A = R2B = \text{Open}$; $R2C = 100\Omega$; $R3A = R3B = 51\Omega$; $L1A = L1B = L2A = L2B = 180\text{nH}$; $C1A = C1B = C3A = C3B = 68\text{pF}$; $C2 = 56\text{pF}$.

LO Section

The internal LO chain consists of a quadrature phase shifter followed by LO buffers. The LOM input can be driven single ended with 50Ω input impedance, while the LOP input should be terminated with 50Ω through a DC blocking capacitor.

The LOP and LOM inputs can also be driven differentially when an exceptionally low large-signal output noise floor is required.

A simplified circuit schematic for the LOP and LOM inputs is given in Figure 3. Table 2 lists LOM port input impedance vs frequency at EN = High and $P_{\text{LOM}} = 0\text{dBm}$. For EN = Low and $P_{\text{LOM}} = 0\text{dBm}$ the input impedance is given in Table 3. The LOM port input impedance is shown for EN = High and Low at $P_{\text{LOM}} = 10\text{dBm}$ in Table 4 and Table 5, respectively. The circuit schematic of the demo board is shown in Figure 8. A 50Ω termination can be connected to the LOP port (J1).

The LOM port (J2) can also be terminated with a 50Ω while the LO power is applied to the LOP (J1) port. In that case, the image rejection may be degraded. At 2.14GHz, the large-signal noise figure is about 2dB better for dif-

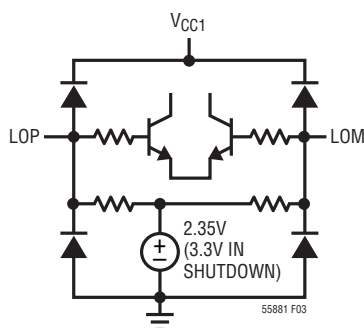

Figure 3: Simplified Circuit Schematic for the LOP and LOM inputs

ferential LO drive (using BD1631J50100A00) with a LO power below 10dBm. The balun (U2) can be installed by removing C5 and C6 (see Figure 8). Using Anaren P/N B0310J50100A00 improves image, LO leakage and large-signal noise performance at 240MHz and 450MHz. For this particular balun, an external blocking capacitor is required.

Figure 4 shows the return loss vs RF frequency for the 240MHz and 450MHz frequency bands. Figure 5 shows the corresponding gain vs RF frequency where the gain curve peaks at a higher frequency compared to the frequency with best match. Note that the overall bandwidth degrades tuning the matching frequency lower. A similar technique can be used for 700MHz and 900MHz if gain flatness is important.

Table 2. LOM Port Input Impedance vs Frequency for EN = High and $P_{\text{LOM}} = 0\text{dBm}$ (LOP Terminated with 50Ω AC to Ground)

FREQUENCY (GHz)	LOM INPUT IMPEDANCE	REFLECTION COEFFICIENT	
		MAG	ANGLE
0.2	98-j65	0.499	-29.8
0.25	87-j58	0.462	-34.3
0.3	79-j51	0.421	-38.8
0.4	69-j40	0.354	-45.8
0.5	63-j32	0.296	-52.4
0.6	59-j27	0.256	-58.4
0.7	55-j24	0.225	-64.9
0.8	52-j21	0.203	-72.5
0.9	50-j19	0.188	-79.6
1.0	48-j18	0.18	-86.9
1.2	44-j16	0.178	-101
1.4	41-j15	0.185	-111
1.6	39-j14	0.194	-118
1.8	38-j13	0.2	-123
2.0	37-j12	0.199	-128
2.5	36-j7.8	0.189	-146
3.0	32-j2.4	0.225	-171
3.5	28+j1.0	0.288	176
4.0	25+j2.4	0.35	173
4.5	23+j4.1	0.372	168
5.0	21+j6.2	0.417	162
5.5	19+j7.9	0.472	159
6.0	17+j8.7	0.519	157

APPLICATIONS INFORMATION

Table 3. LOM Port Input Impedance vs Frequency for EN = Low and P_{LOM} = 0dBm (LOP Terminated with 50Ω AC to Ground)

FREQUENCY (GHz)	LOM INPUT IMPEDANCE	REFLECTION COEFFICIENT	
		MAG	ANGLE
0.2	95-j69	0.511	-31.4
0.25	84-j61	0.472	-36.2
0.3	76-j53	0.43	-41
0.4	67-j41	0.36	-48.5
0.5	61-j33	0.3	-55.6
0.6	57-j28	0.259	-61.9
0.7	54-j24	0.228	-68.7
0.8	51-j21	0.205	-76.5
0.9	48-j19	0.191	-83.6
1.0	47-j18	0.183	-90.9
1.2	43-j16	0.182	-105
1.4	40-j15	0.19	-114
1.6	39-j14	0.2	-121
1.8	38-j13	0.207	-125
2.0	37-j12	0.205	-131
2.5	35-j7.6	0.2	-149
3.0	31-j2.2	0.238	-172
3.5	27+j1.3	0.303	175
4.0	24+j2.9	0.363	171
4.5	22+j4.7	0.387	166
5.0	21+j7.0	0.427	160
5.5	18+j8.7	0.481	157
6.0	16+j9.7	0.524	154

Table 4. LOM Port Input Impedance vs Frequency for EN = High and P_{LOM} = 10dBm (LOP Terminated with 50Ω AC to Ground)

FREQUENCY (GHz)	LOM INPUT IMPEDANCE	REFLECTION COEFFICIENT	
		MAG	ANGLE
0.2	96-j64	0.494	-30.6
0.25	86-j57	0.455	-35.1
0.3	77-j51	0.42	-40.2
0.4	69-j41	0.356	-46.6
0.5	62-j33	0.3	-54.1
0.6	58-j28	0.258	-59.1
0.7	55-j24	0.229	-66.6
0.8	52-j21	0.203	-73.1
0.9	50-j19	0.192	-80.6
1.0	48-j18	0.179	-87.5
1.2	44-j16	0.176	-102
1.4	41-j15	0.185	-112
1.6	39-j14	0.196	-119
1.8	38-j14	0.202	-123
2.0	37-j12	0.201	-128
2.5	36-j7.9	0.188	-146
3.0	32-j2.7	0.225	-170
3.5	28+j0.8	0.292	176
4.0	24+j2.0	0.348	172
4.5	23+j3.6	0.373	168
5.0	21+j5.9	0.42	162
5.5	19+j7.5	0.468	159
6.0	16+j8.5	0.518	157

APPLICATIONS INFORMATION

Table 5. LOM Port Input Impedance vs Frequency for EN = Low and $P_{LOM} = 10\text{dBm}$ (LOP Terminated with 50Ω AC to Ground)

FREQUENCY (GHz)	LOM INPUT IMPEDANCE	REFLECTION COEFFICIENT	
		MAG	ANGLE
0.2	92-j61	0.48	-32.1
0.25	83-j55	0.444	-36.9
0.3	75-j50	0.414	-42
0.4	66-j39	0.345	-49.3
0.5	60-j32	0.293	-57.4
0.6	56-j27	0.251	-63.2
0.7	53-j23	0.225	-71.2
0.8	50-j20	0.199	-78.8
0.9	48-j19	0.191	-86.6
1.0	46-j17	0.18	-93.6
1.2	42-j15	0.181	-108
1.4	40-j14	0.192	-117
1.6	38-j14	0.205	-123
1.8	37-j13	0.211	-127
2.0	36-j12	0.212	-132
2.5	35-j7.5	0.202	-150
3.0	31-j2.2	0.244	-172
3.5	27+j1.3	0.31	175
4.0	24+j2.7	0.363	171
4.5	22+j4.4	0.389	166
5.0	20+j6.8	0.433	160
5.5	18+j8.5	0.479	157
6.0	16+j9.5	0.525	154

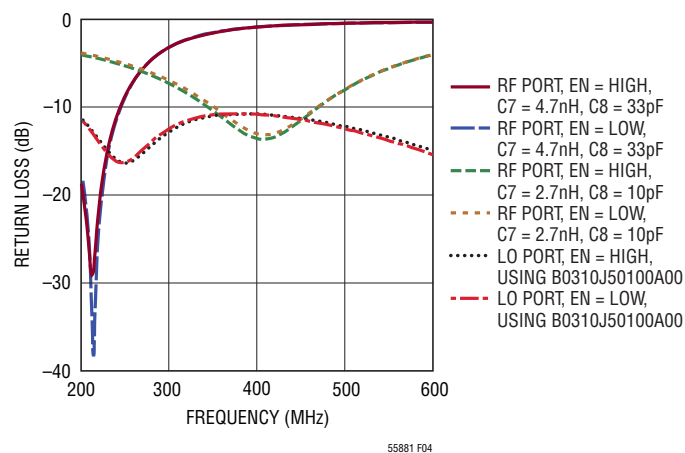

Figure 4. RF and LO Port Return Loss vs Frequency for Low Band Match (See Figure 8)

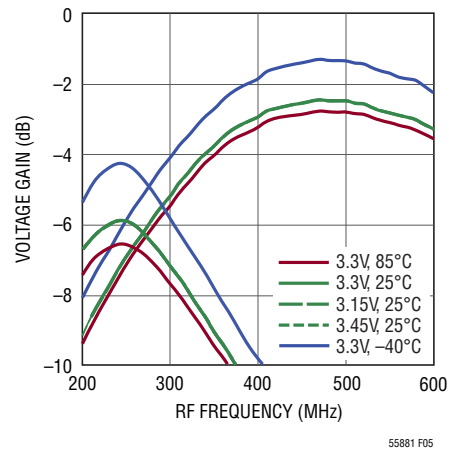

Figure 5. Low Band Voltage Gain vs RF Frequency Using Figure 4 Matching

The third harmonic content of the LO can degrade image rejection severely, it is recommended to keep the 3rd-order harmonic of the LO signal lower than the desirable image rejection minus 6dB. Although the second harmonic content of the LO is less sensitive, it can still be significant. The large-signal noise figure can be improved with higher LO input power. However, if the LO input power is too large to cause the internal LO signal clipping in the phase-shifter section, the image rejection can be degraded rapidly. This clipping point depends on the supply voltage, LO frequency, temperature and single ended vs differential LO drive. At $f_{LO} = 2140\text{MHz}$, $V_{CC} = 3.3\text{V}$, $T = 25^\circ\text{C}$ and single-ended LO drive, this clipping point is at about 16.7dBm. For 3.15V it lowers to 16.1dBm. For differential drive it is about 21.6dBm.

The differential LO port input impedance for EN = High and $P_{LO} = 10\text{dBm}$ is given in Table 6.

APPLICATIONS INFORMATION

Table 6: Differential LO Input Impedance vs Frequency for EN = High and $P_{LO} = 10\text{dBm}$

FREQUENCY (MHz)	LO DIFFERENTIAL INPUT IMPEDANCE	REFLECTION COEFFICIENT	
		MAG	ANGLE
0.2	134-j48	0.247	-43
0.25	126-j51	0.247	-50
0.3	119-j46	0.223	-55
0.4	109-j45	0.215	-66
0.5	100-j40	0.194	-79
0.6	97-j36	0.181	-84
0.7	94-j36	0.184	-90
0.8	90-j35	0.186	-96
0.9	84-j34	0.198	-104
1.0	83-j33	0.198	-107
1.2	77-j36	0.237	-111
1.4	76-j37	0.243	-111
1.6	73-j38	0.262	-113
1.8	74-j37	0.254	-113
2.0	74-j35	0.251	-115
2.5	78-j28	0.199	-120
3.0	74-j15	0.173	-145
3.5	67-j2.9	0.197	-174
4.0	58+j7.3	0.275	168
4.5	51+j15	0.338	158
5.0	42+j18	0.433	156
5.5	34+j20	0.515	156
6.0	27+j16	0.596	160

Table 7: Differential LO Input Impedance vs Frequency for EN = Low and $P_{LO} = 10\text{dBm}$

FREQUENCY (MHz)	LO DIFFERENTIAL INPUT IMPEDANCE	REFLECTION COEFFICIENT	
		MAG	ANGLE
0.2	131-j48	0.243	-45
0.25	125-j52	0.250	-52
0.3	117-j46	0.221	-58
0.4	107-j45	0.215	-69
0.5	98-j40	0.197	-81
0.6	95-j36	0.183	-87
0.7	92-j35	0.186	-93
0.8	88-j34	0.188	-99
0.9	83-j33	0.200	-107
1.0	82-j32	0.199	-110
1.2	75-j35	0.237	-114
1.4	76-j35	0.240	-113
1.6	72-j36	0.259	-115
1.8	74-j35	0.248	-115
2.0	73-j33	0.245	-118
2.5	77-j25	0.191	-125
3.0	73-j12	0.172	-152
3.5	66-j0.2	0.206	180
4.0	56+j10	0.293	164
4.5	49+j18	0.362	154
5.0	39+j21	0.459	153
5.5	32+j22	0.538	153
6.0	25+j18	0.619	158

APPLICATIONS INFORMATION

RF Section

After upconversion, the RF outputs of the I and Q mixers are combined. An on-chip balun performs internal differential to single-ended conversion, while transforming the output signal to 50Ω as shown in Figure 1.

Table 8 shows the RF port output impedance vs frequency for EN = High.

Table 8. RF Output Impedance vs Frequency for EN = High

FREQUENCY (MHz)	RF OUTPUT IMPEDANCE	REFLECTION COEFFICIENT	
		MAG	ANGLE
0.2	7.8+j11	0.742	154
0.25	8.7+j13	0.723	149
0.3	9.7+j16	0.702	143
0.4	12+j21	0.660	133
0.5	16+j25	0.609	123
0.6	19+j29	0.560	114
0.7	24+j32	0.509	106
0.8	30+j34	0.457	98
0.9	35+j35	0.409	91
1.0	41+j34	0.359	85
1.2	52+j28	0.266	70
1.4	58+j18	0.180	57
1.6	58+j7.1	0.098	39
1.8	55+j0.2	0.042	3.4
1.9	52-j2.7	0.032	-52
2.0	50-j4.3	0.043	-92
2.5	39-j5.9	0.142	-149
3.0	32-j1.9	0.227	-173
3.2	30-j0.2	0.255	-180
3.5	27+j2.2	0.298	172
4.0	23+j4.5	0.365	167
4.5	22+j6.8	0.406	161
5.0	19+j11	0.475	151
5.5	17+j20	0.541	133
6.0	15+j27	0.613	120

The RF port output impedance for EN = Low is given in Table 9.

Table 9. RF Output Impedance vs Frequency for EN = Low

FREQUENCY (MHz)	RF OUTPUT IMPEDANCE	REFLECTION COEFFICIENT	
		MAG	ANGLE
0.2	7.2+j11	0.761	155
0.25	8.0+j13	0.742	149
0.3	9.0+j16	0.720	144
0.4	12+j21	0.675	133
0.5	15+j25	0.622	123
0.6	19+j29	0.571	115
0.7	23+j32	0.518	107
0.8	29+j34	0.464	99
0.9	35+j35	0.414	92
1.0	40+j34	0.363	86
1.2	51+j28	0.266	72
1.4	57+j18	0.175	60
1.6	57+j7.0	0.090	43
1.8	53+j0.4	0.030	7.0
1.9	51-j2.4	0.025	-74
2.0	48-j4.0	0.044	-111
2.5	38-j4.9	0.153	-155
3.0	31-j0.7	0.240	-177
3.2	29+1.0	0.266	-177
3.5	27+j3.6	0.308	169
4.0	24+j5.6	0.365	164
4.5	22+j6.9	0.405	161
5.0	19+j11	0.478	151
5.5	17+j20	0.563	132
6.0	15+j28	0.628	118

APPLICATIONS INFORMATION

Linearity Optimization

The LINOPT pin (Pin 7) can be used to optimize the linearity of the RF circuitry. Figure 6 shows the simplified schematic of the LINOPT pin interface. The nominal DC bias voltage of the LINOPT pin is 2.56V and the typical voltage window to drive the LINOPT pin for optimum linearity is 2V to 3.7V. Since its input impedance for EN = High is about 150Ω , an external buffer may be required to output a current in the range of -2mA to 8mA . The LINOPT voltage for optimum linearity is a function of LO frequency, temperature, supply voltage, baseband frequency, high side or low side LO injection, process, signal bandwidth and RF output level.

For zero-IF systems the spectral regrowth is typically limited by the OIP2 performance. In that case, optimizing the LINOPT pin voltage may not improve the spectral regrowth. The spectral regrowth for systems with an IF (for example 140MHz) will be set by the OIP3 performance and optimizing LINOPT voltage can improve the spectral regrowth significantly (see Figure 13).

Enable Interface

Figure 7 shows a simplified schematic of the EN pin interface. The voltage necessary to turn on the LTC5588-1 is 2V. To disable (shut down) the chip, the enable voltage must be below 1V. If the EN pin is not connected, the chip is enabled. This EN = High condition is assured by the 100k on-chip pull-up resistor.

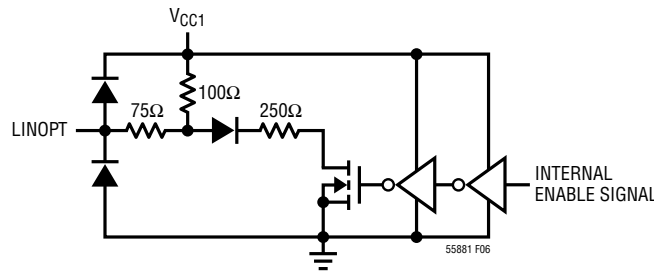

Figure 6. LINOPT Pin Interface

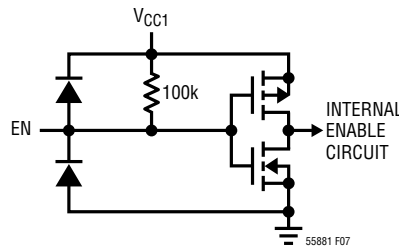

Figure 7. EN Pin Interface

APPLICATIONS INFORMATION

Evaluation Board

Figure 8 shows the evaluation board schematic. A good ground connection is required for the exposed pad. If this is not done properly, the RF performance will degrade. Additionally, the exposed pad provides heat sinking for the part and minimizes the possibility of the chip overheating. Resistors R1 and R2 reduce the charging current in capacitors C1 and C2 (see Figure 8) and will reduce supply ringing during a fast power supply ramp-up with inductive wiring connecting V_{CC} and GND. For EN = High, the

voltage drop over R1 and R2 is about 0.15V. The supply voltages applied directly to the chip can be monitored by measuring at the test points TP1 and TP2. If a power supply is used that ramps up slower than $7V/\mu s$ and limits the overshoot on the supply below 3.8V, R1 and R2 can be omitted. To facilitate turn-on and turn-off time measurements, the microstrip between J5 and J7 can be used connecting J5 to a pulse generator, J7 to an oscilloscope with 50Ω input impedance, removing R5 and inserting a 0Ω resistor for R3.

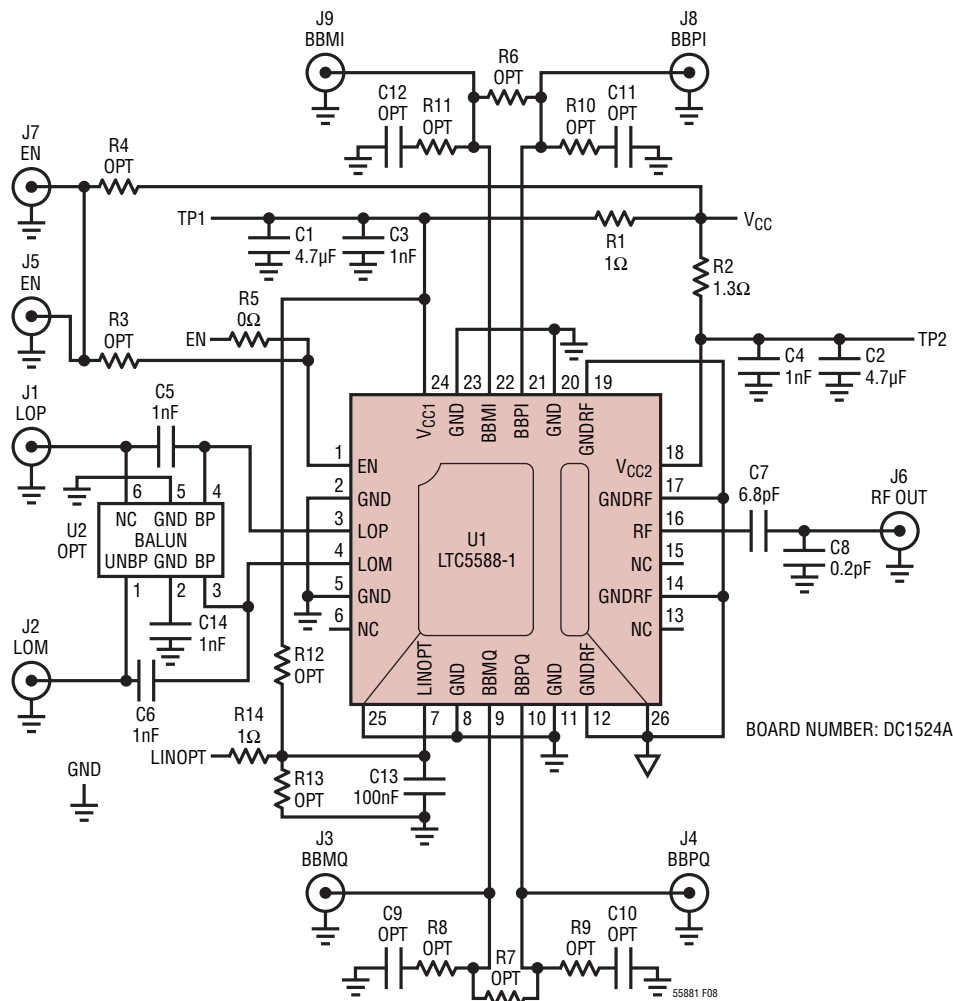

Figure 8. Evaluation Circuit Schematic

APPLICATIONS INFORMATION

Figures 9 and 10 show the component side and the bottom side of the evaluation board. An enlarged view of the component side around the IC placement shows all pins related to GND (group 1) and all pins related to GNDRF (group 2) are not connected via the top layer of the component side in Figure 11. It is possible to use the part without a split-paddle PCB island, but this may degrade OIP2 by a few dB at some frequencies and reduce LO leakage slightly.

Due to self heating, the board temperature on the bottom side underneath the exposed die paddle for EN = high and $V_{CC} = 3.3V$ is $-29.5^{\circ}C$ at $-40^{\circ}C$, $37.8^{\circ}C$ at $25^{\circ}C$ and $98.1^{\circ}C$ at $85^{\circ}C$ ambient temperatures.

The on-chip temperature can be obtained using the built-in thermistor. The on-chip thermistor is internally connected between GNDRF and GND, requiring AC grounding Pins 12, 14, 17, 19 and the exposed pad pin 26. The thermistor is $1.4k\Omega$ at $25^{\circ}C$ and $V_{CC} = 3.3V$, and has a temperature coefficient of $11\Omega/^{\circ}C$. Switching from EN = Low to EN = High causes a $1.5mV$ DC voltage increase on the (AC grounded) GNDRF due to the internal IR drop.

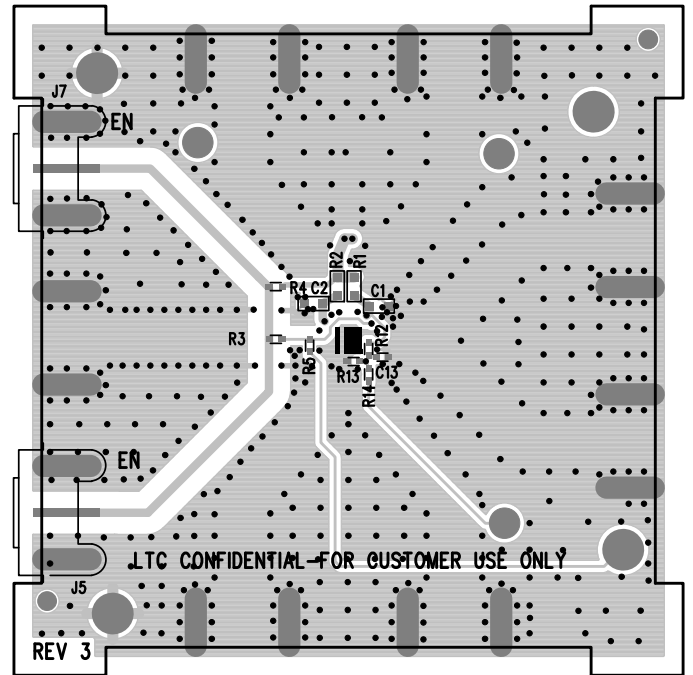

Figure 10. Bottom Side of Evaluation Board

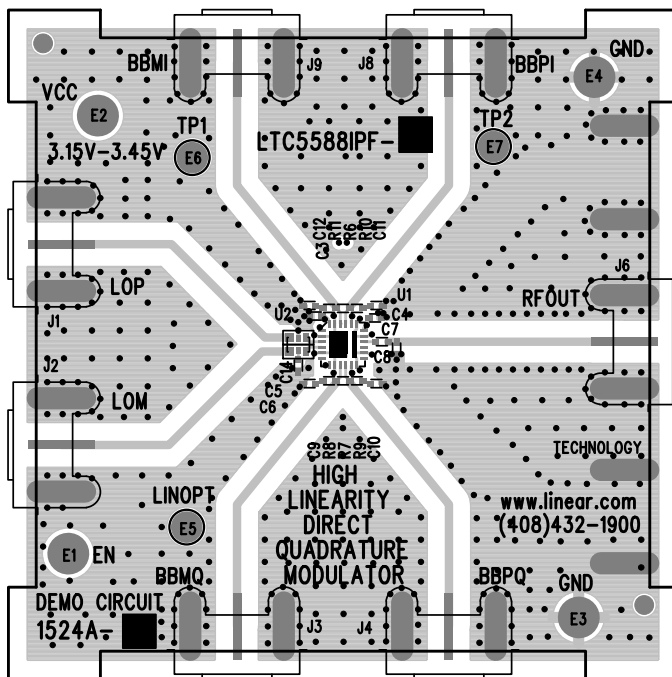

Figure 9. Component Side of Evaluation Board

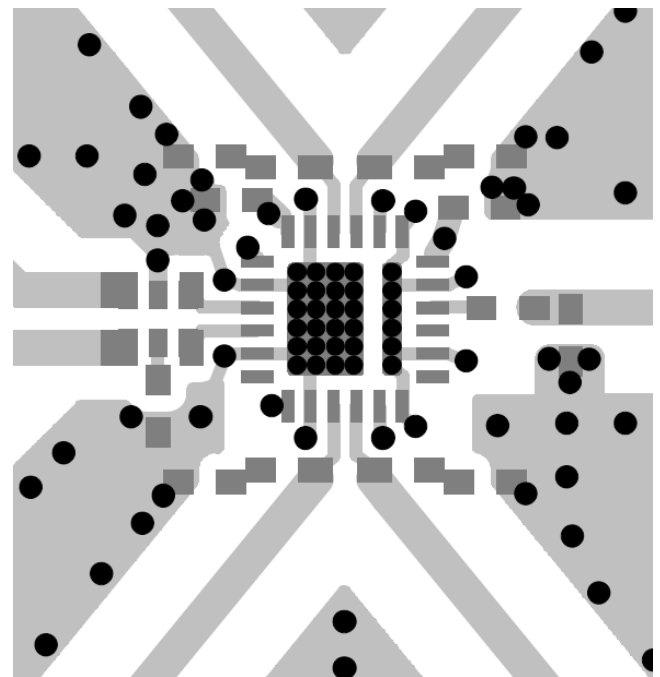

Figure 11. Enlarged View of the Component Side of the Evaluation Board

APPLICATIONS INFORMATION

The LTC5588-1 is recommended for basestation applications using various modulation formats. Figure 14 shows a typical application. The LTC2630 can be used to drive the LINOPT pin via a SPI interface. At 3.3V supply, the maximum LINOPT voltage is about 3.125V. Using an extra buffer like the LTC6246 in unity-gain configuration can increase the maximum LINOPT voltage to about 3.17V. An LTC2630 with a 5V supply can drive the full 2V to 3.7V range for the LINOPT pin.

Figure 12 shows the ACPR, AltCPR and ACPR, AltCPR with Optimized LINOPT voltage vs RF Output Power at 2.14GHz for W-CDMA 1, 2 and 4 Carriers. A 4-Carriers W-CDMA spectrum is shown in Figure 13 with and without LINOPT voltage optimization.

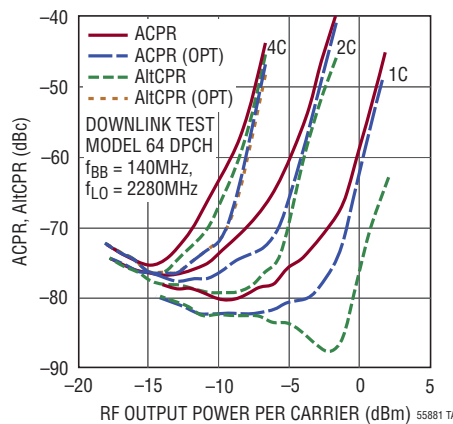

Figure 12. ACPR, AltCPR and ACPR, AltCPR with Optimized LINOPT Voltage vs RF Output Power at 2.14GHz for W-CDMA 1, 2 and 4 Carriers

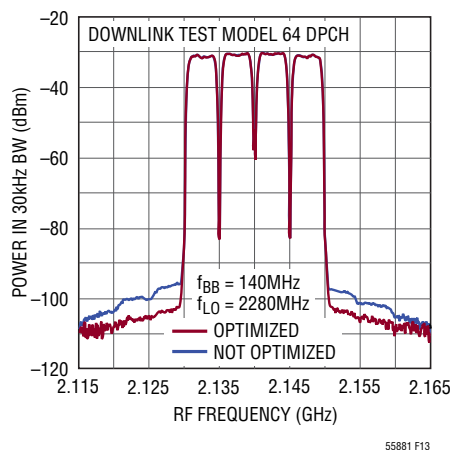
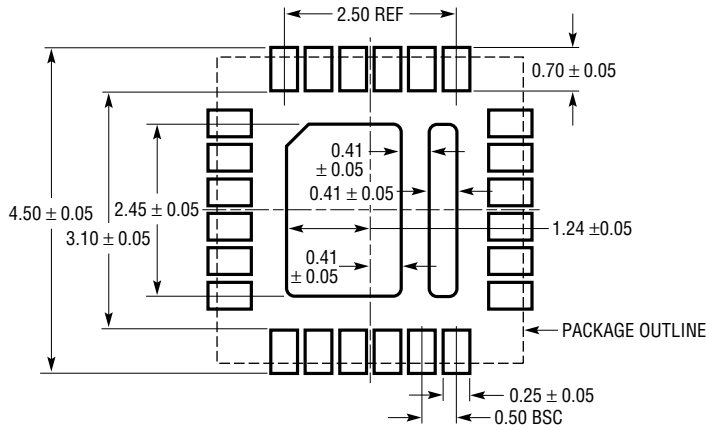

Figure 13. 4-Carrier W-CDMA Spectrum with and without LINOPT Voltage Optimization

PACKAGE DESCRIPTION

PF Package
Variation: PF24MA
24-Lead Plastic UTQFN (4mm × 4mm)
 (Reference LTC DWG # 05-08-1834 Rev 0)



RECOMMENDED SOLDER PAD PITCH AND DIMENSIONS
 APPLY SOLDER MASK TO AREAS THAT ARE NOT SOLDERED

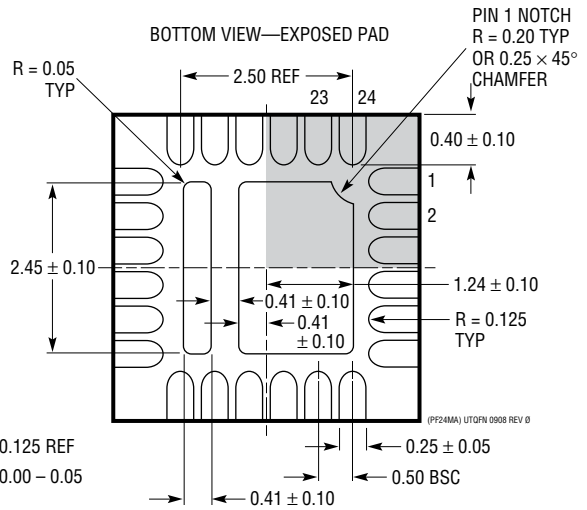
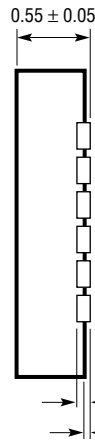
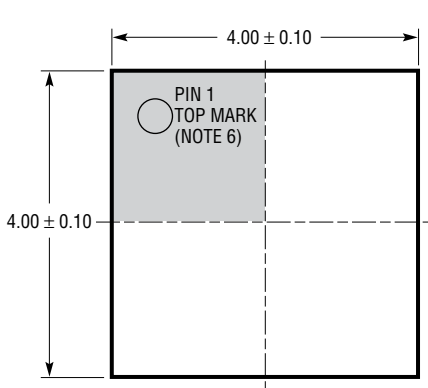

- NOTE:
1. DRAWING IS NOT A JEDEC PACKAGE OUTLINE
 2. DRAWING NOT TO SCALE
 3. ALL DIMENSIONS ARE IN MILLIMETERS
 4. DIMENSIONS OF EXPOSED PAD ON BOTTOM OF PACKAGE DO NOT INCLUDE MOLD FLASH. MOLD FLASH, IF PRESENT, SHALL NOT EXCEED 0.15mm ON ANY SIDE, IF PRESENT
 5. EXPOSED PAD SHALL BE SOLDER PLATED
 6. SHADED AREA IS ONLY A REFERENCE FOR PIN 1 LOCATION ON THE TOP AND BOTTOM OF PACKAGE

REVISION HISTORY

REV	DATE	DESCRIPTION	PAGE NUMBER
A	2/11	Updated Features and Description sections	1
		Add θ_{JC} value to Pin Configuration	2
		Additional information added to Electrical Characteristics section	5
		Added Typical Performance Characteristics curves	14, 15
		Revised Applications Information to replace Figure 1 and text.	17, 26
B	3/11	Added Note 14 to Electrical Characteristics section.	5

TYPICAL APPLICATION

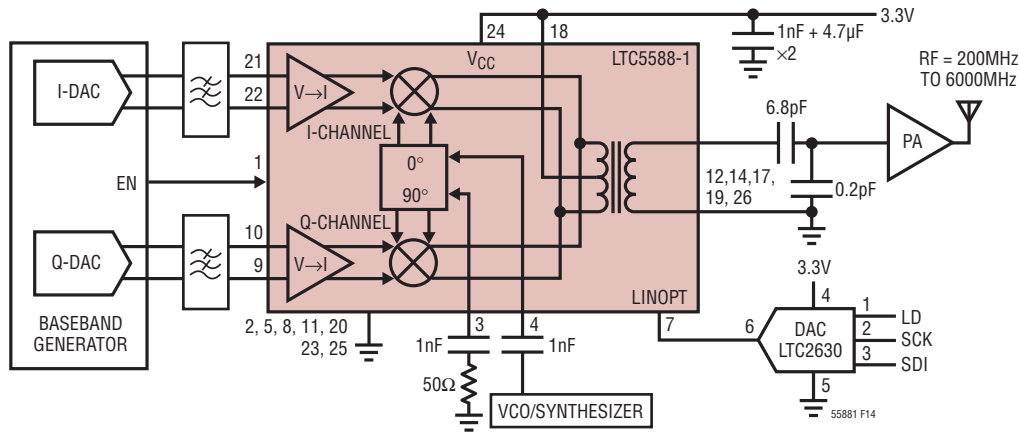

Figure 14. 200MHz to 6000MHz Direct Conversion Transmitter Application

RELATED PARTS

PART NUMBER	DESCRIPTION	COMMENTS
Infrastructure		
LT [®] 5518	1.5GHz to 2.4GHz High Linearity Direct Quadrature Modulator	22.8dBm OIP3 at 2GHz, -158.2dBm/Hz Noise Floor, 3k Ω 2.1V _{DC} Baseband Interface, 5V/128mA Supply
LT5528	1.5GHz to 2.4GHz High Linearity Direct Quadrature Modulator	21.8dBm OIP3 at 2GHz, -159.3dBm/Hz Noise Floor, 50 Ω 0.5V _{DC} Baseband Interface, 5V/128mA Supply
LT5558	600MHz to 1100MHz High Linearity Direct Quadrature Modulator	22.4dBm OIP3 at 900MHz, -158dBm/Hz Noise Floor, 3k Ω 2.1V _{DC} Baseband Interface, 5V/108mA Supply
LT5568	700MHz to 1050MHz High Linearity Direct Quadrature Modulator	22.9dBm OIP3 at 850MHz, -160.3dBm/Hz Noise Floor, 50 Ω 0.5V _{DC} Baseband Interface, 5V/117mA Supply
LT5571	620MHz to 1100MHz High Linearity Direct Quadrature Modulator	21.7dBm OIP3 at 900MHz, -159dBm/Hz Noise Floor, Hi-Z 0.5V _{DC} Baseband Interface, 5V/97mA Supply
LT5572	1.5GHz to 2.5GHz High Linearity Direct Quadrature Modulator	21.6dBm OIP3 at 2GHz, -158.6dBm/Hz Noise Floor, Hi-Z 0.5V _{DC} Baseband Interface, 5V/120mA Supply
LTC5598	5MHz to 1600MHz High Linearity Direct Quadrature Modulator	27.7dBm OIP3 at 140MHz, -160dBm/Hz Noise Floor with P _{OUT} = 5dBm
LTC5540/LTC5541/ LTC5542/LTC5543	600MHz to 4GHz High Linearity Downconverting Mixers	IIP3 = 26.4dBm, 8dB Conversion Gain, <10dB NF, 3.3V/190mA Supply Current
LT5527	400MHz to 3.7GHz, 5V Downconverting Mixer	2.3dB Gain, 23.5dBm IIP3, 12.5dB NF at 1900MHz, 5V/78mA Supply Current
LT5557	400MHz to 3.7GHz, 3.3V Downconverting Mixer	2.9dB Gain, 24.7dBm IIP3, 11.7dB NF at 1950MHz, 3.3V/82mA Supply Current
RF Power Detector		
LT5581	6GHz Low Power RMS Detector	40dB Dynamic Range, \pm 1dB Accuracy Over Temperature, 1.5mA Supply Current
LTC5582	40MHz to 10GHz RMS Power Detector	57dB Dynamic Range, \pm 1dB Accuracy Over Temperature, Single-Ended RF Input (No Transformer)