



PRODUCT SPECIFICATION

Model No : CSM-57071G/CSM-57081G

Descriptions:
<ul style="list-style-type: none"> • 0.7Inch Dot-Matrix Display • 5*7 Array with X-Y Select. • CSM-57071: Column Anode, Row Cathode • CSM-57081: Column Cathode, Row Anode • Emitting Color: Yellow-Green



CUSTOMER APPROVED SIGNATURES	APPROVED BY	CHECKED BY	PREPARED BY

CHINA SEMICONDUCTOR CORPORATION
 Address:2FL. NO.909,Chung-Cheng Road,
 Chung-Ho City Taipei Hsien,Taiwan.

Tel:886-2-2223-9696
 Fax:886-2-2223-9377

OPTO PLUS TECHNOLOGIES CO.,LTD
 Address:696 Shun jiang Rd.,Ji Shan St.Shaoxing,
 ZheJiang,China

Tel:86-0575-88623888
 Fax:86-0575-88623112



Model No : CSM-57071G/CSM-57081G

Features -

1. 0.7 inch (17.2mm) Matrix height.
2. Case mold type.
3. RoHs compliant.
4. Low power consumption.
5. Easy mounting on P.C. board or socket.

Device Selection Guide -

Part No.	Chip		Description	
	Material	Emitted Color	Column	Row
CSM-57071G	GaP	Yellow-Green	Anode	Cathode
CSM-57081G			Cathode	Anode

Package Dimensions -

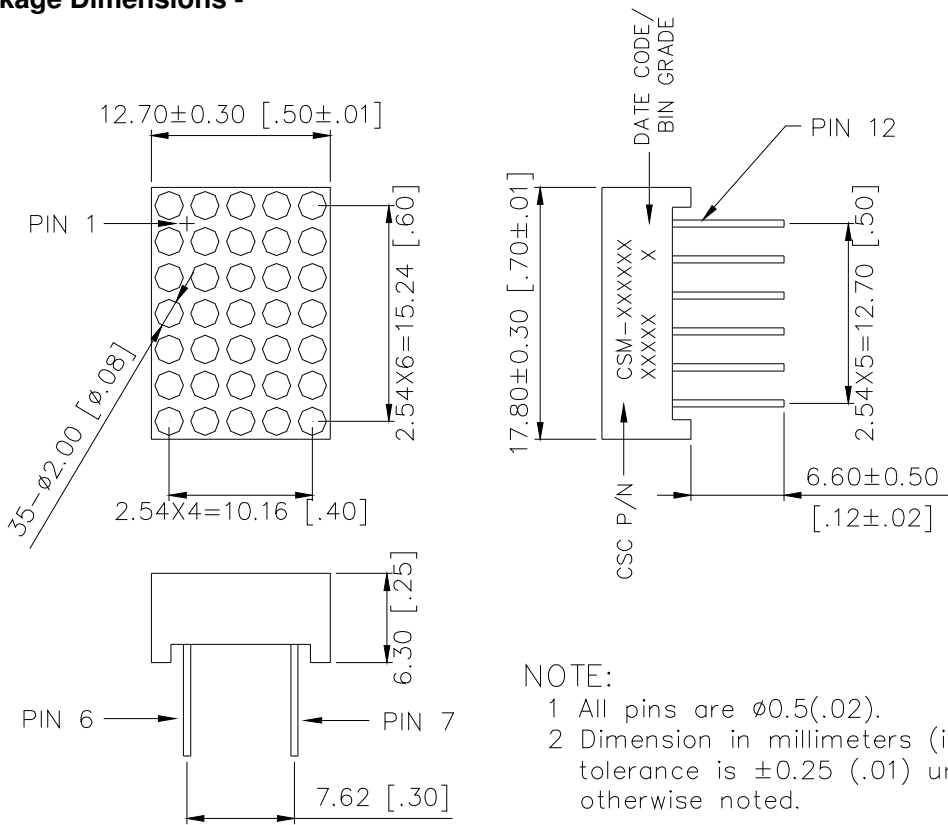

NOTE:

- 1 All pins are $\phi 0.5$ (.02).
- 2 Dimension in millimeters (inch), tolerance is ± 0.25 (.01) unless otherwise noted.



Model No : CSM-57071G/CSM-57081G

Internal Circuit Diagrams -

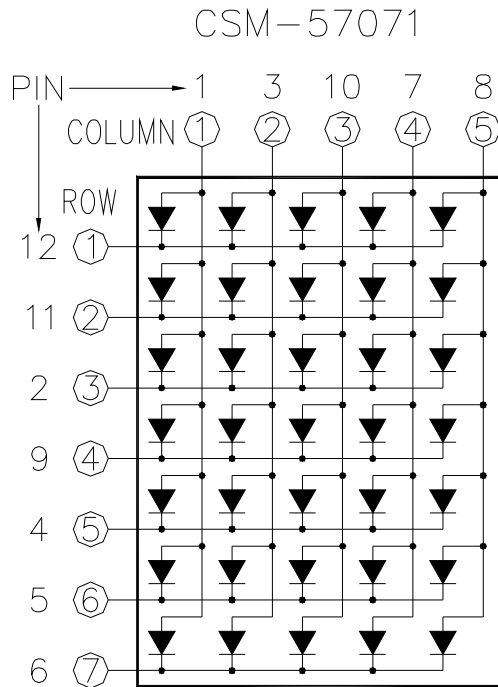

CSM-57071				CSM-57081			
PIN NO.	FUNCTION	PIN NO.	FUNCTION	PIN NO.	FUNCTION	PIN NO.	FUNCTION
1	Anode Column 1	7	Anode Column 4	1	Cathode Column 1	7	Cathode Column 4
2	Cathode Row 3	8	Anode Column 5	2	Anode Row 3	8	Cathode Column 5
3	Anode Column 2	9	Cahtode Row 4	3	Cathode Column 2	9	Anode Row 4
4	Cathode Row 5	10	Anode Column 3	4	Anode Row 5	10	Cathode Column 3
5	Cathode Row 6	11	Cathode Row 2	5	Anode Row 6	11	Anode Row 2
6	Cathode Row 7	12	Cathode Row 1	6	Anode Row 7	12	Anode Row 1



Model No : CSM-57071G/CSM-57081G

■ Absolute Maximum Rating -

(Ta=25°C)

Parameter	Symbol	Rating	Unit
Power Dissipation Per Dice	Pd	70	mW
Continuous Forward Current Per Dice	IAF	25	mA
Peak Current Per Dice(duty cycle 1/10, 1kHz)	IPF	90	mA
Derating Linear From 25°C Per Dice	-	0.33	mA/°C
Reverse Voltage Per Dice	VR	5	V
Operating Temp.	Topr	-35 ~ +85	°C
Storage Temp.	Tstg	-35 ~ +85	°C
Solder temperature 1/16 inch below seating plane for 3 seconds at 260°C			

■ Electro-optical Characteristics -

(Ta=25°C)

Parameter	Symbol	Min.	Typ.	Max.	Unit	Condition
Forward Voltage Per Segment	VF	-	2.1	2.8	V	IF=20mA
Luminous Intensity Per Segment	Iv	-	3900	-	ucd	IF=10mA
Peak Emission Wavelength	λ_p	-	568	-	nm	IF=20mA
Dominant Wavelength	λ_d	-	572	-	nm	IF=20mA
Spectrum Radiation Bandwidth	$\Delta \lambda$	-	30	-	nm	IF=20mA
Reverse Current	IR	-	-	100	μ A	VR=5V
Luminous Intensity Matching Ratio	IV-m	-	-	2:1		Ip=80mA 1/16Duty



Model No : CSM-57071G/CSM-57081G

Typical Electrical / Optical Characteristics Curves -

(Ta = 25°C Unless Otherwise Noted)

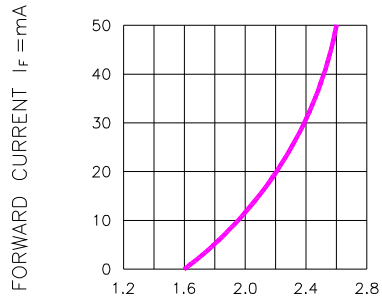

FORWARD VOLTAGE (V_F)—VOLTS

Fig.1 FORWARD CURRENT VS. FORWARD VOLTAGE

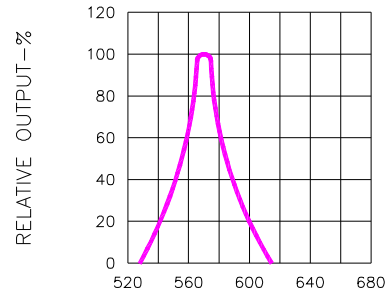

WAVELENGTH (λ)—nm

Fig.2 SPECTRAL RESPONSE

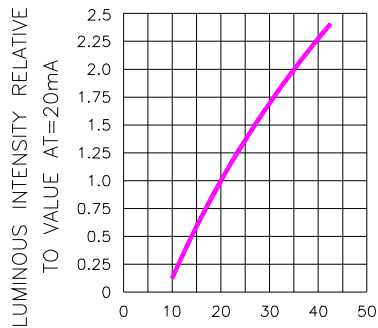

I_F—FORWARD CURRENT—mA

Fig.3 RELATIVE LUMINOUS INTENSITY VS. FORWARD CURRENT

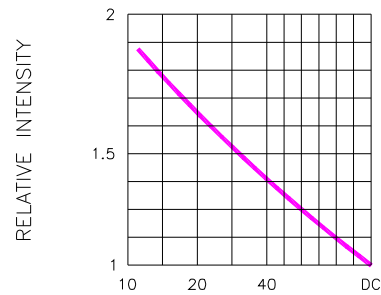

DUTY CYCLE % PER SEGMENT
(AVERAGE I_F=10mA)

Fig.5 LUMINOUS INTENSITY VS. DUTY CYCLE

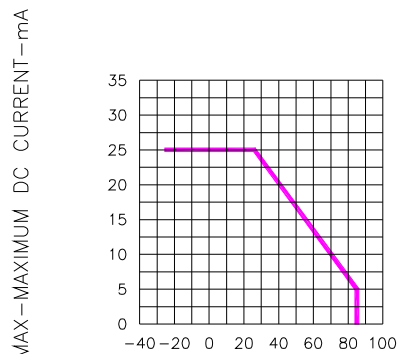

T_A AMBIENT TEMPERATURE °C

Fig.4 MAXIMUM ALLOWABLE DC CURRENT PER SEGMENT VS. A FUNCTION OF AMBIENT TEMPERATURE

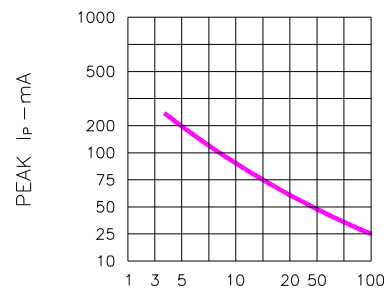

DUTY CYCLE %

Fig.6 MAX PEAK CURRENT VS. DUTY CYCLE %
(REFRESH RATE f=1 KHz)



**CHINA
SEMICONDUCTOR
CORPORATION**

Spec. No.	PS-ND-0710
Rev.	A

Model No : CSM-57071G/CSM-57081G

■ Package Dimensions

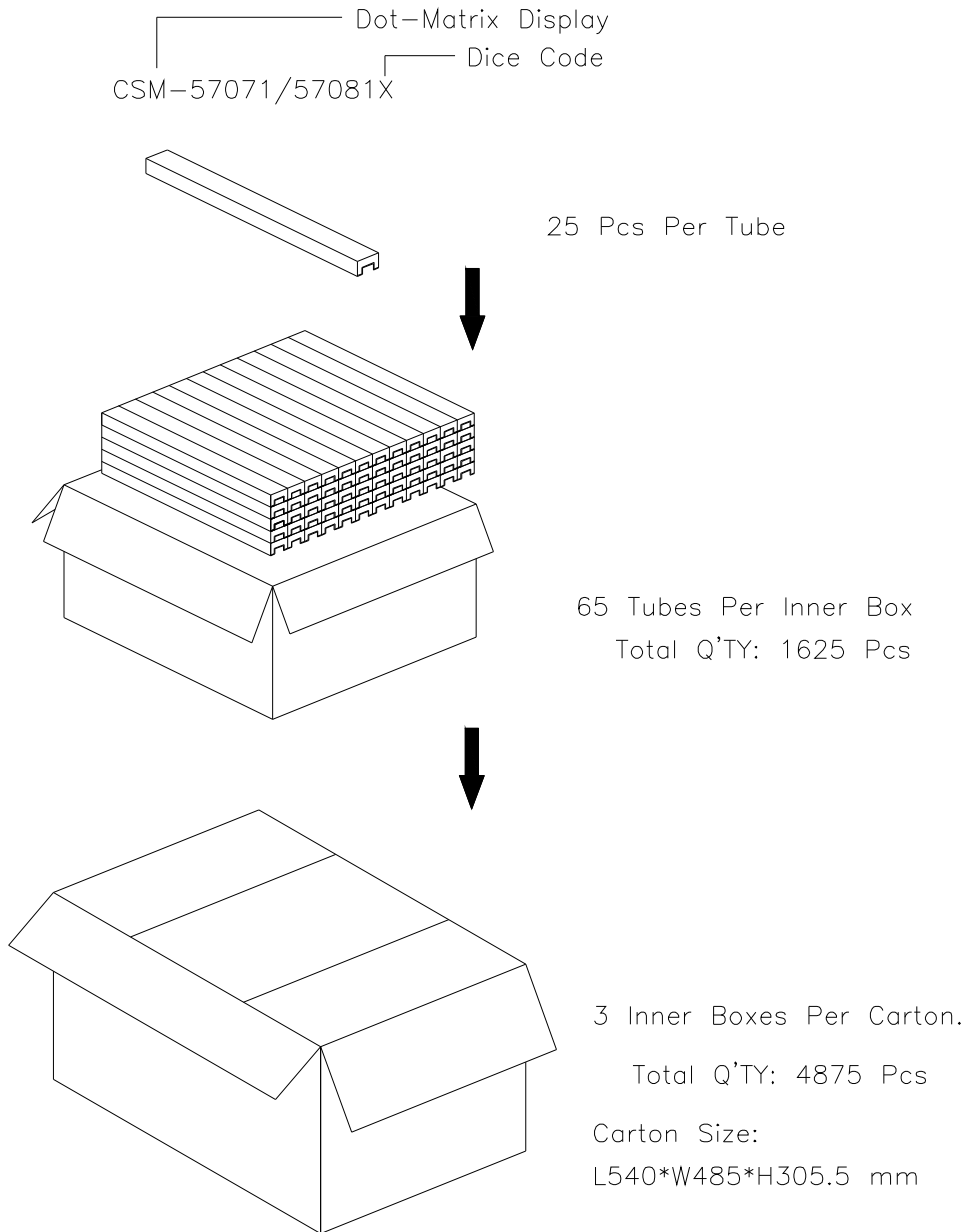

Note: The specifications are subject to change without notice. Please contact us for updated information.